

Pattern: 1950 car 001

Archive: Onyx Earl

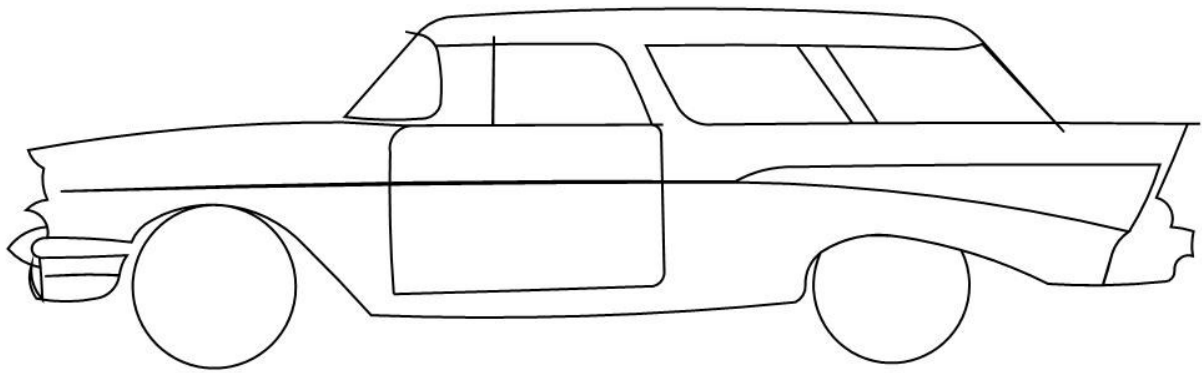

Pattern: 1950 car 002

Archive: Onyx Earl

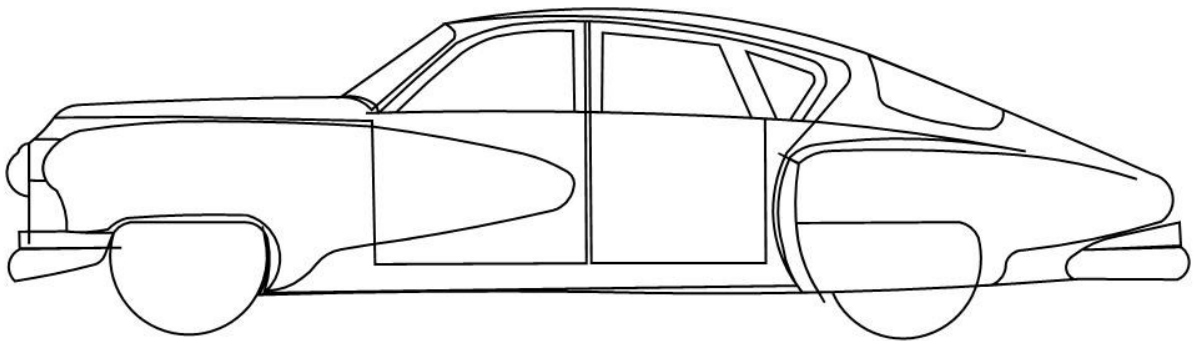

Pattern: 1950 car 003

Archive: Onyx Earl

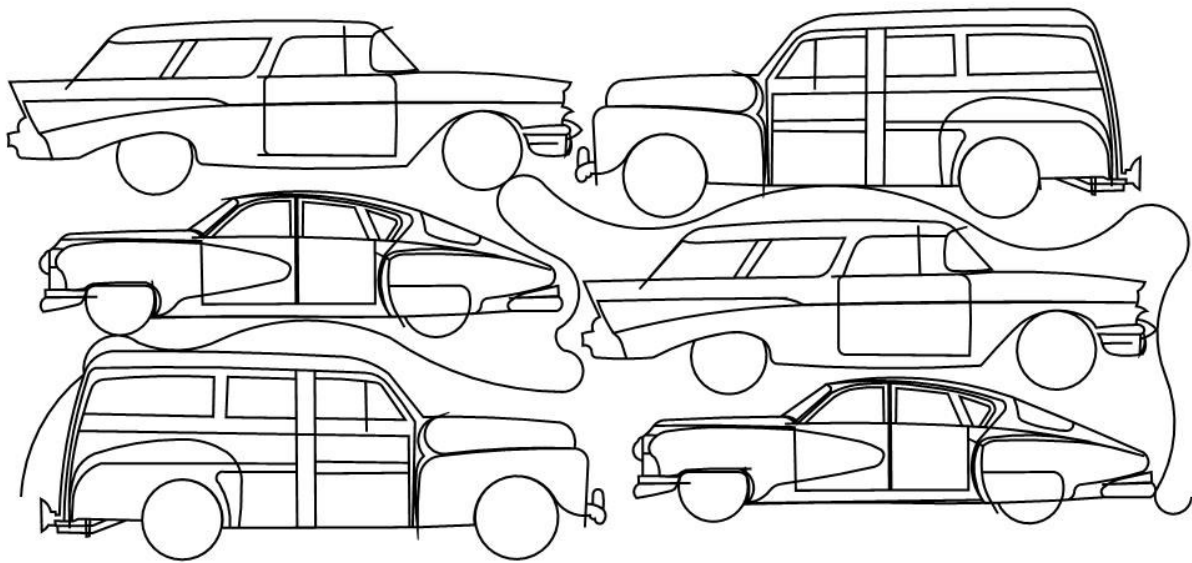

Pattern: 1950 car pano 001

Archive: Onyx Earl

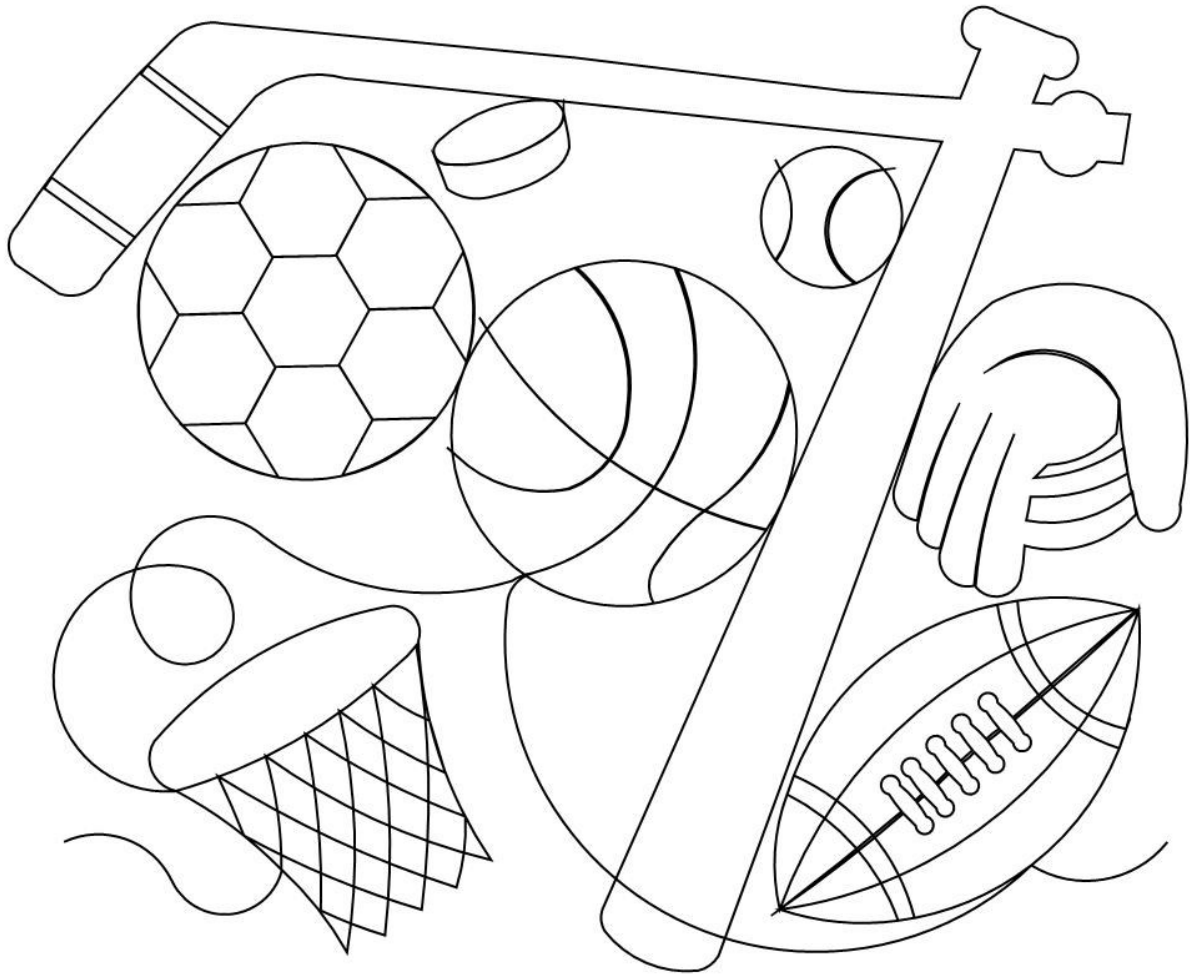

Pattern: all sports pano 013

Archive: Onyx Earl



Pattern: athos brd crn 001a

Archive: Onyx Earl



Pattern: athos brd crn 001b

Archive: Onyx Earl

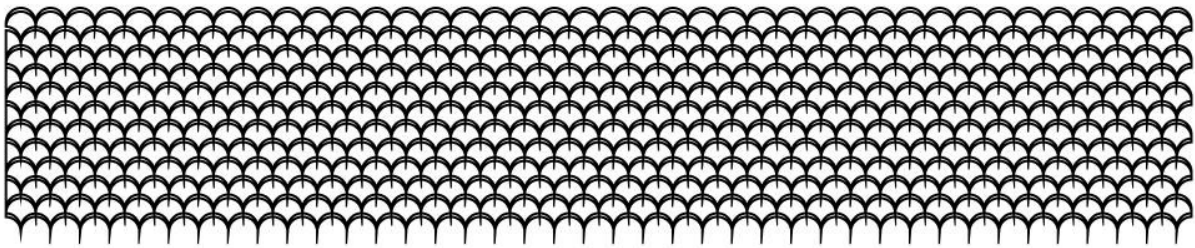

Pattern: background fill 003 67.12

Archive: Onyx Earl

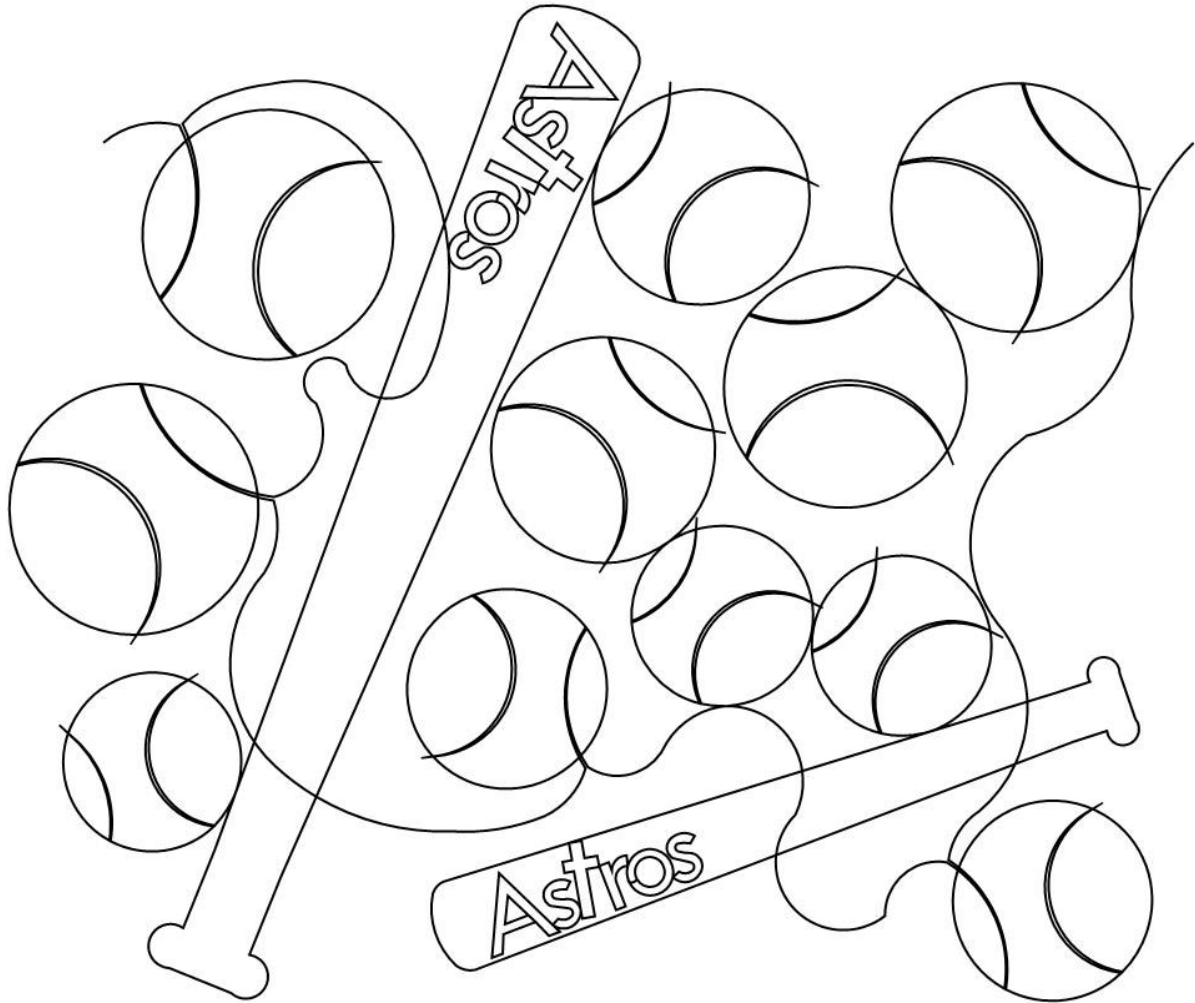

Pattern: baseball fun 005 astros

Archive: Onyx Earl

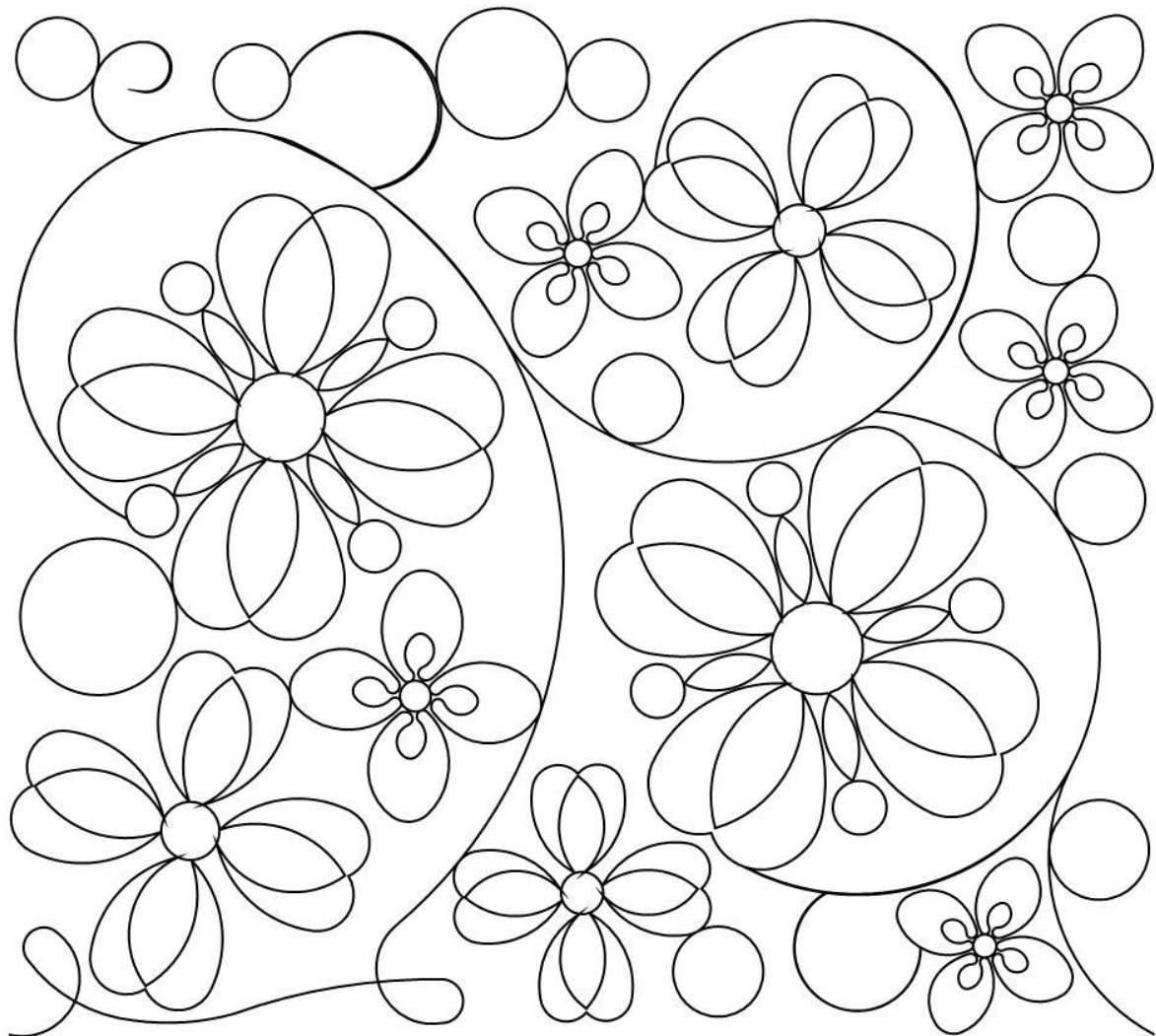

Pattern: bday 2014 pano sq 002

Archive: Onyx Earl

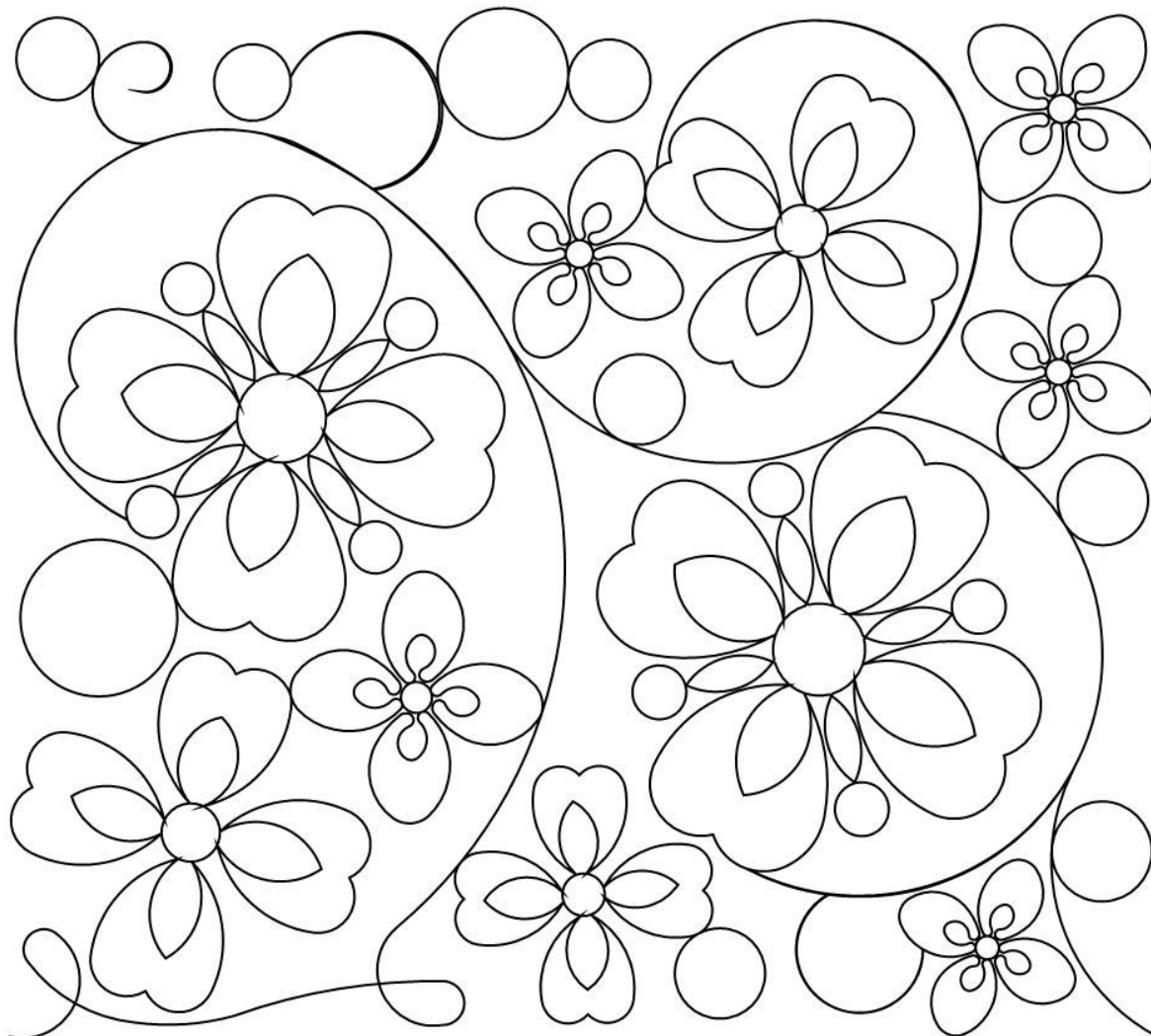

Pattern: bday 2014 pano sq 003

Archive: Onyx Earl

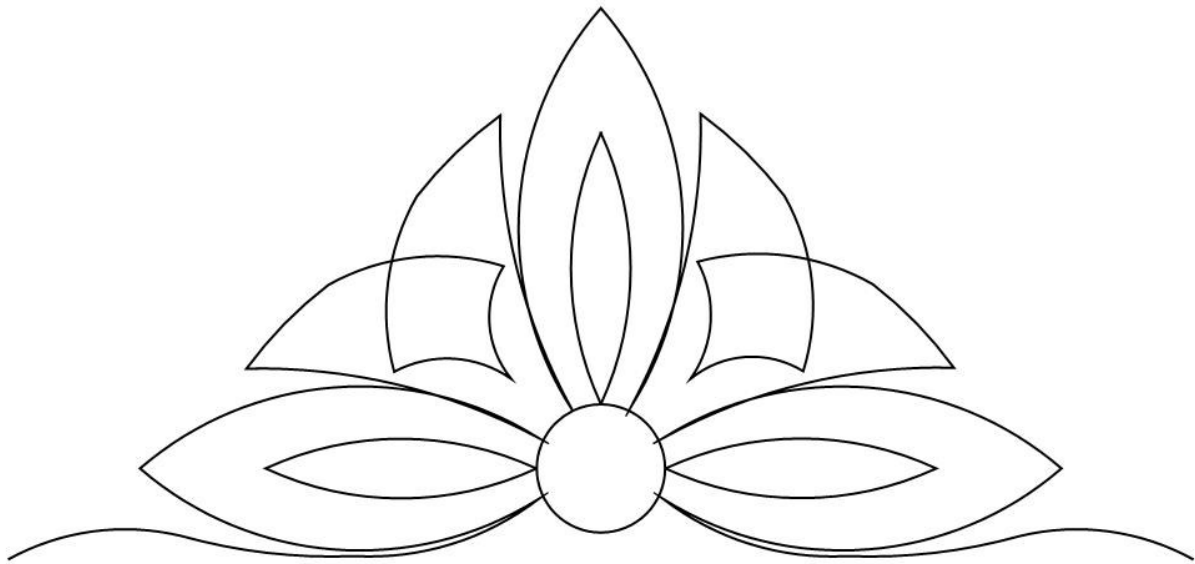

Pattern: beauty p2p tri

Archive: Onyx Earl

Becky Rebecca
Bug Beck Bee

Pattern: becky border 001

Archive: Onyx Earl



Pattern: becky border 002

Archive: Onyx Earl



Pattern: becky border 003

Archive: Onyx Earl

Becky Bug Rebecca Beck Bee

Pattern: becky border 004

Archive: Onyx Earl

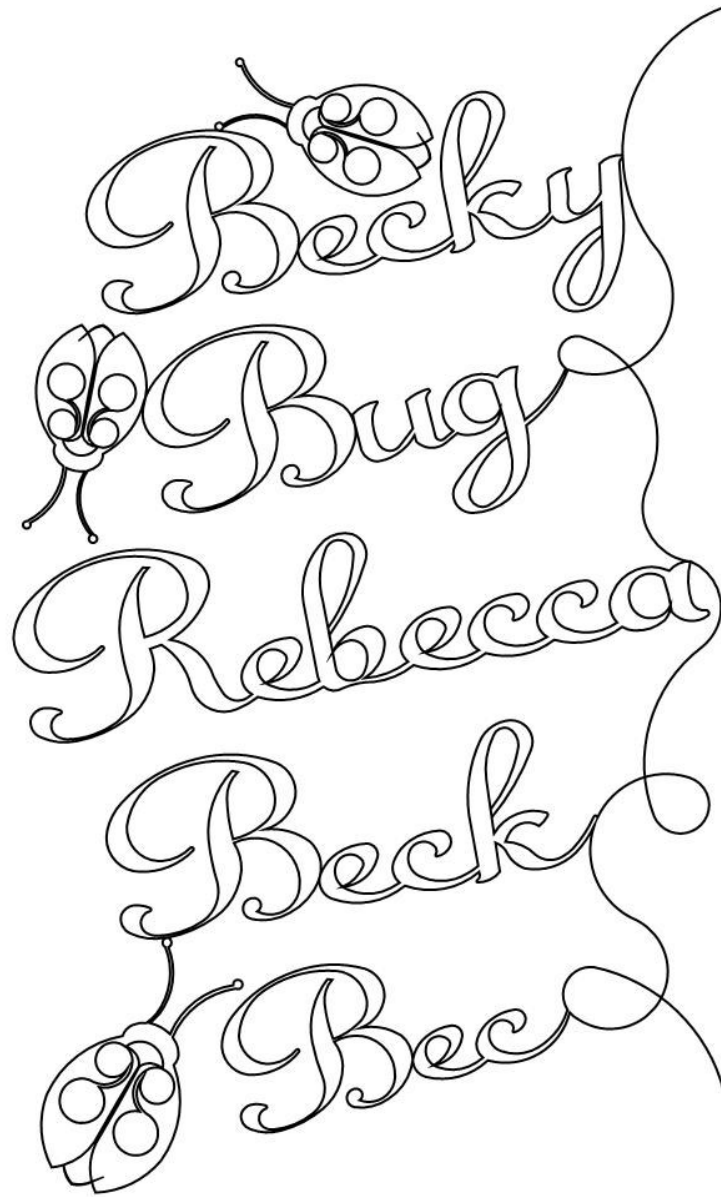

Pattern: becky border 005

Archive: Onyx Earl

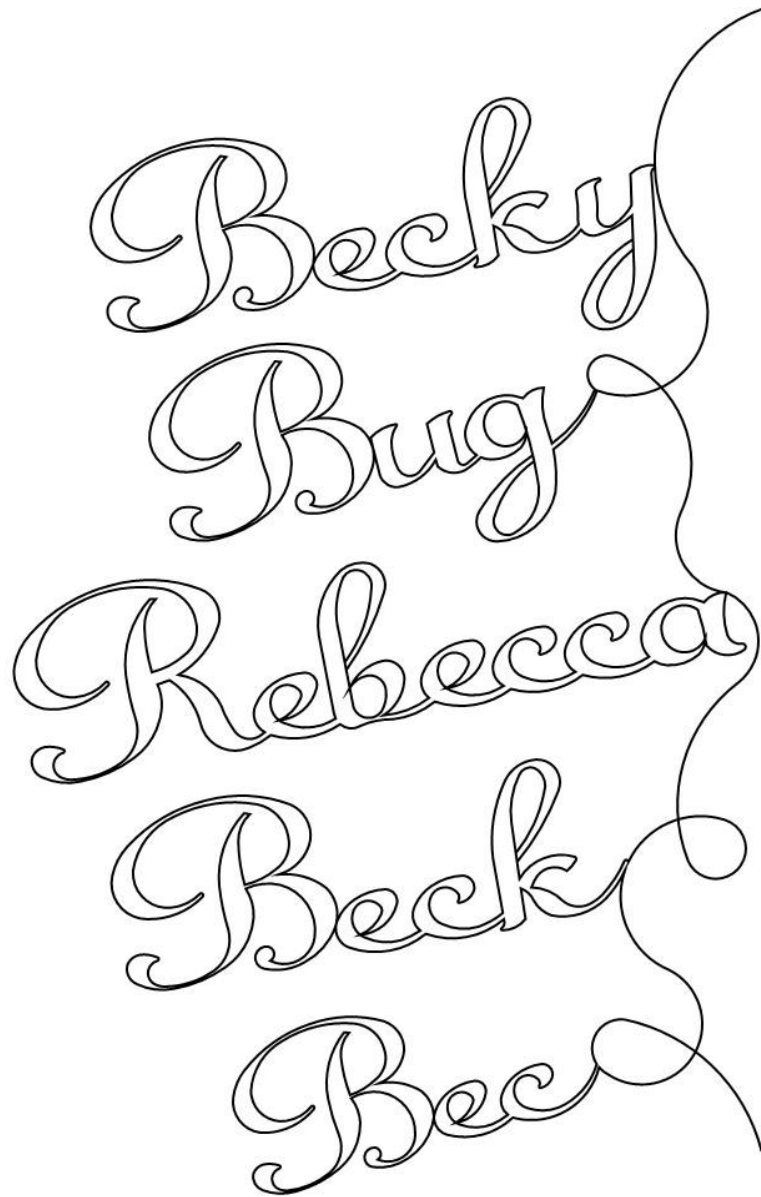

Pattern: becky border 006

Archive: Onyx Earl



Pattern: bee hive 001

Archive: Onyx Earl

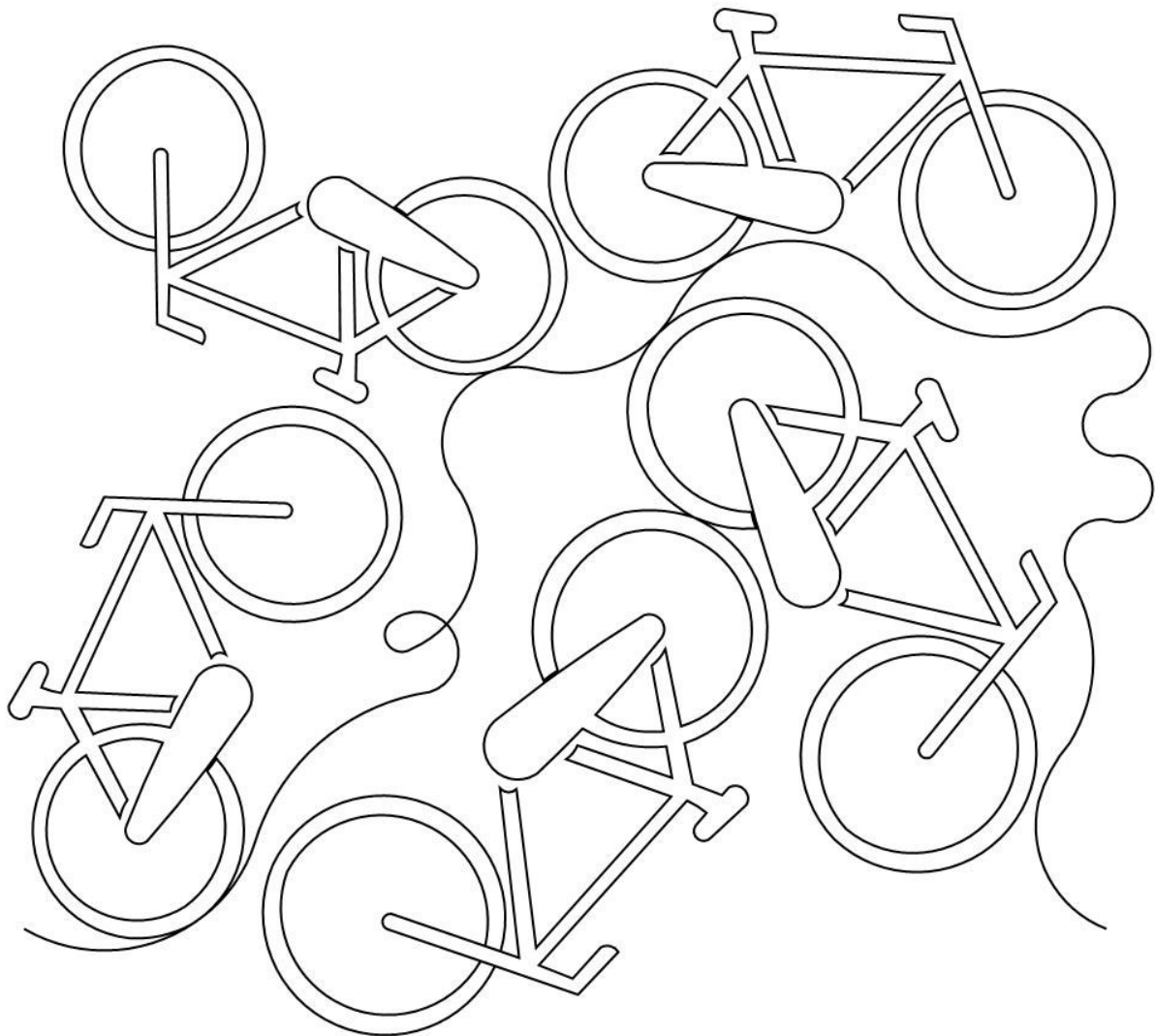

Pattern: bike pano 002

Archive: Onyx Earl

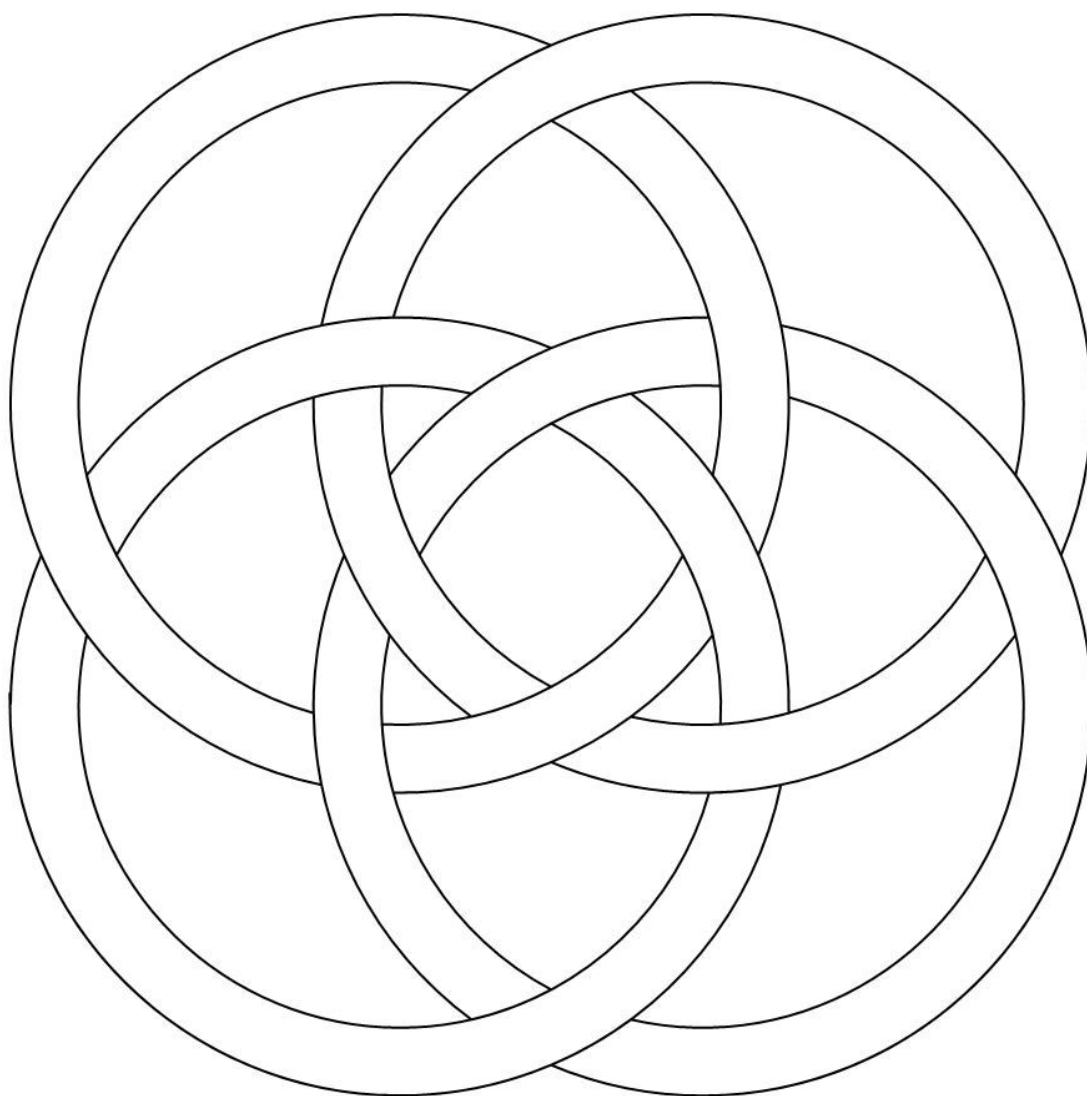

Pattern: bitty block 030 pano

Archive: Onyx Earl

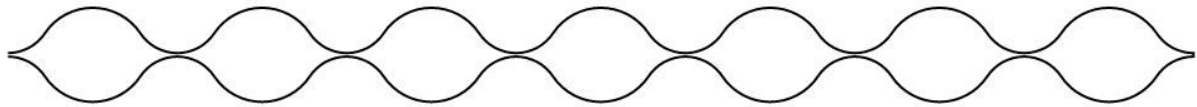

Pattern: bowman grid

Archive: Onyx Earl

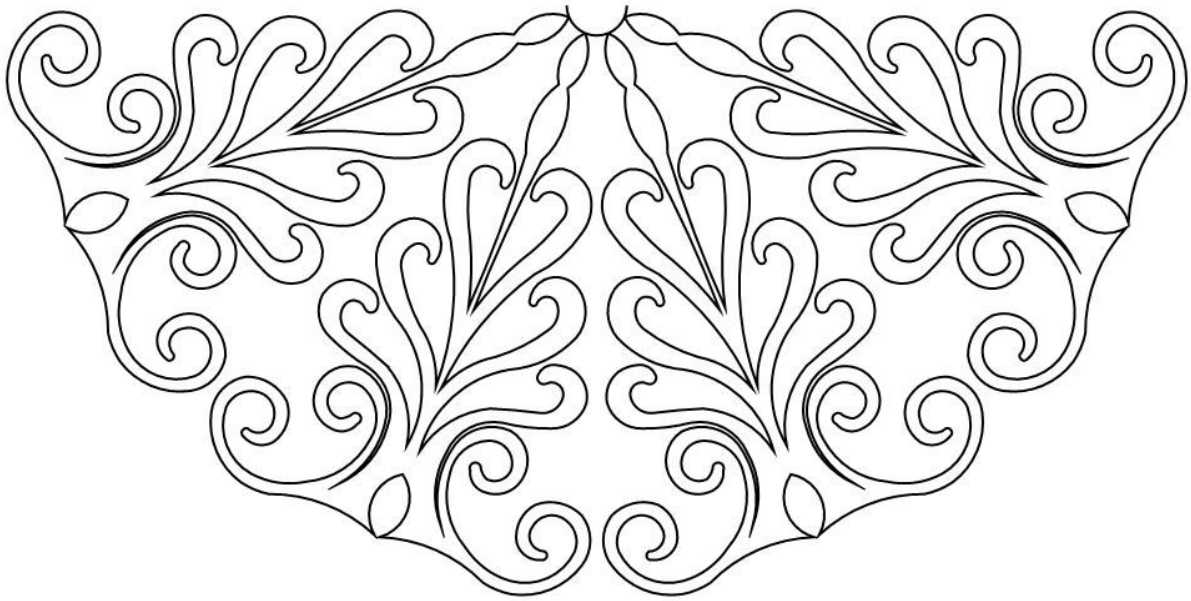

Pattern: bronte 013 half 1

Archive: Onyx Earl

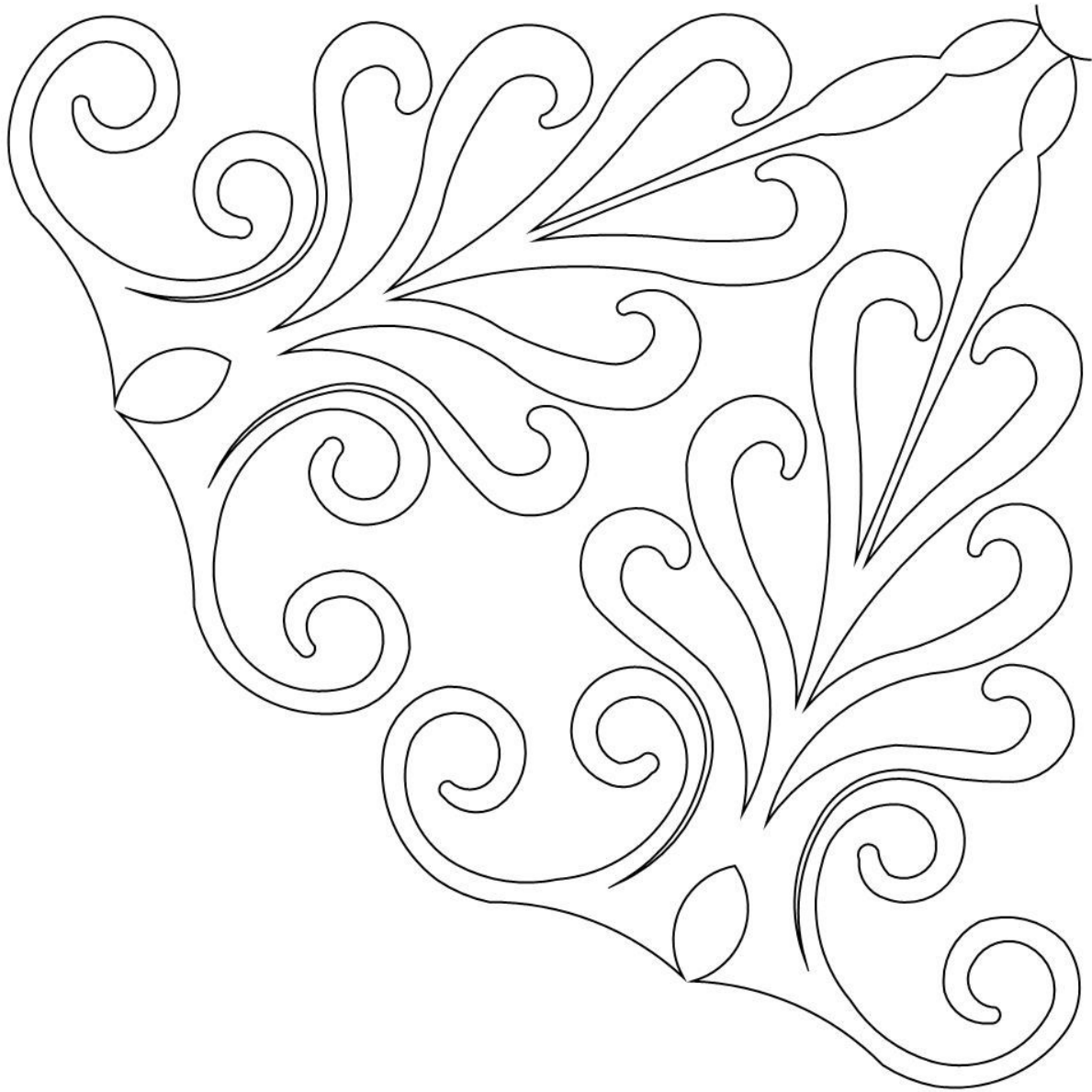

Pattern: bronte 013 qtr 1

Archive: Onyx Earl

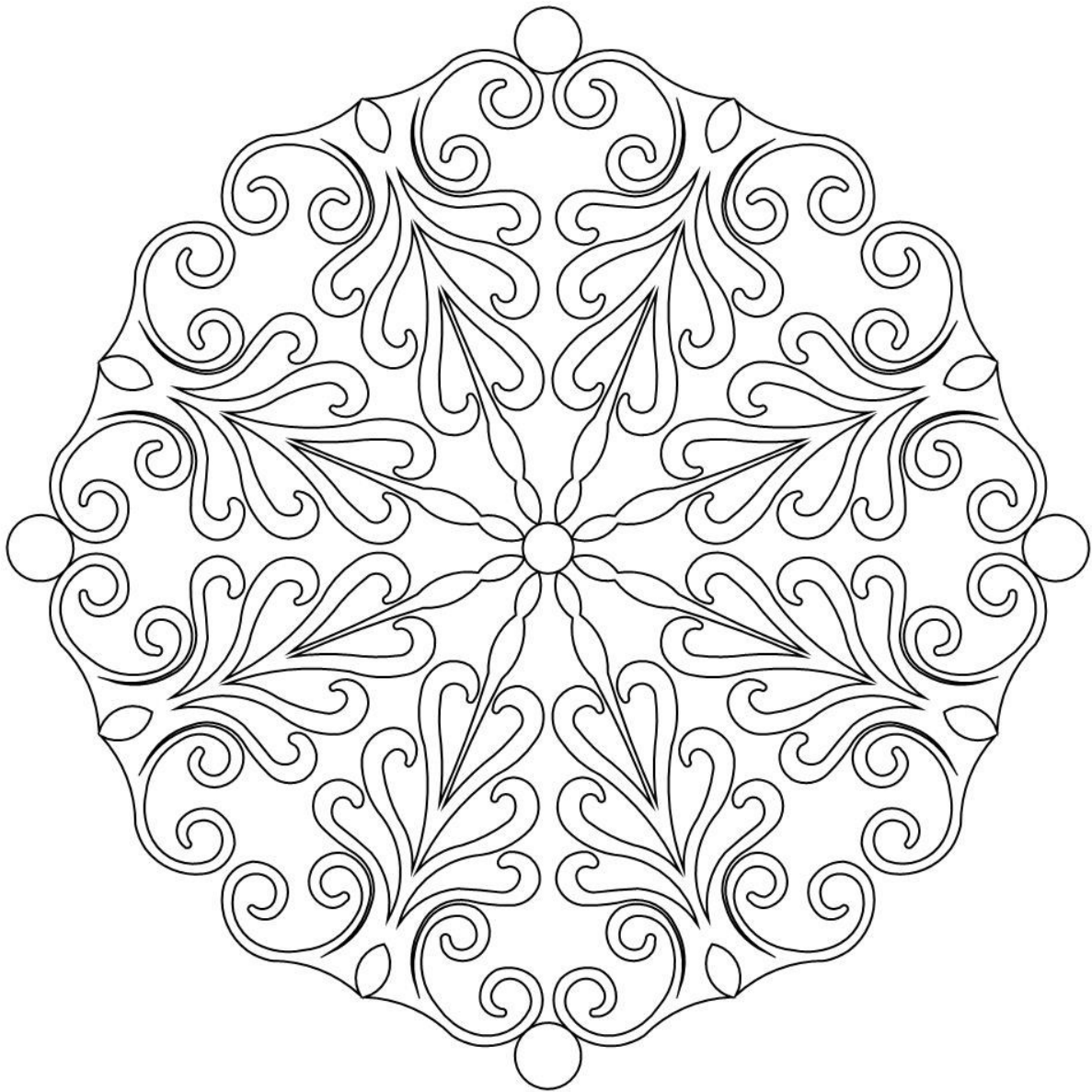

Pattern: bronte 014

Archive: Onyx Earl

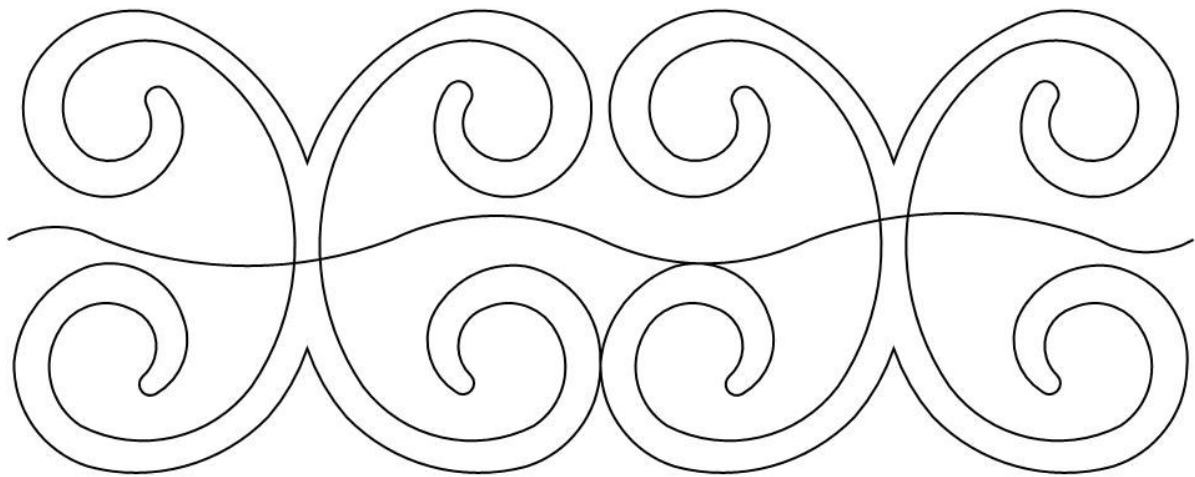

Pattern: bronte border 006

Archive: Onyx Earl

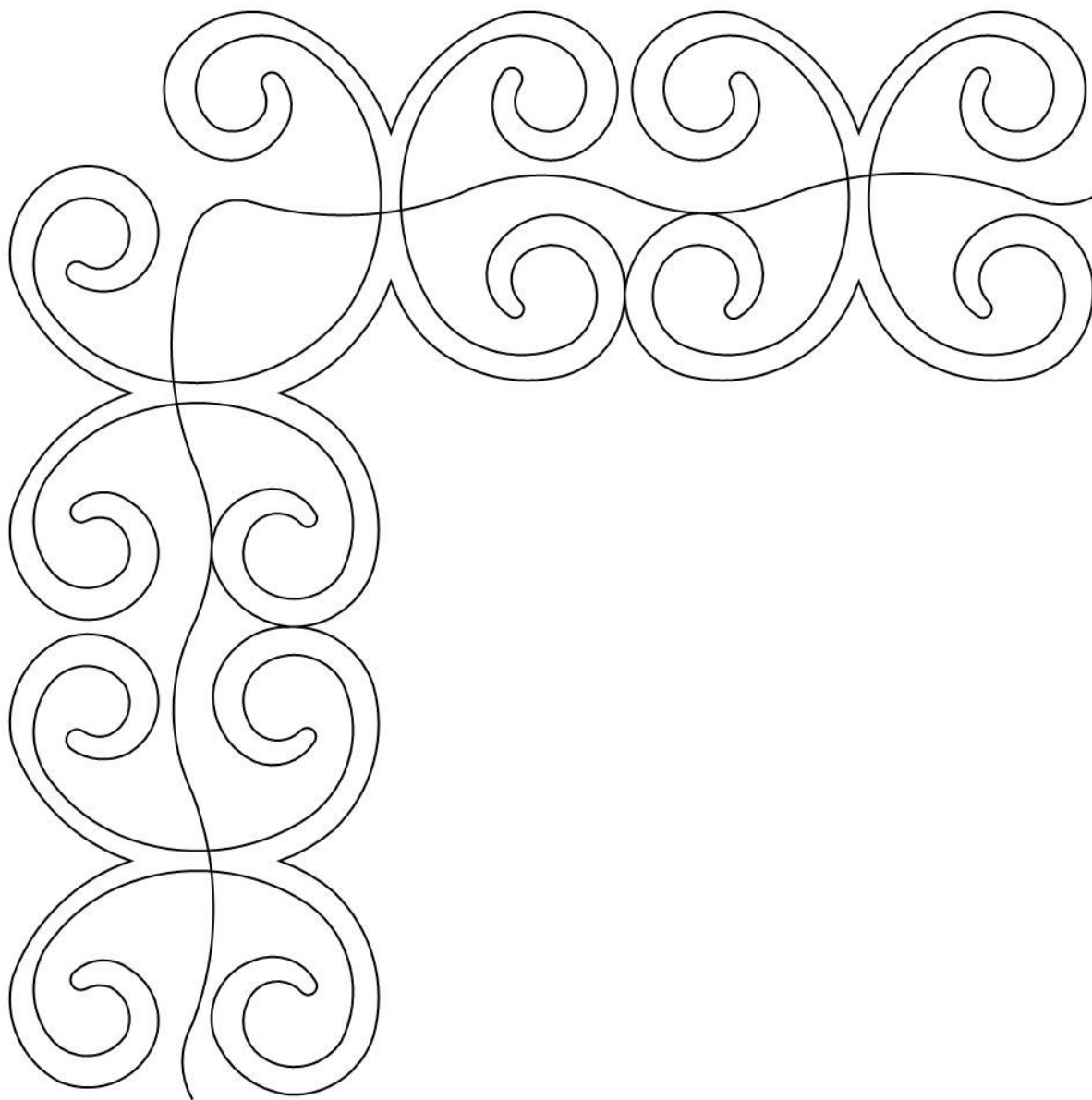

Pattern: bronte brd crn 006

Archive: Onyx Earl

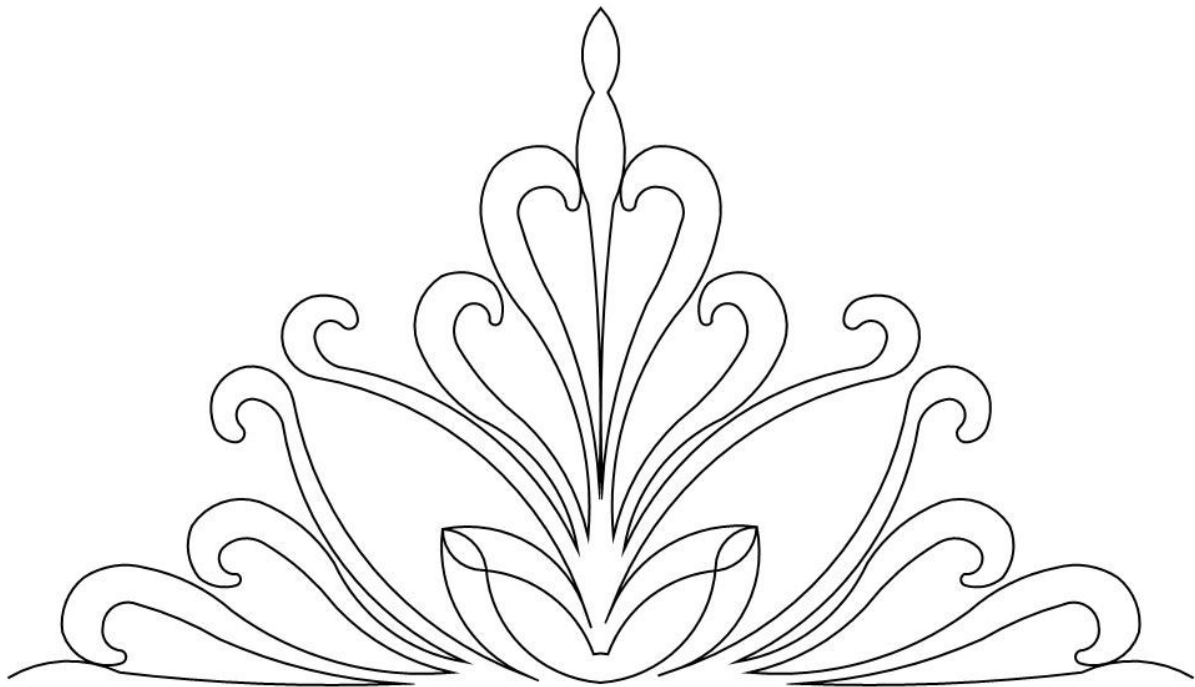

Pattern: bronte p2p 001

Archive: Onyx Earl

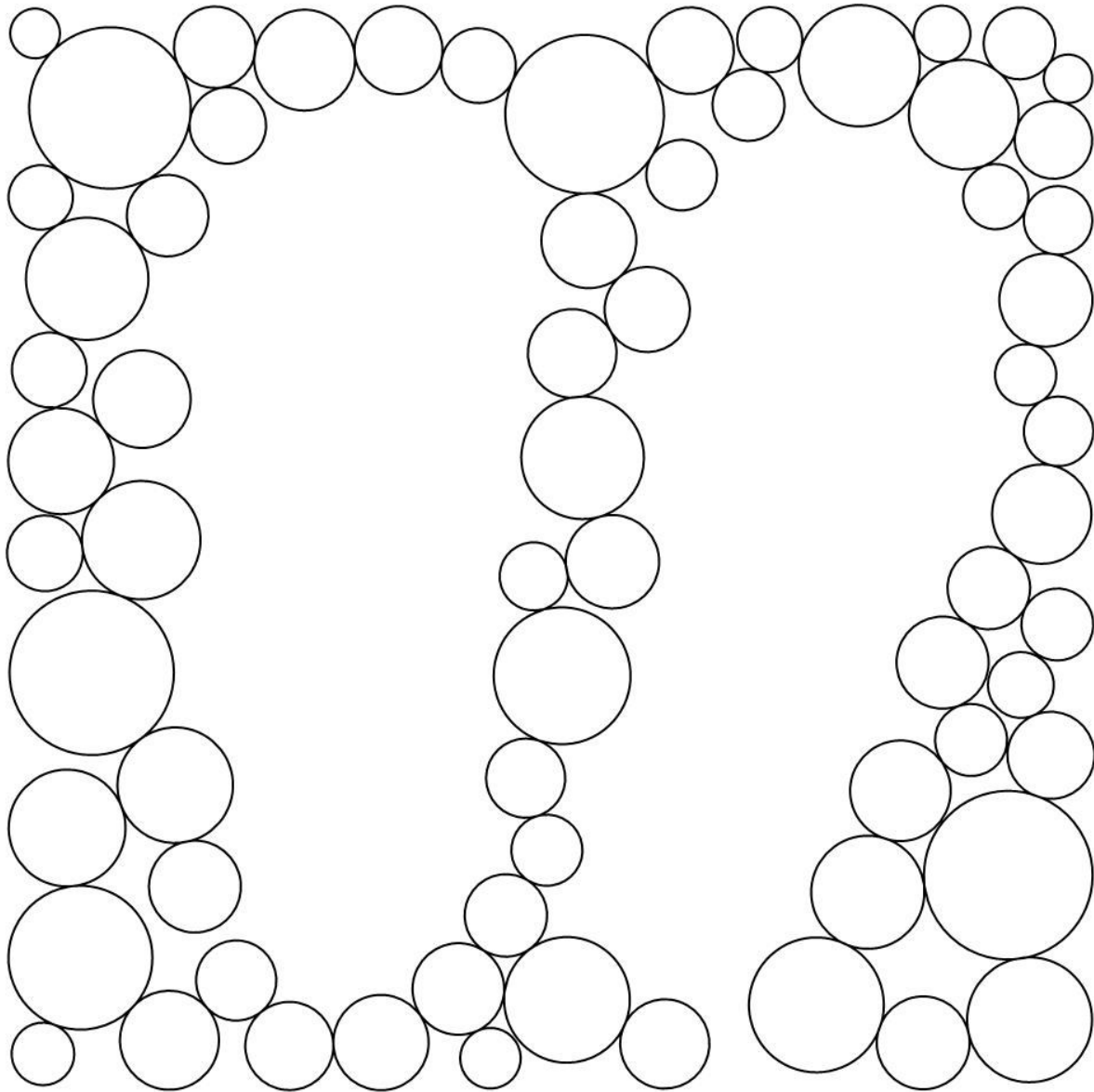

Pattern: bubble flip flop fill

Archive: Onyx Earl



Pattern: bulldog bdr crn 001

Archive: Onyx Earl

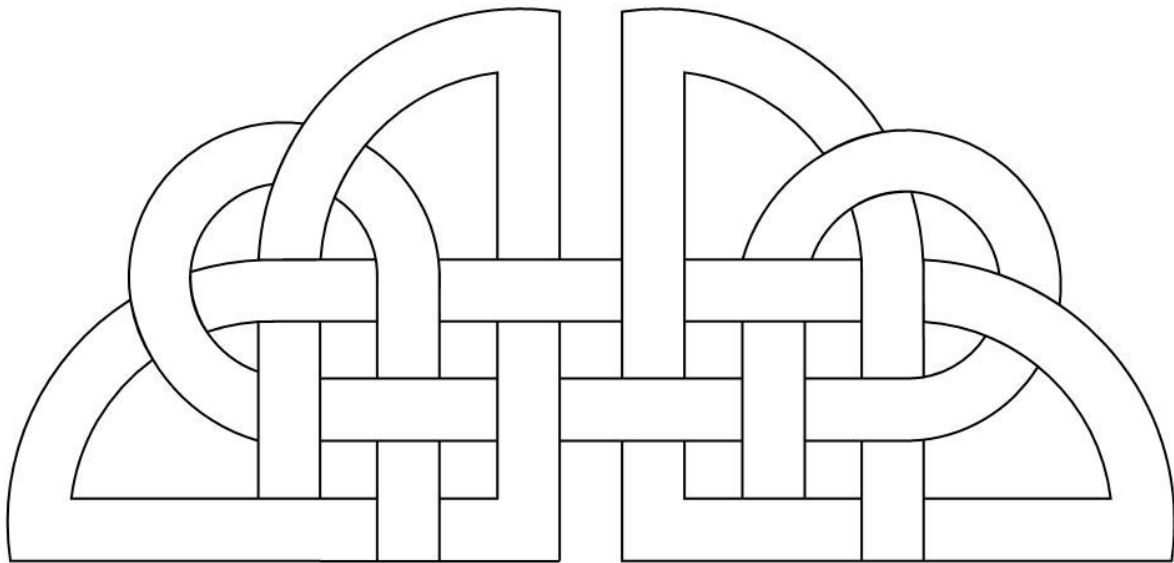

Pattern: celtic circle 001 half

Archive: Onyx Earl

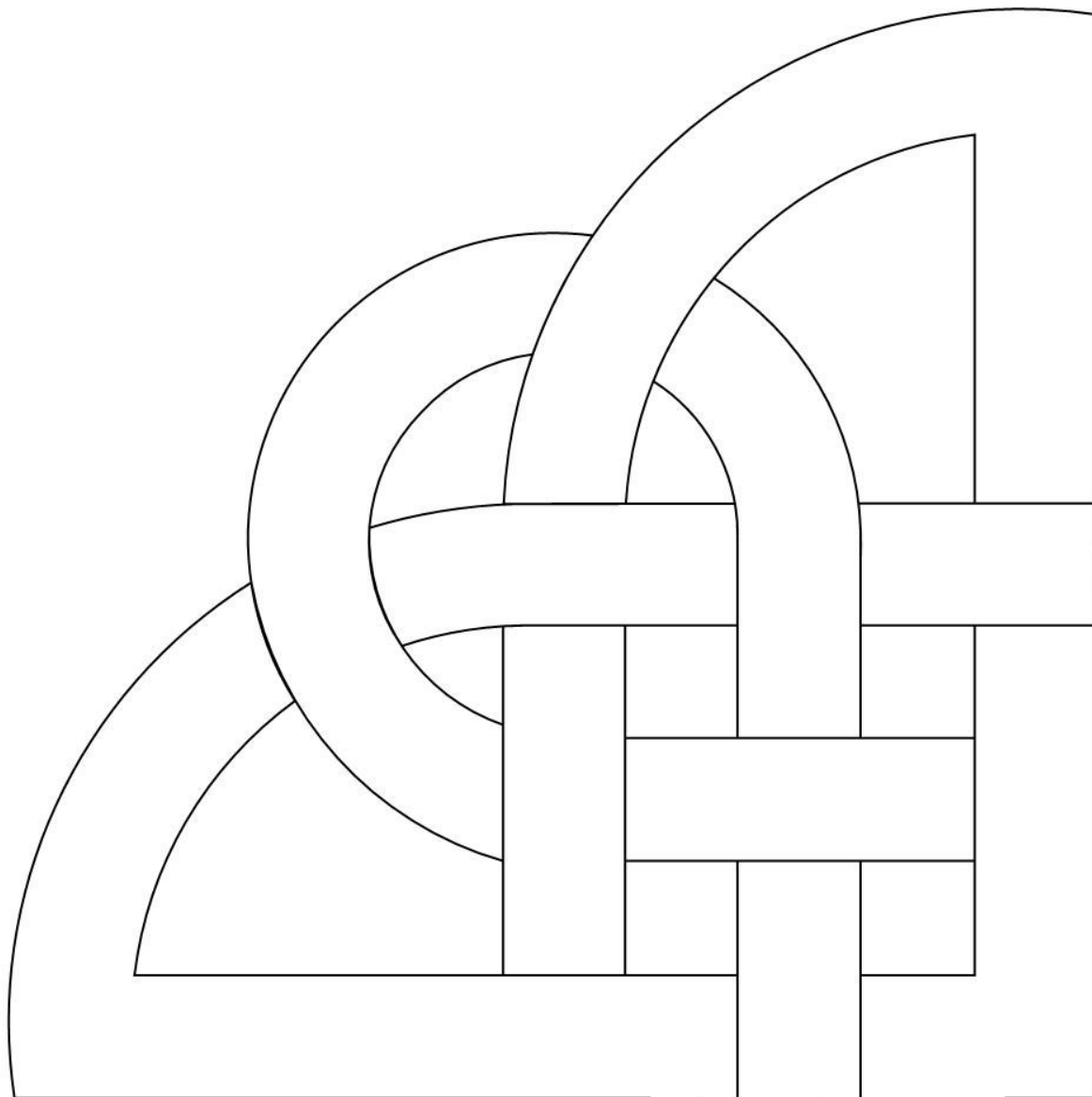

Pattern: celtic circle 001qtr

Archive: Onyx Earl

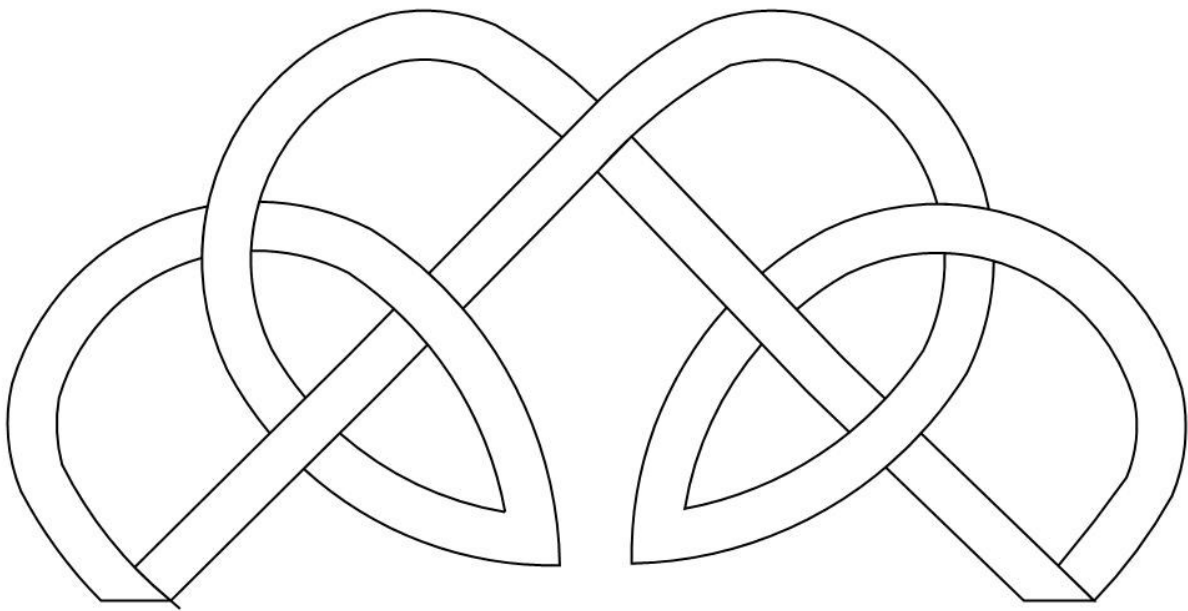

Pattern: celtic knot 5 half 1

Archive: Onyx Earl

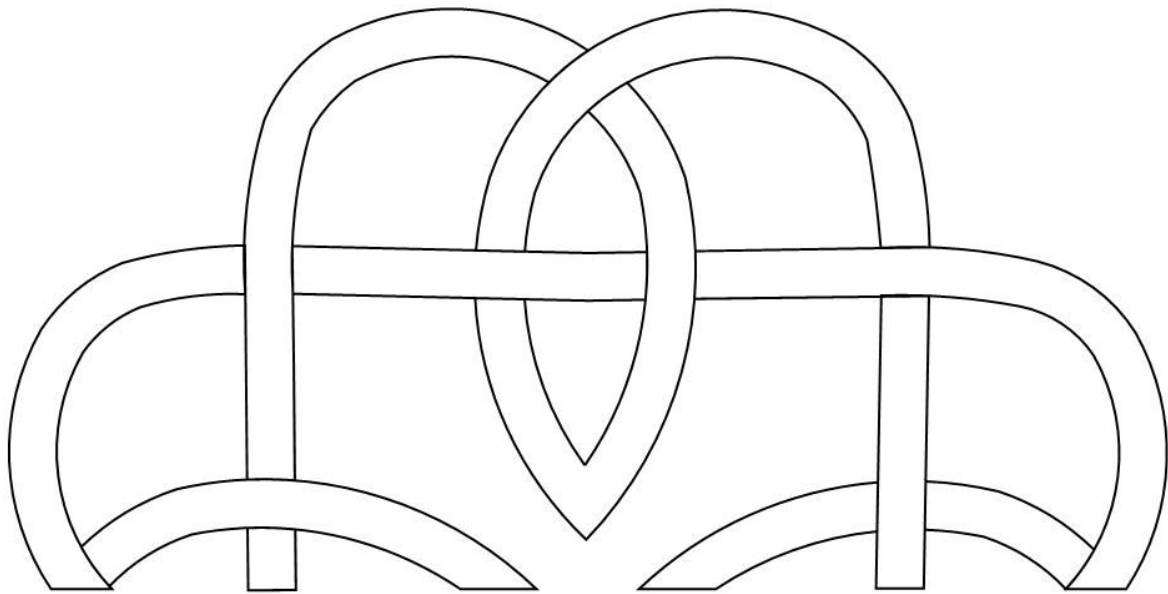

Pattern: celtic knot 5 half 2

Archive: Onyx Earl

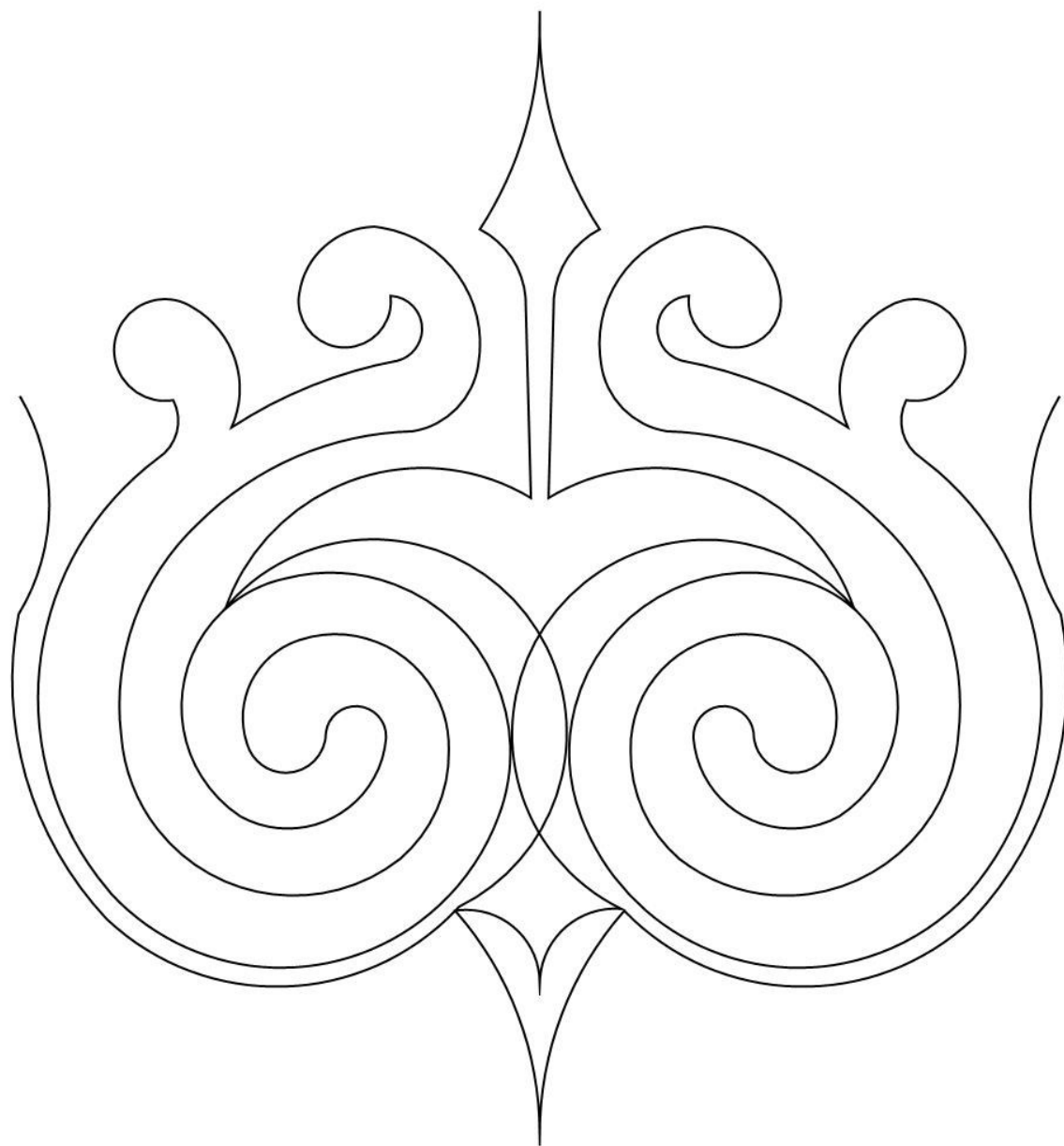

Pattern: chillings alt pano 001

Archive: Onyx Earl

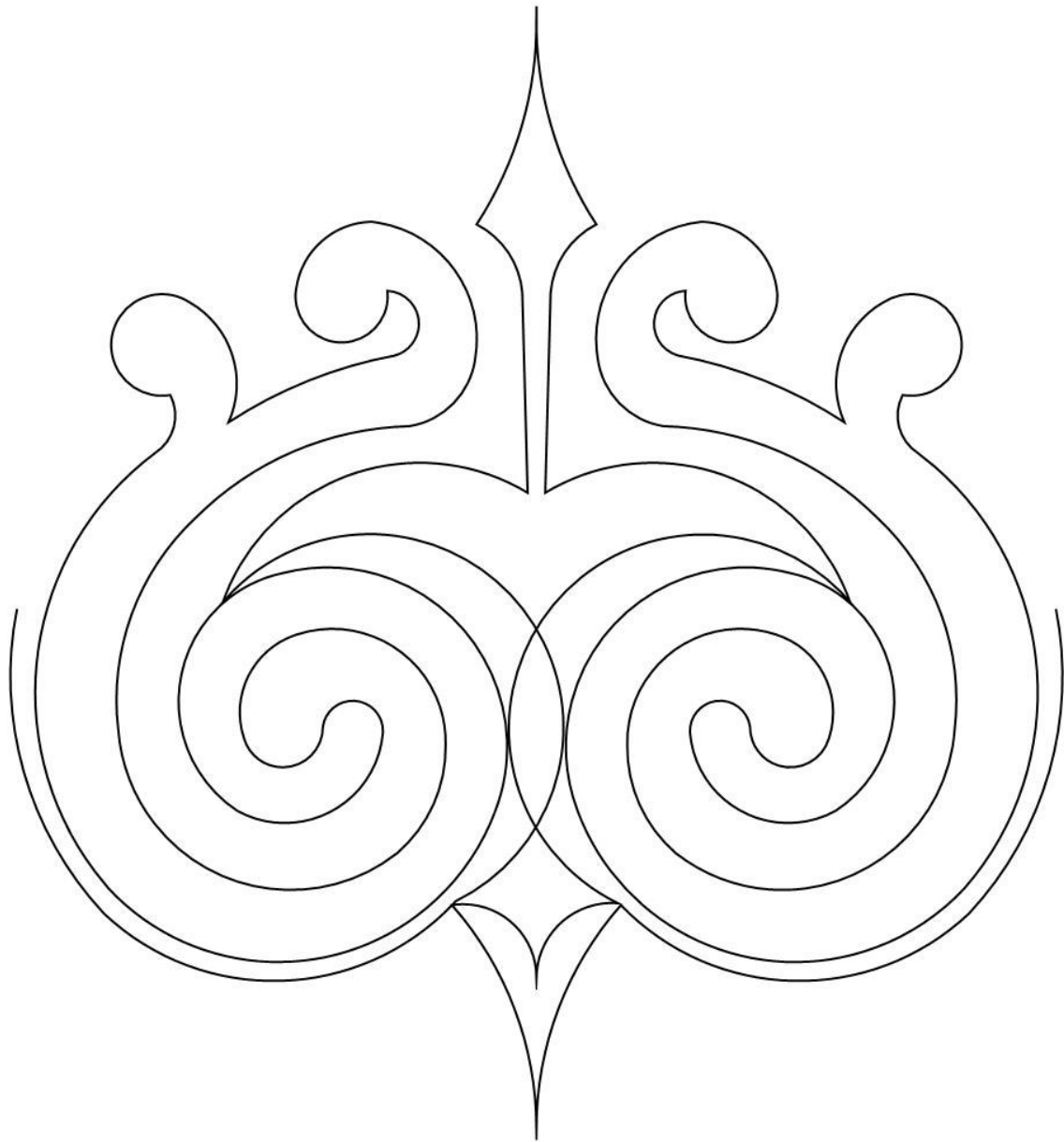

Pattern: chillings alt pano 002

Archive: Onyx Earl

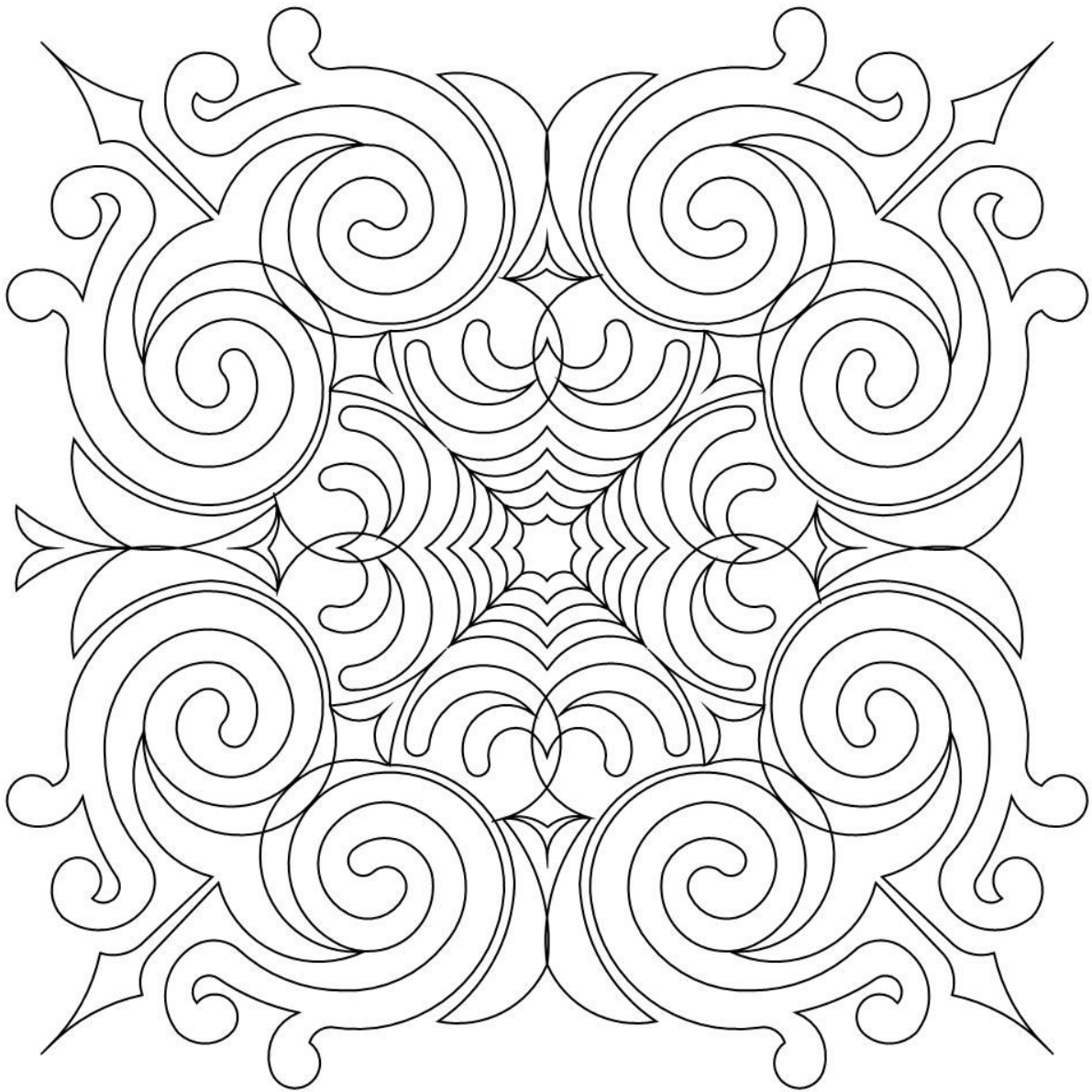

Pattern: chillings block 001

Archive: Onyx Earl

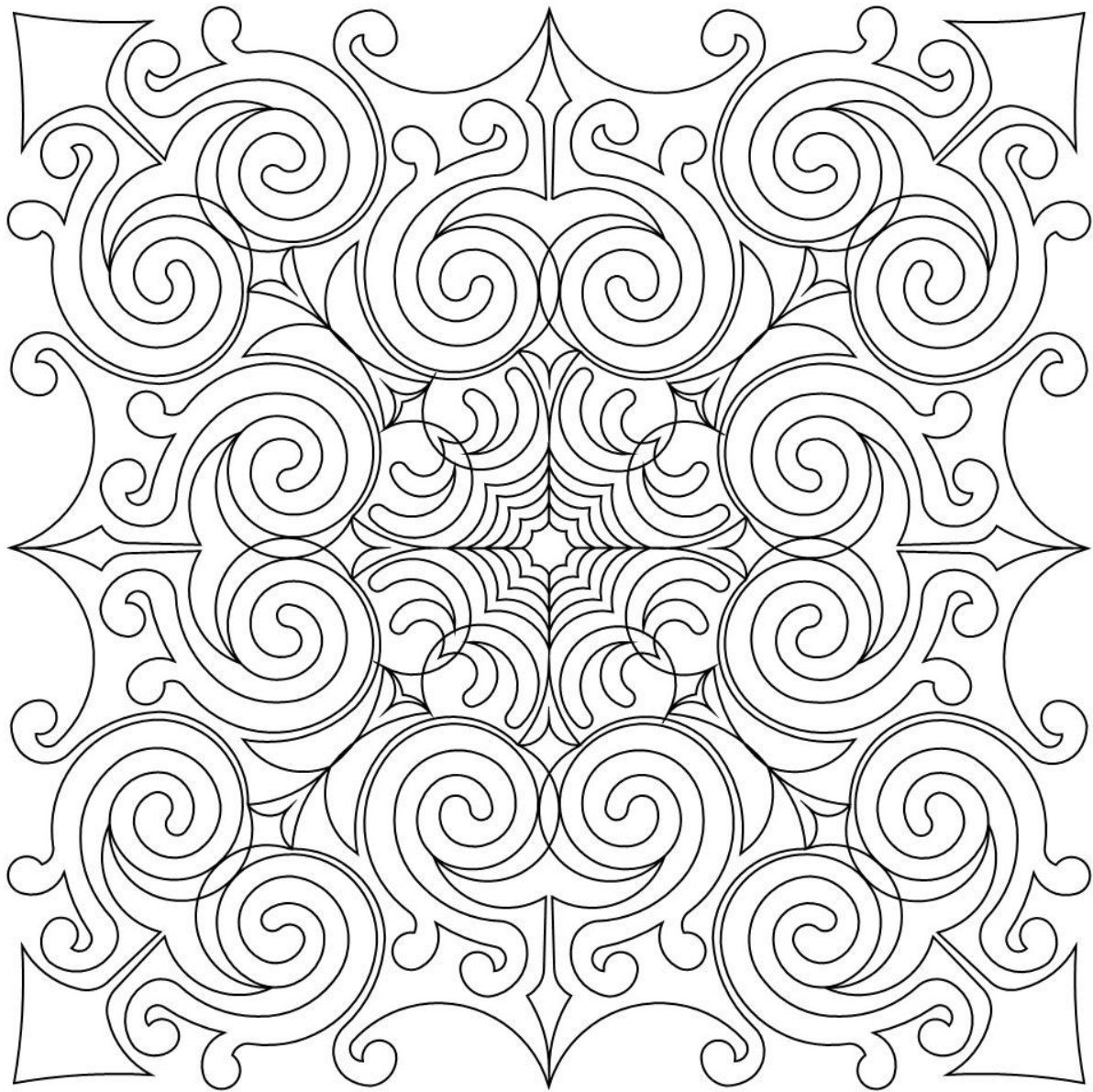

Pattern: chillings block 002

Archive: Onyx Earl

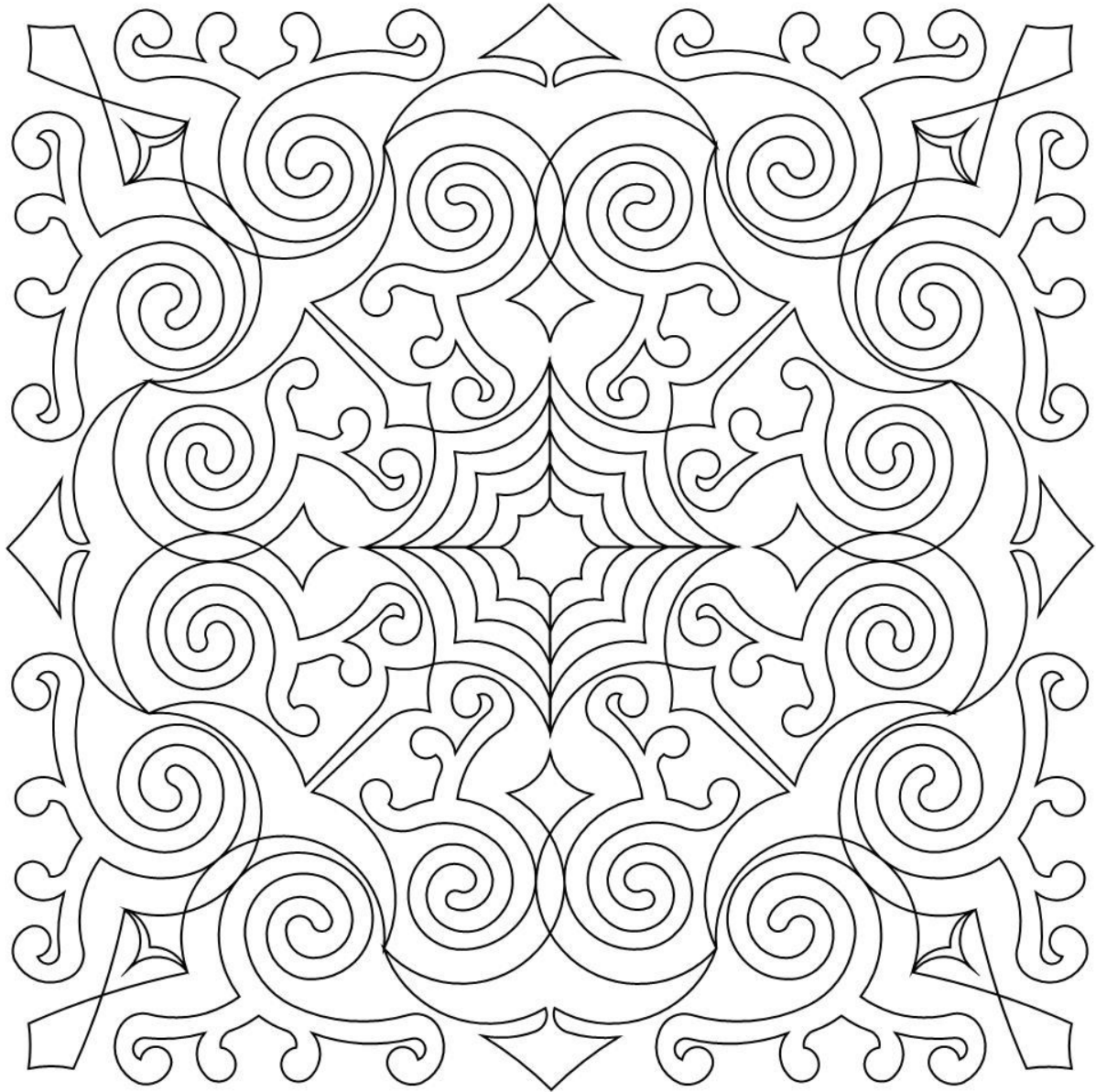

Pattern: chillings block 003

Archive: Onyx Earl

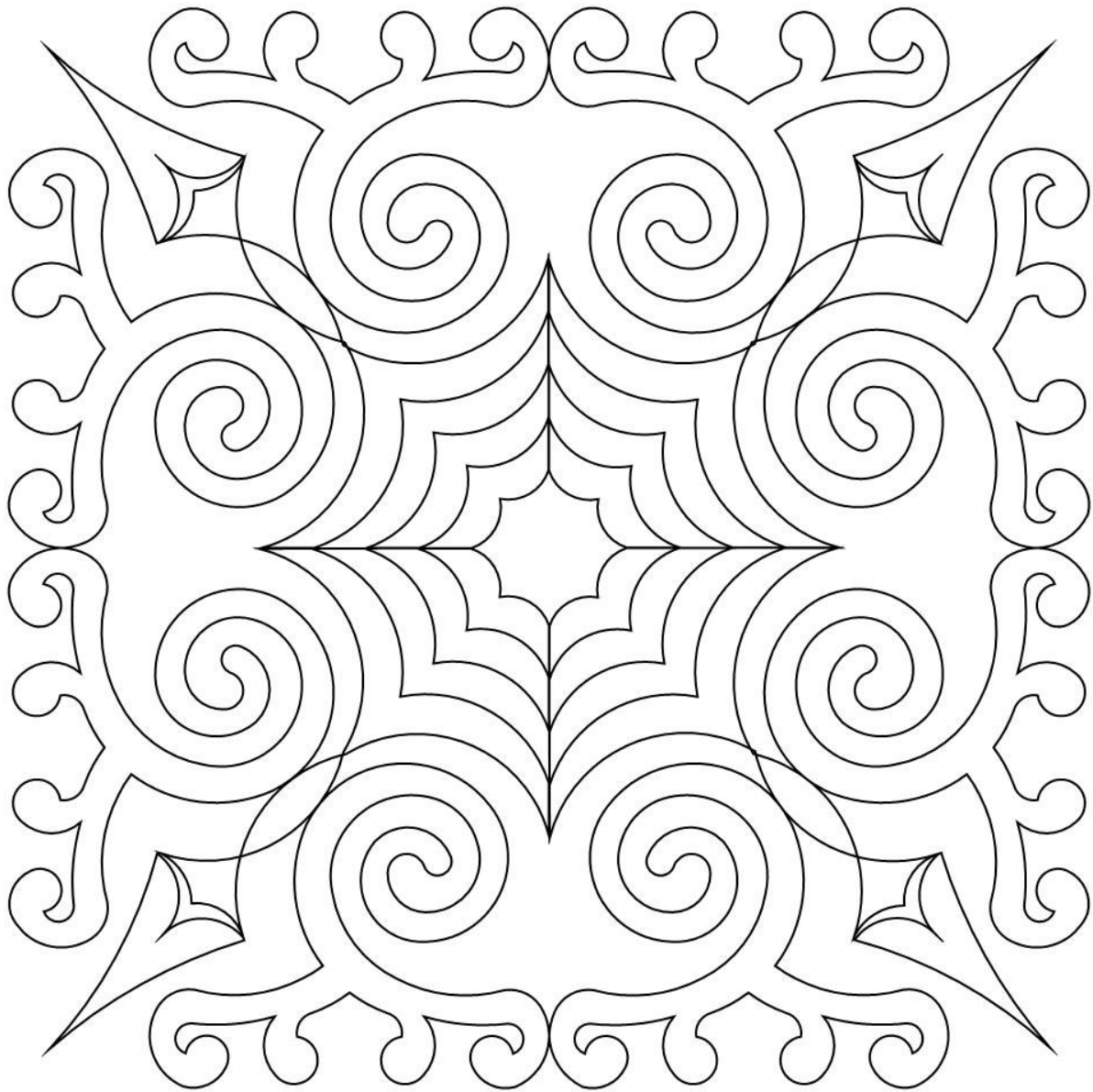

Pattern: chillings block 004

Archive: Onyx Earl

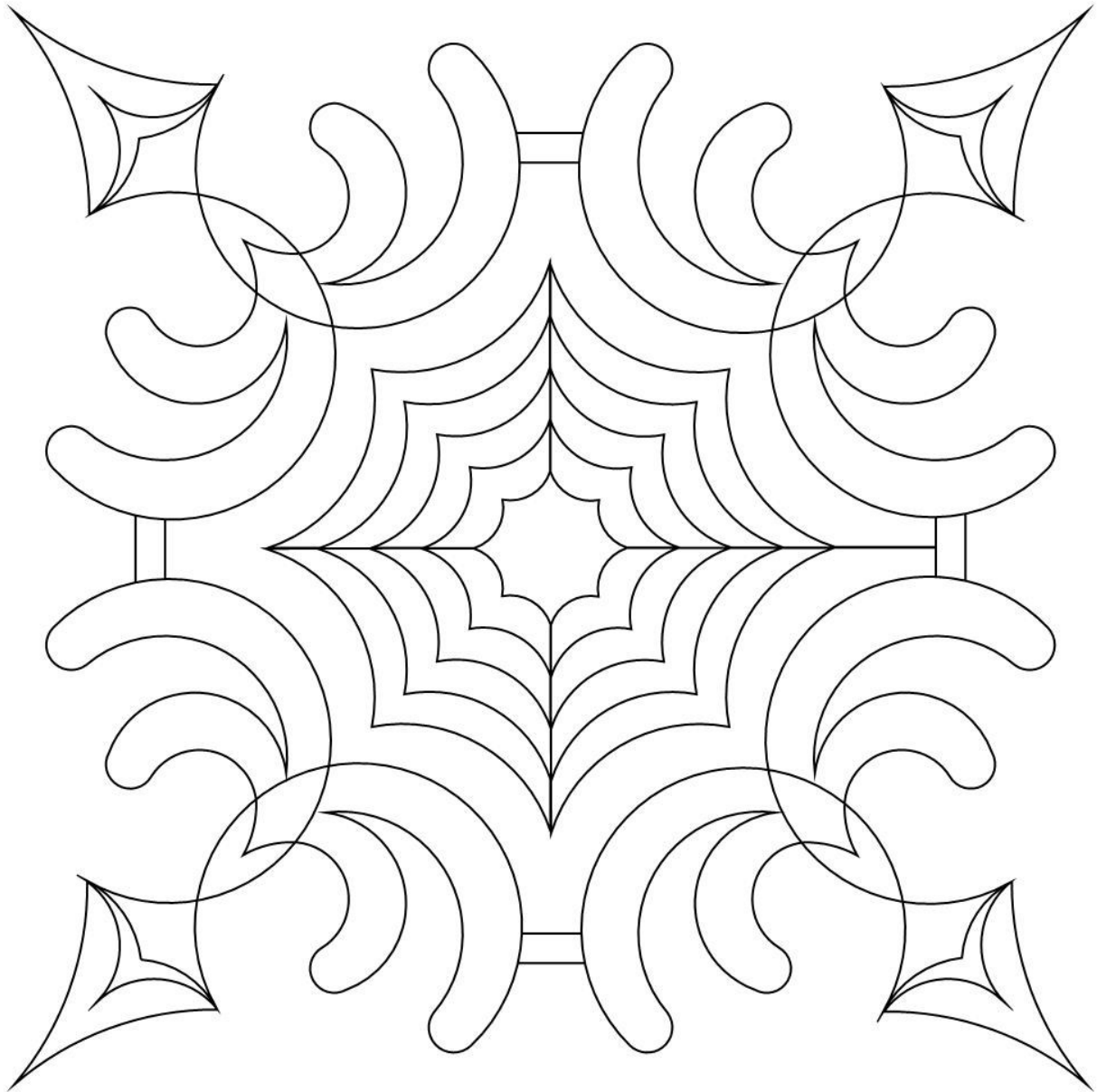

Pattern: chillings block 005

Archive: Onyx Earl

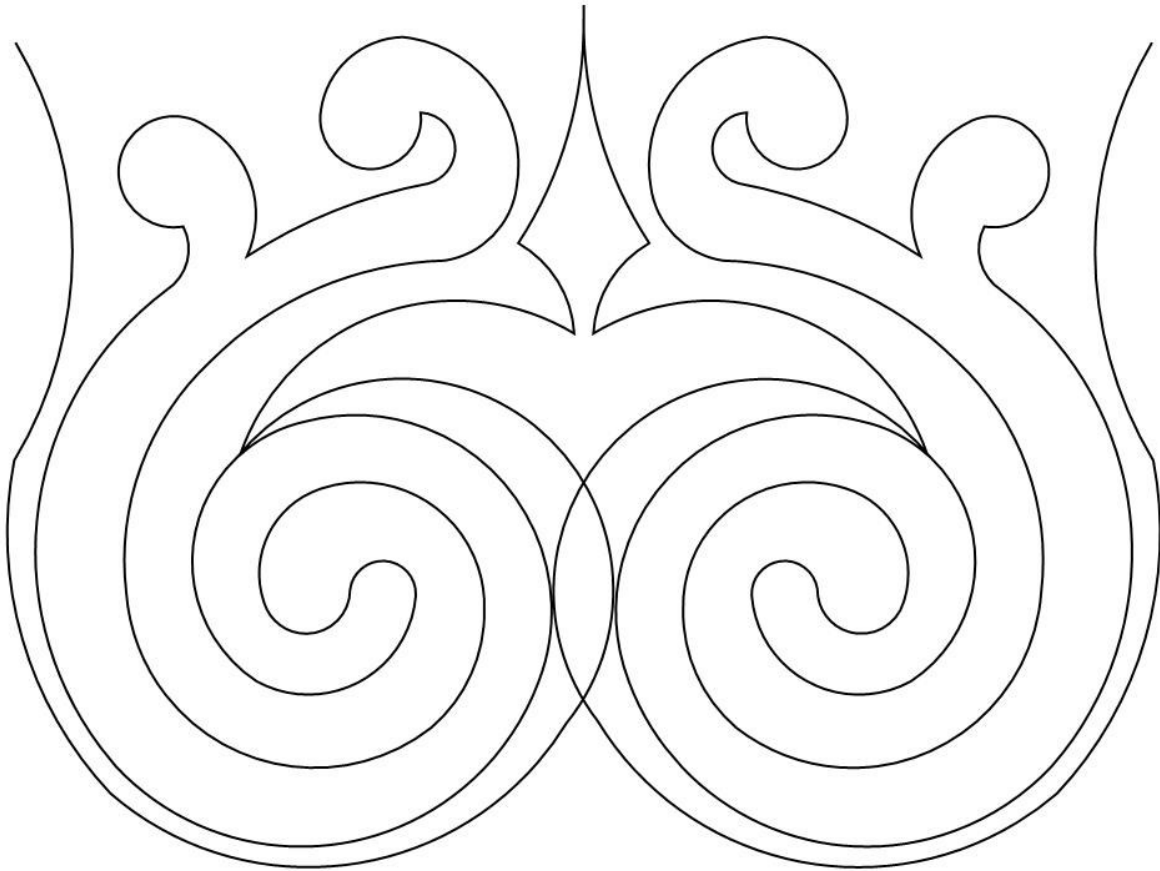

Pattern: chillings border 001

Archive: Onyx Earl

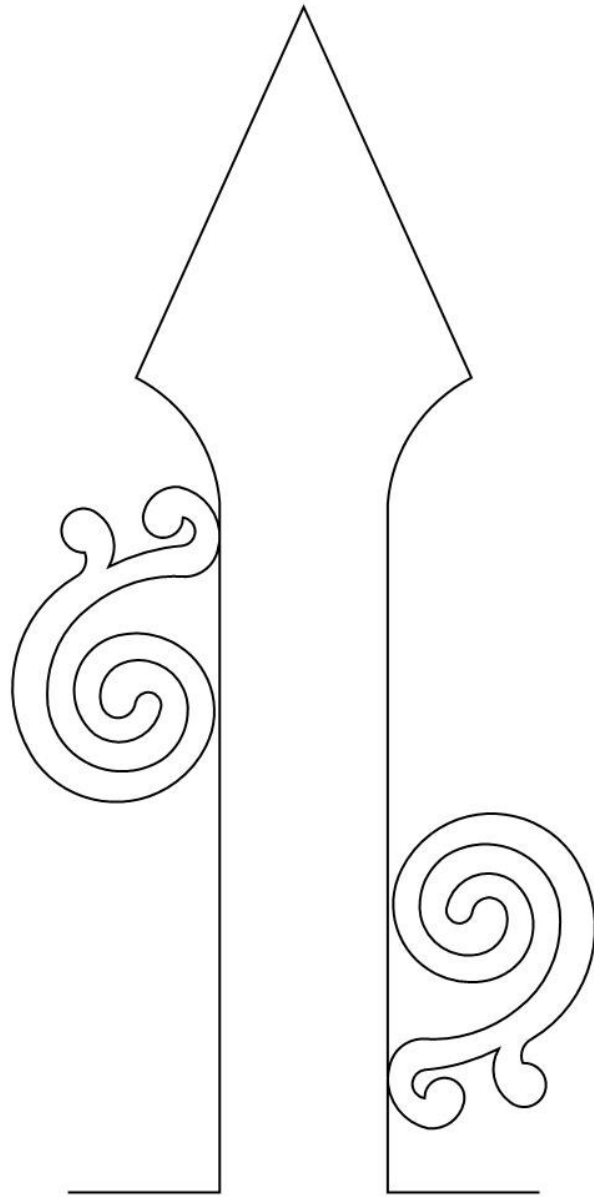

Pattern: chillings border 002

Archive: Onyx Earl

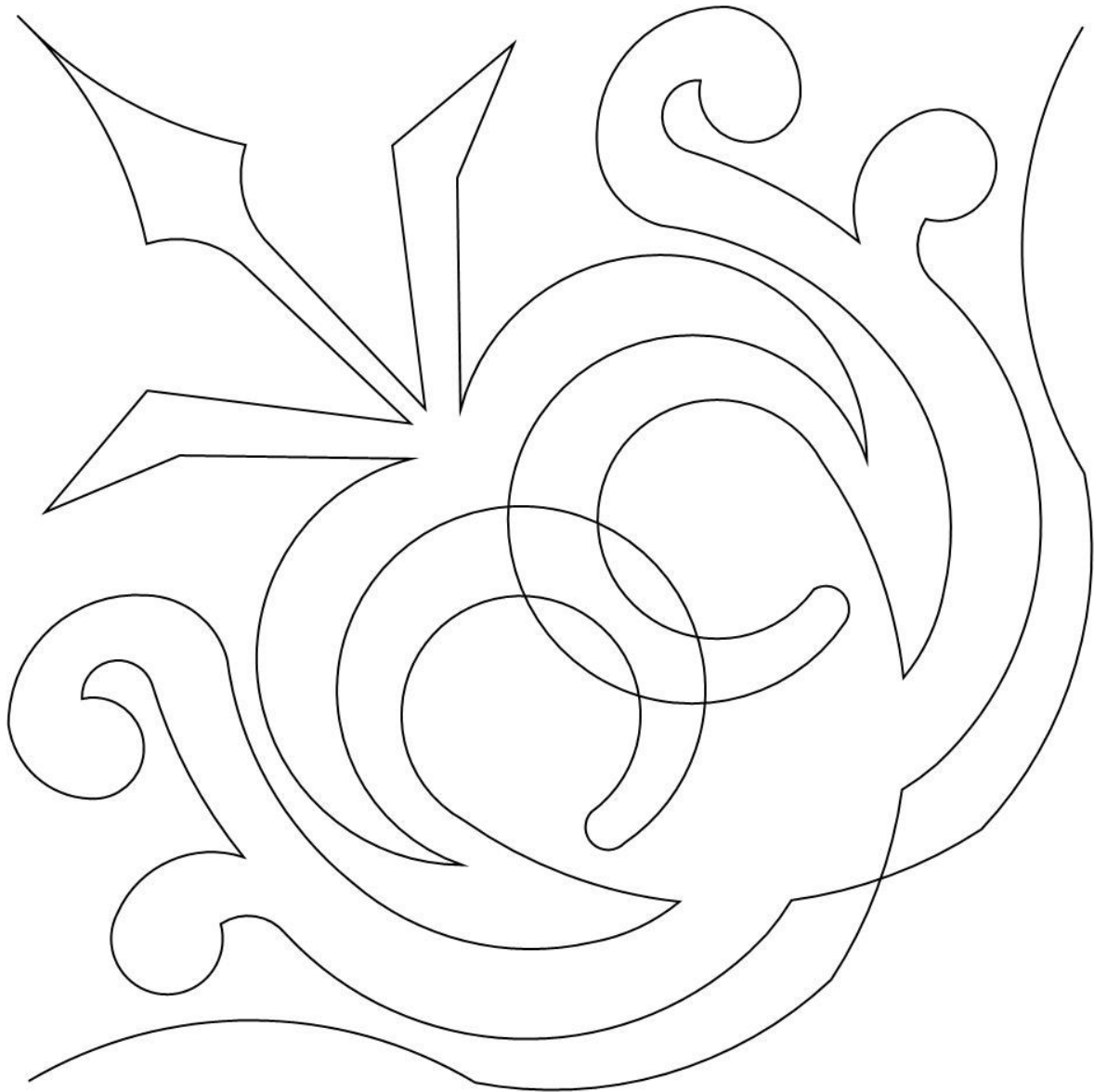

Pattern: chillings brd crn 001

Archive: Onyx Earl

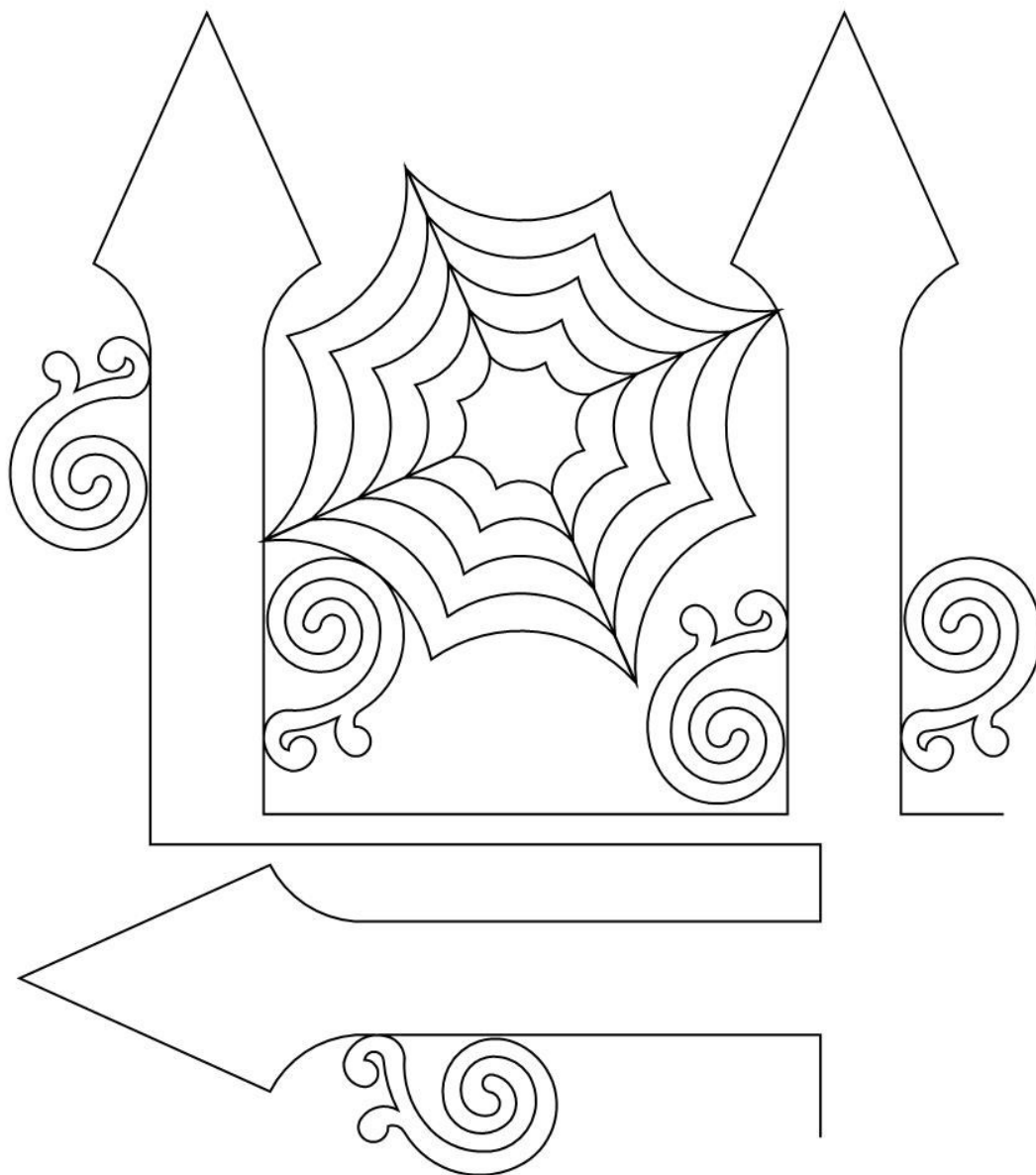

Pattern: chillings brd crn 002

Archive: Onyx Earl

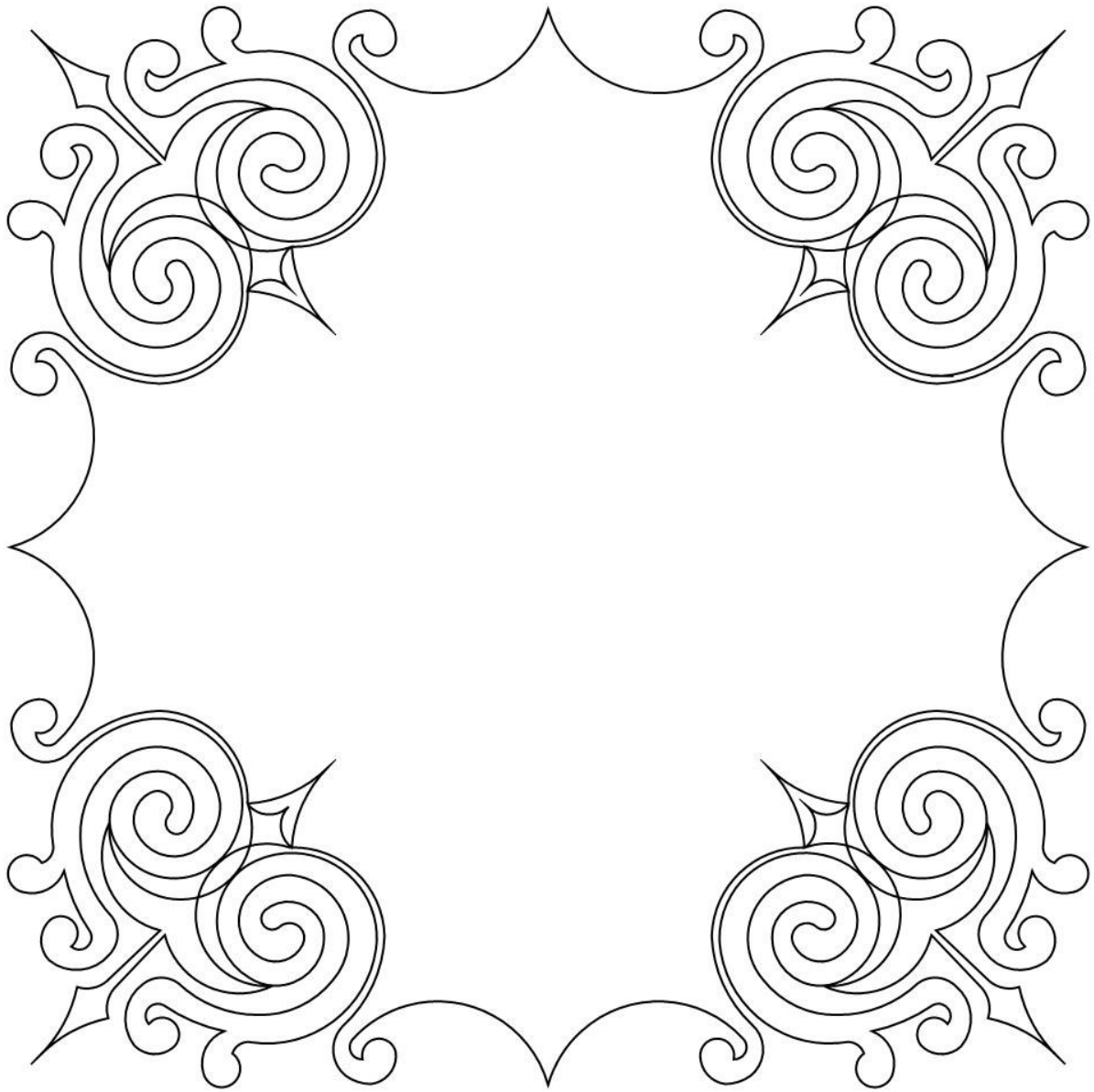

Pattern: chillings frame 001

Archive: Onyx Earl

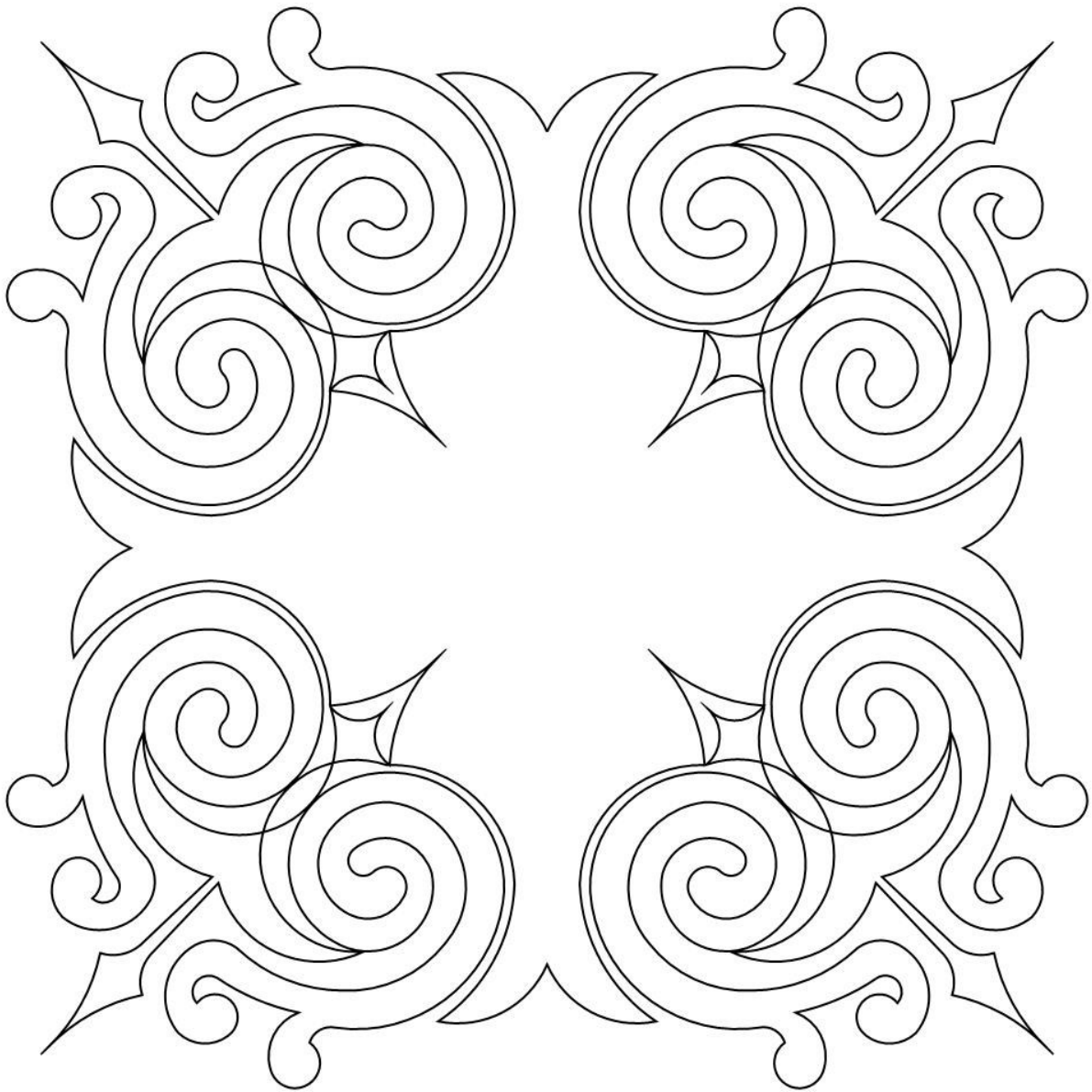

Pattern: chillings frame 002

Archive: Onyx Earl

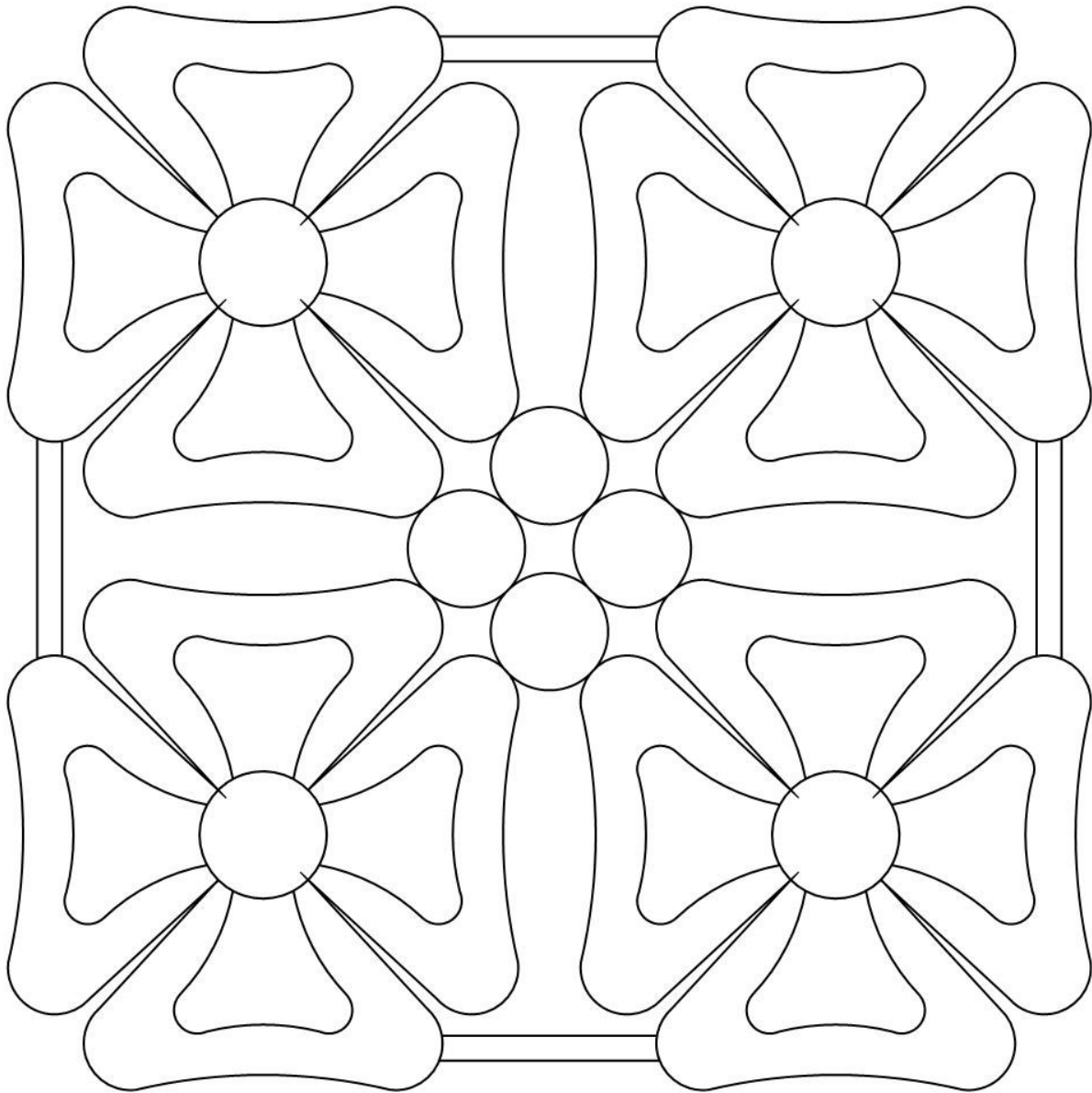

Pattern: cindy block 001

Archive: Onyx Earl

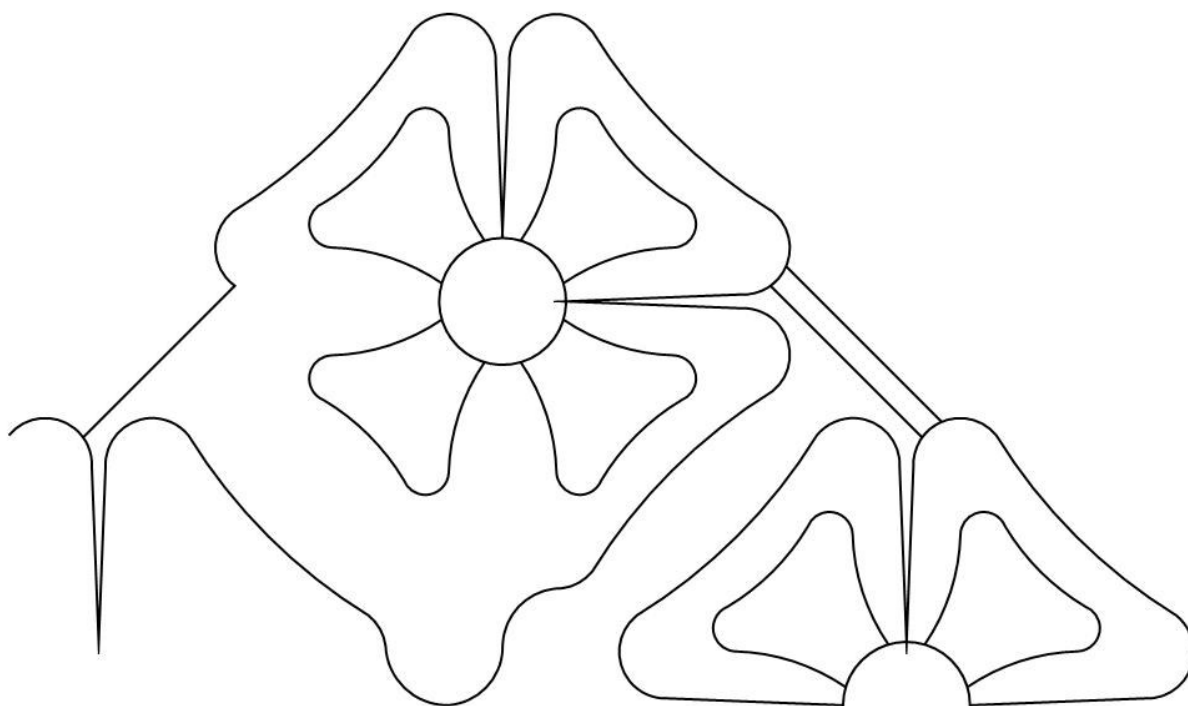

Pattern: cindy block 001 half

Archive: Onyx Earl

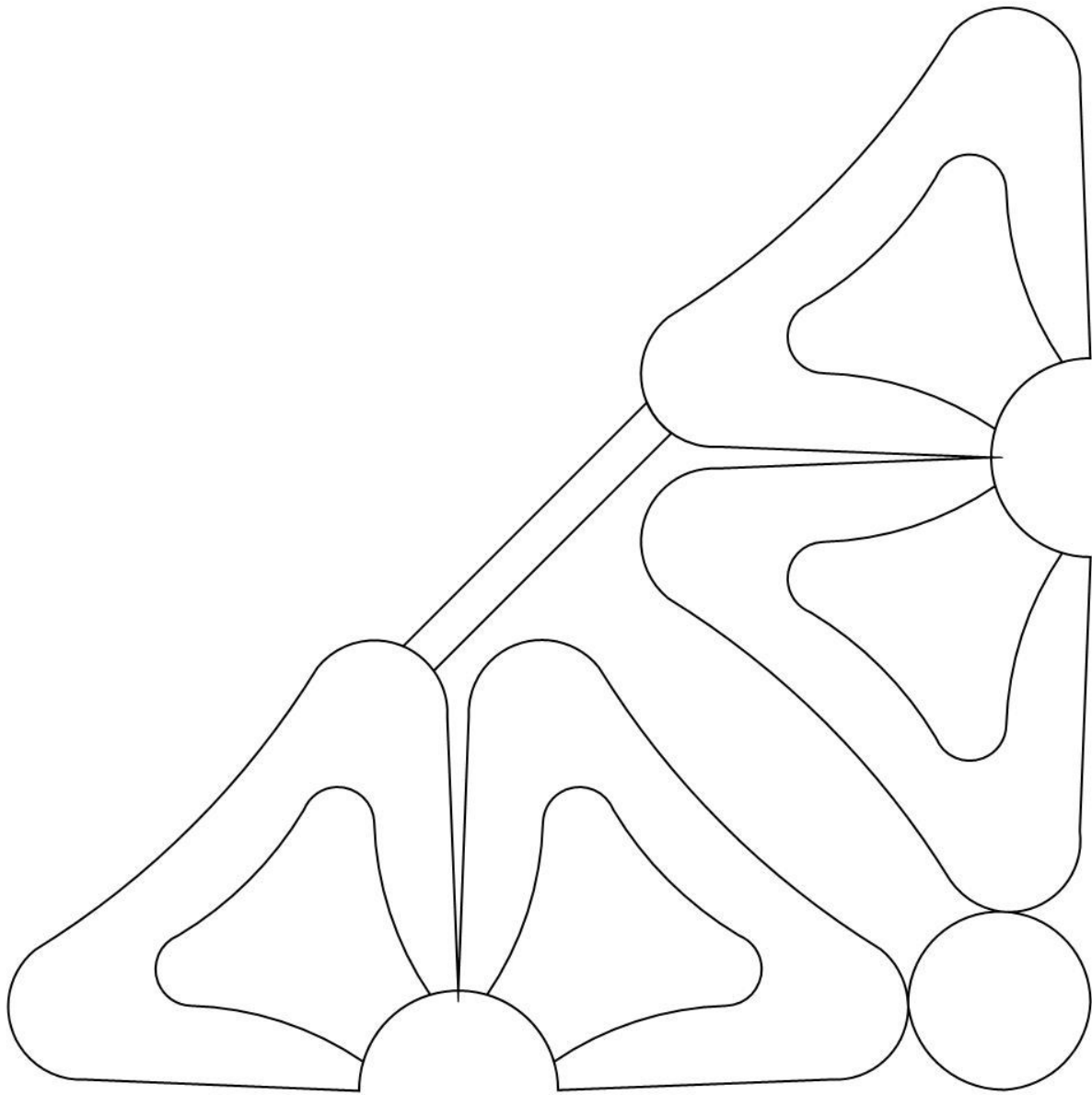

Pattern: cindy block 001 qtr

Archive: Onyx Earl

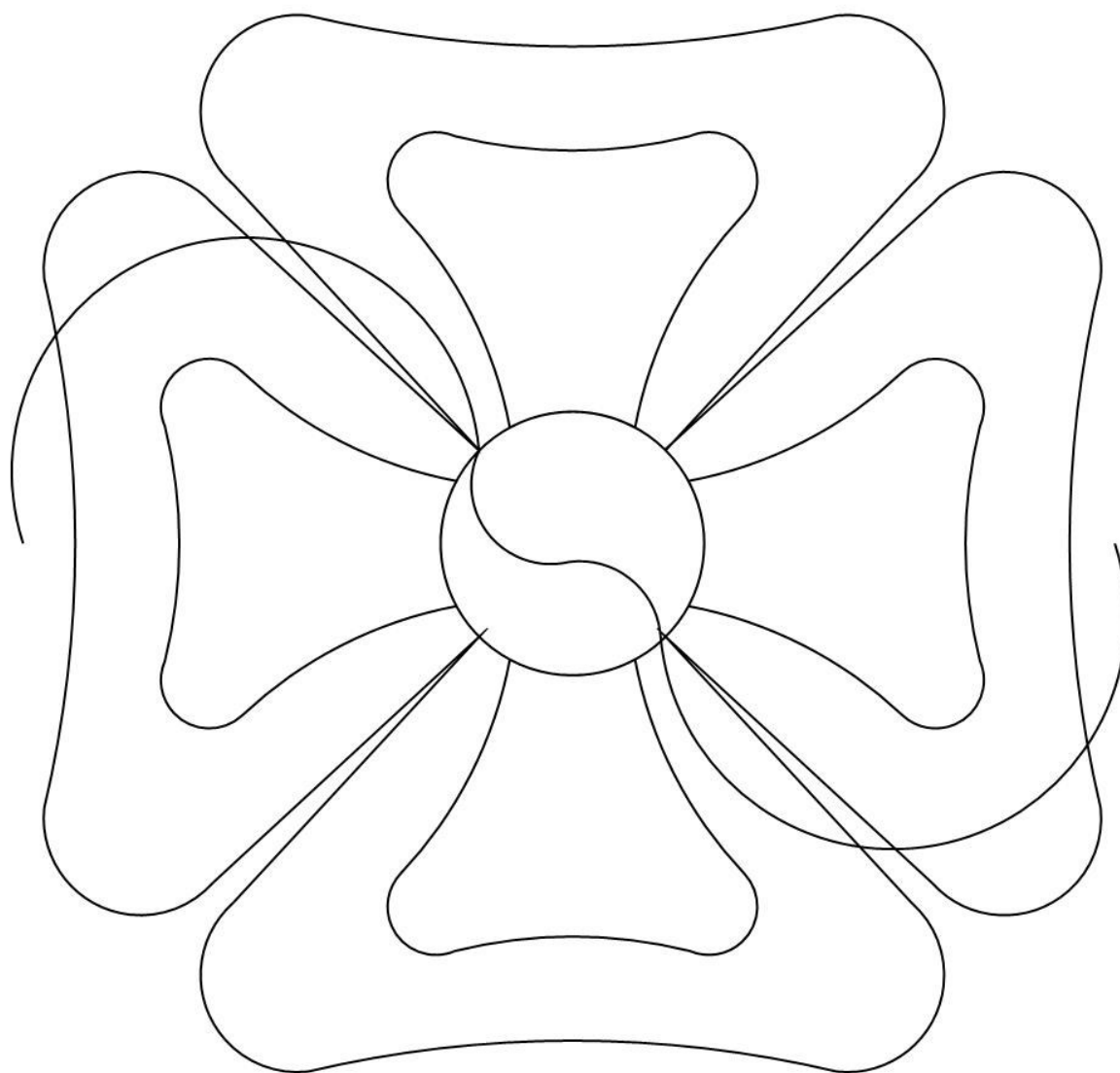

Pattern: cindy border 001

Archive: Onyx Earl

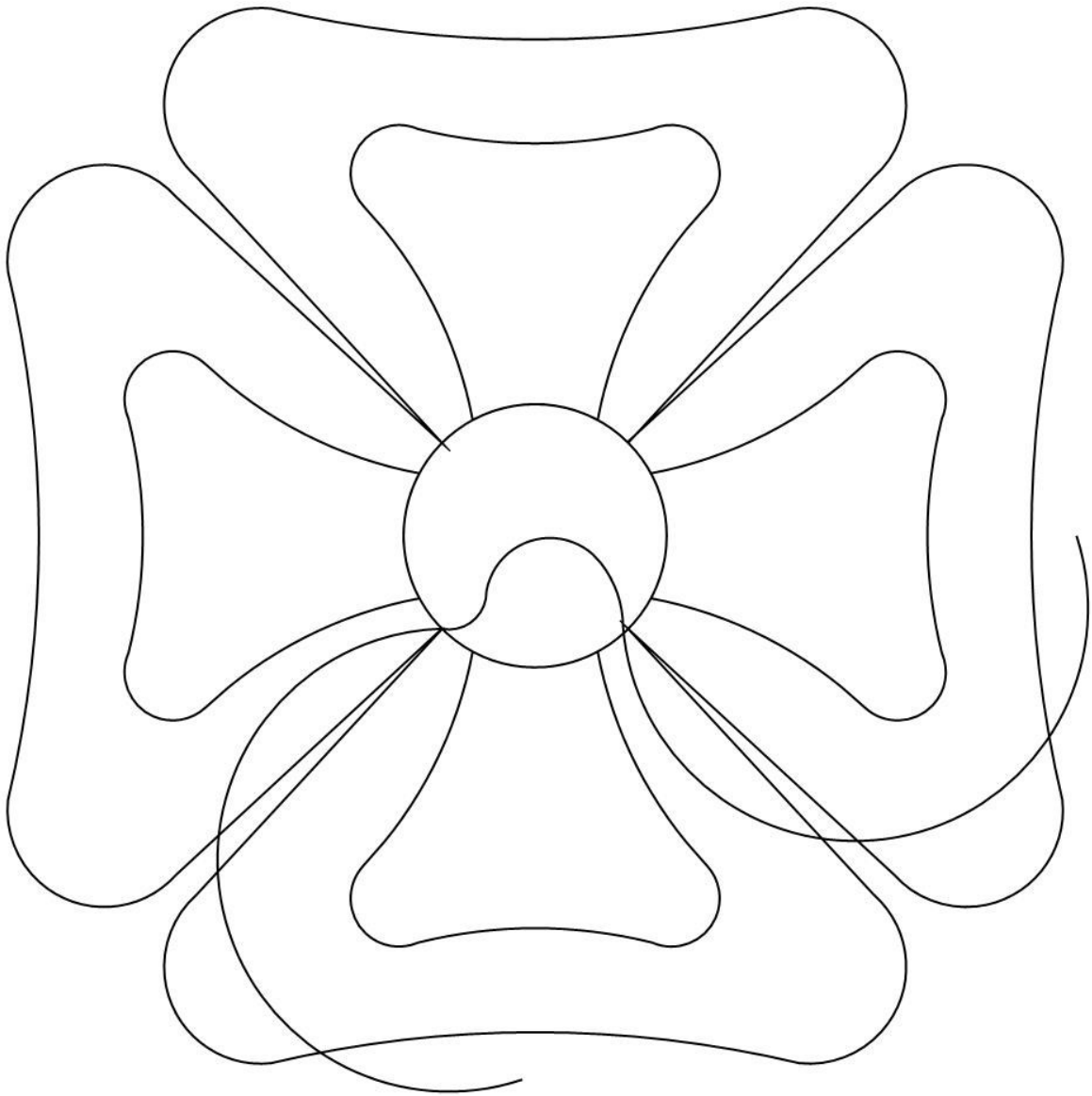

Pattern: cindy border corner 001

Archive: Onyx Earl

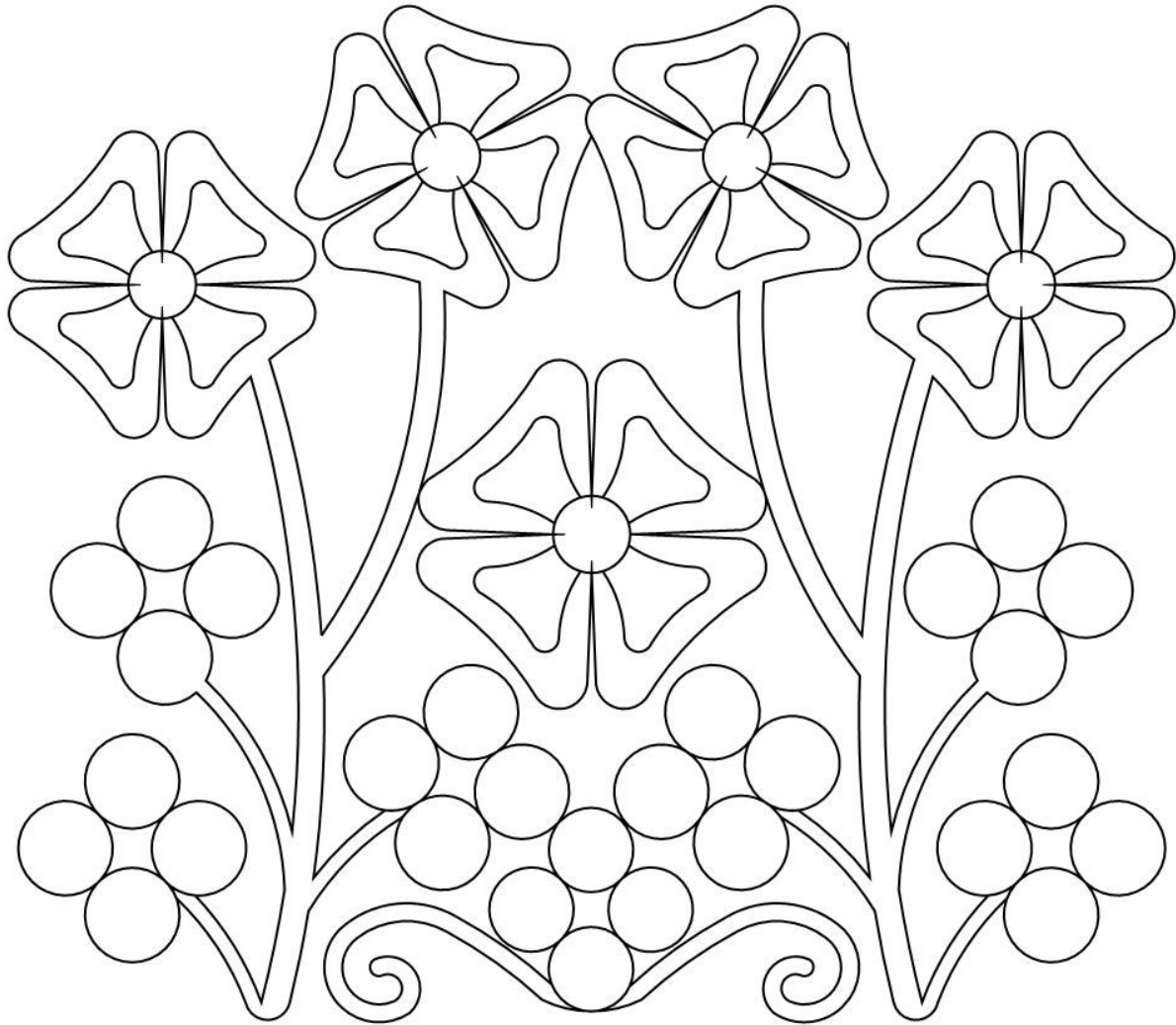

Pattern: cindy element 001

Archive: Onyx Earl

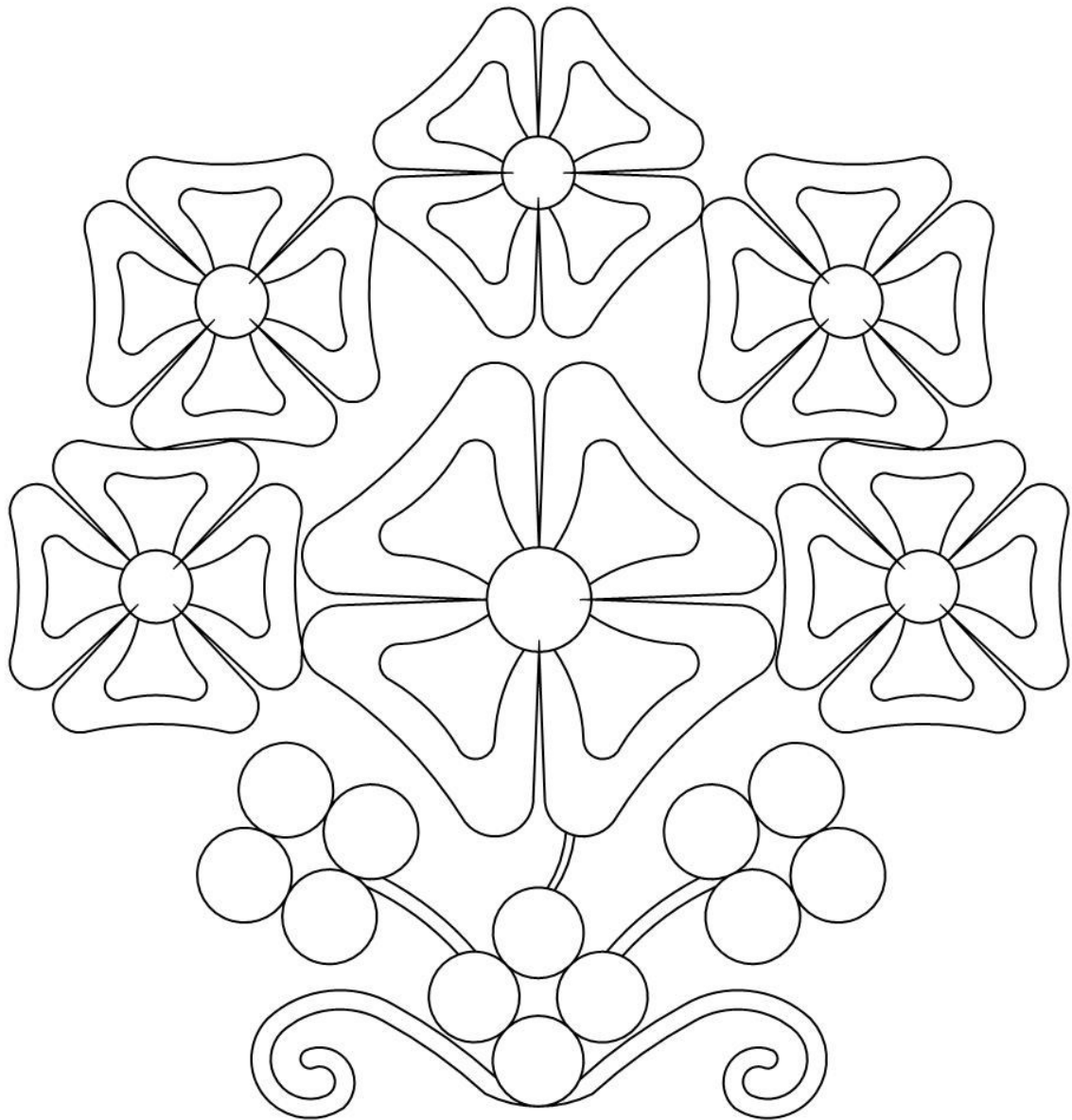

Pattern: cindy element 002

Archive: Onyx Earl

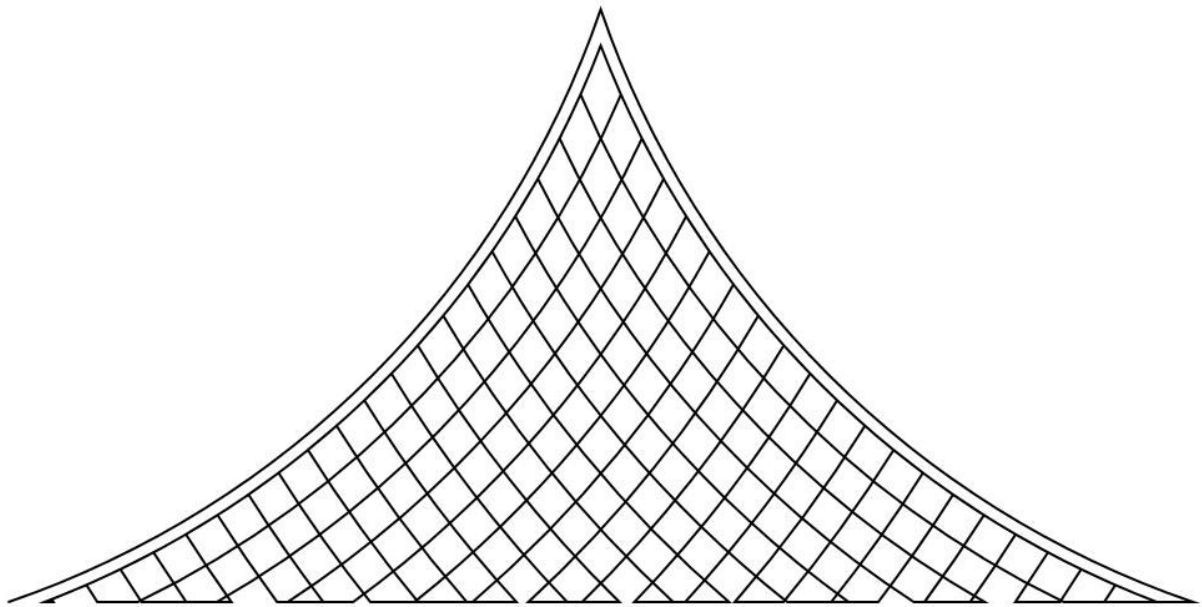

Pattern: curved triangle 001

Archive: Onyx Earl

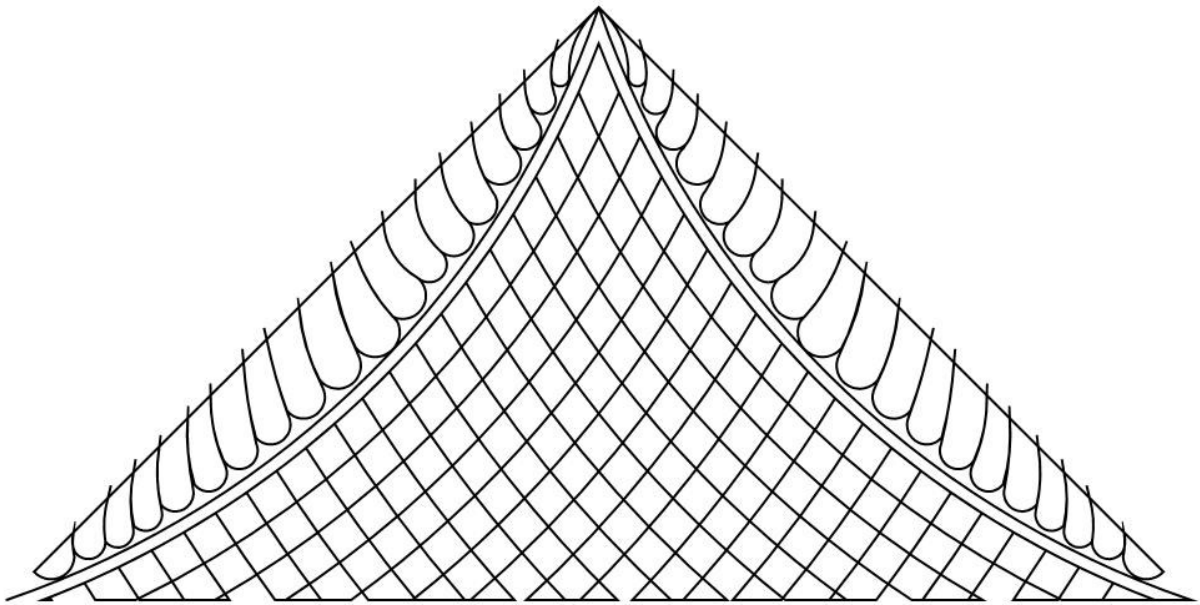

Pattern: curved triangle 002

Archive: Onyx Earl

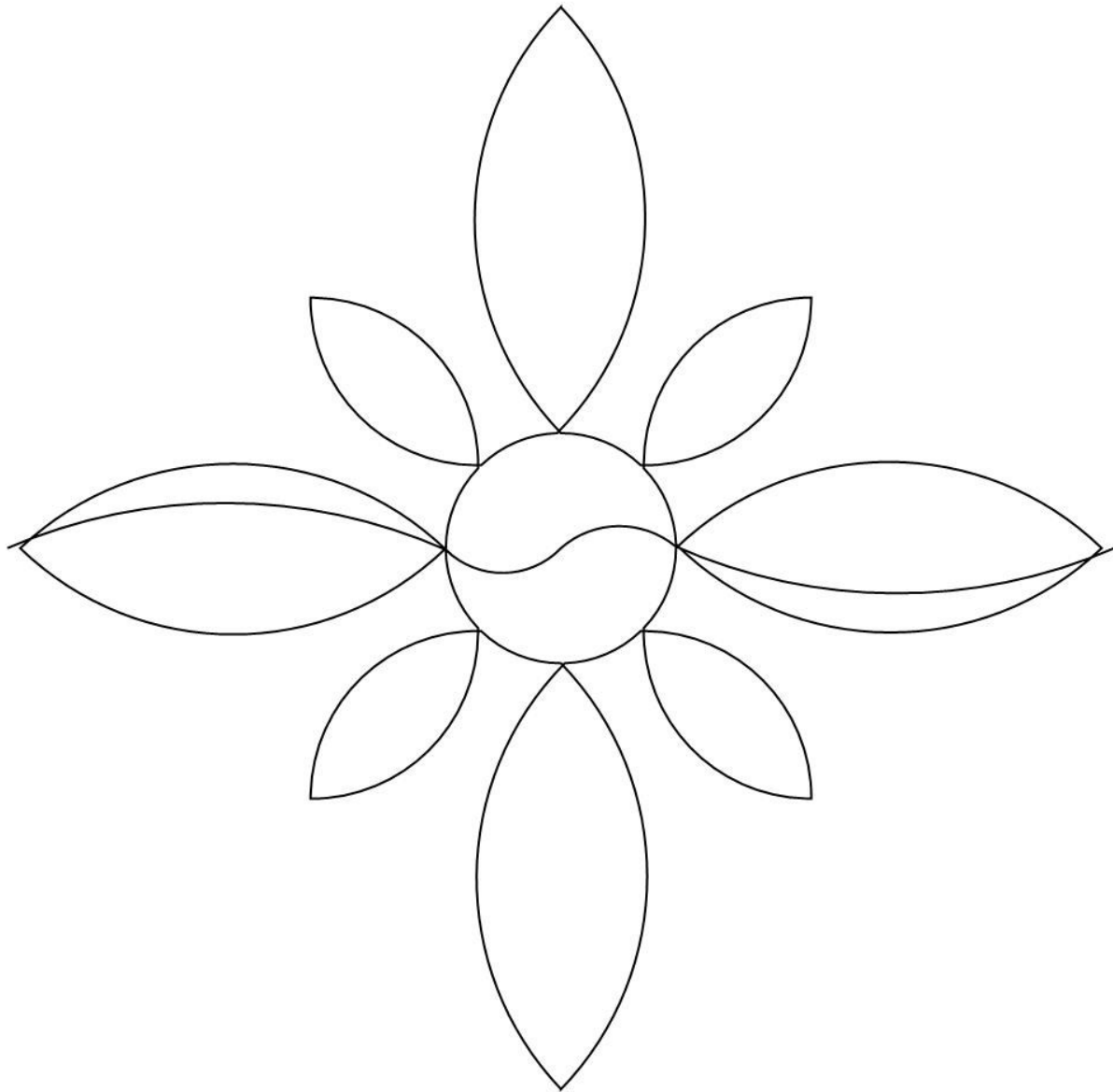

Pattern: dawns p2p 004 sq

Archive: Onyx Earl

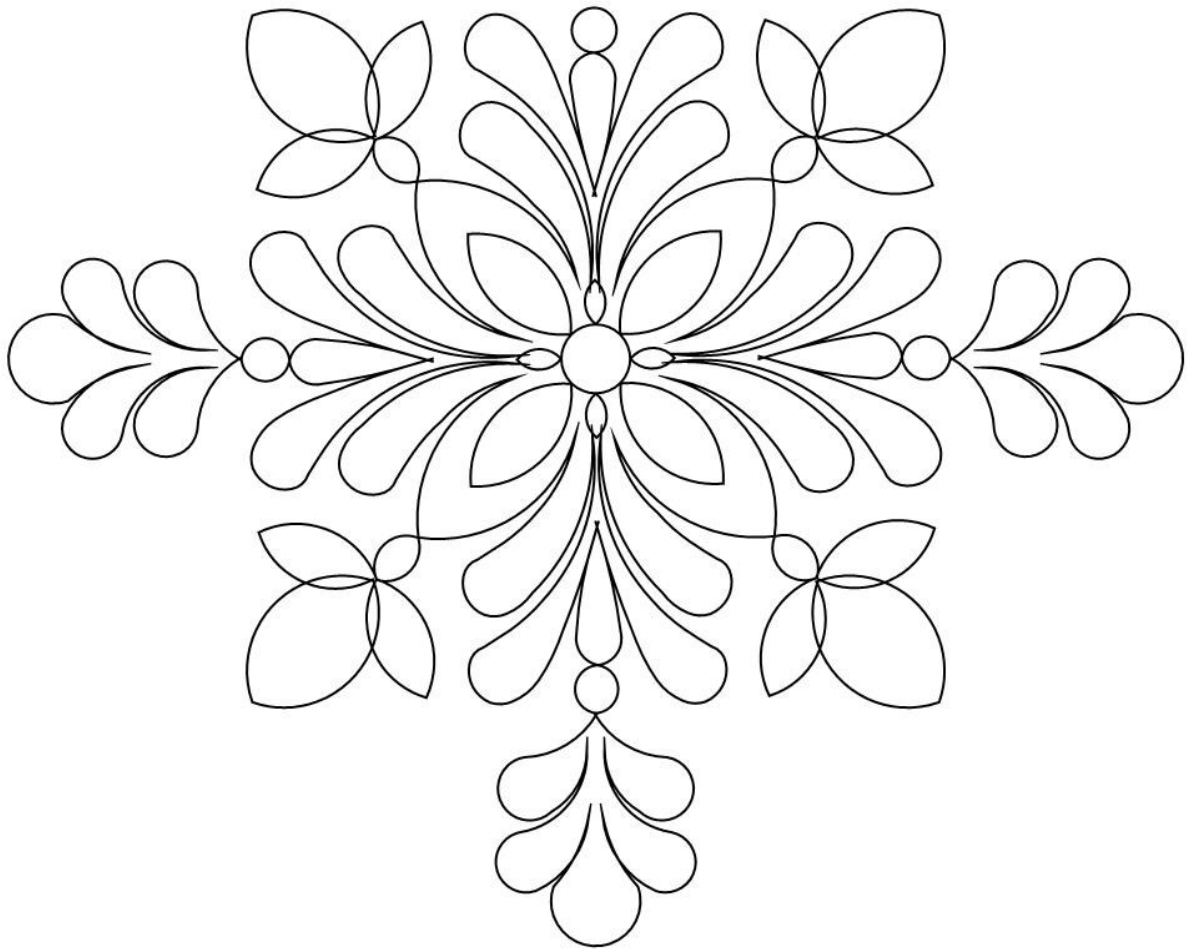

Pattern: dawns sic 001 a

Archive: Onyx Earl

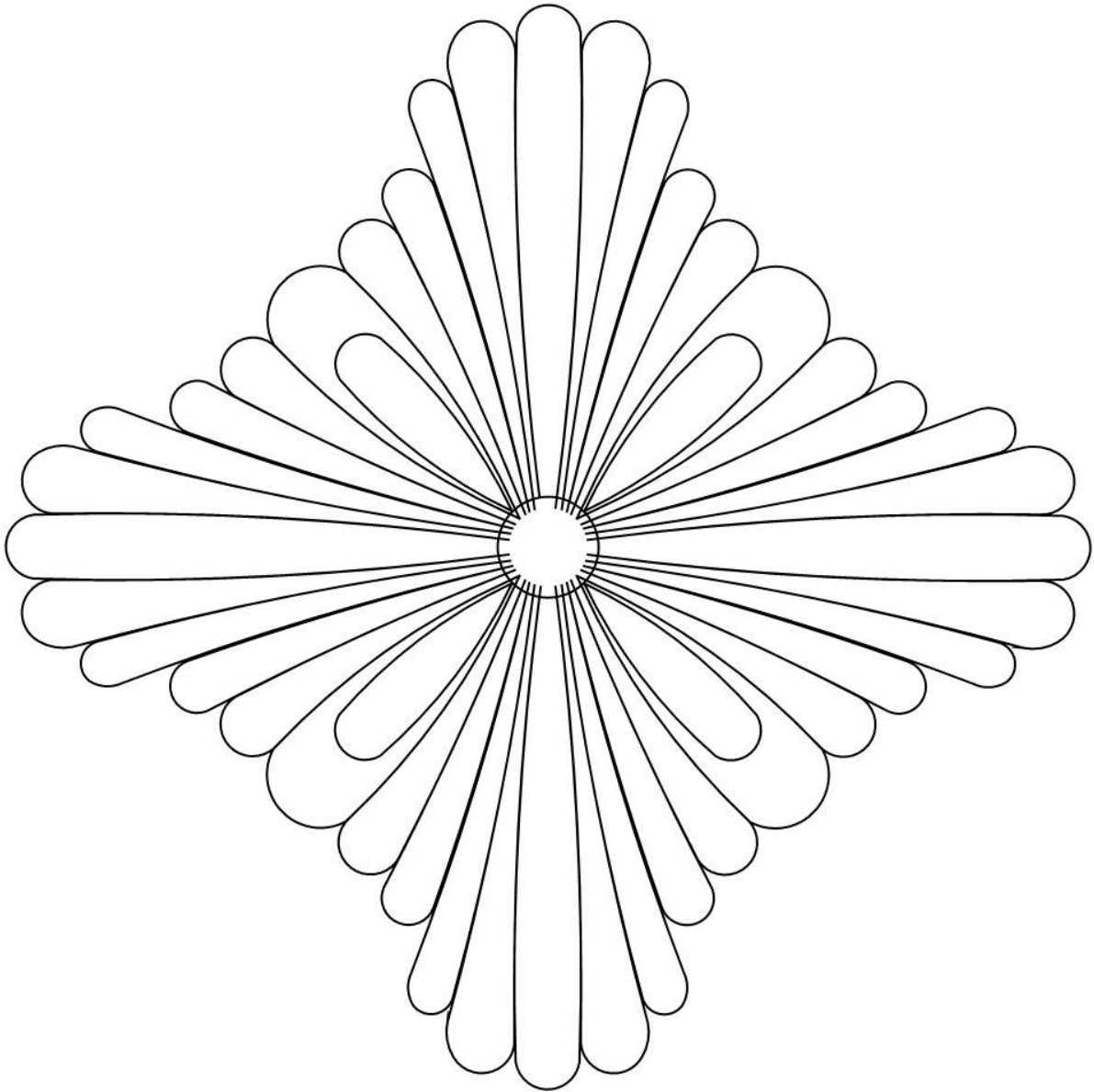

Pattern: dixie feather 001

Archive: Onyx Earl

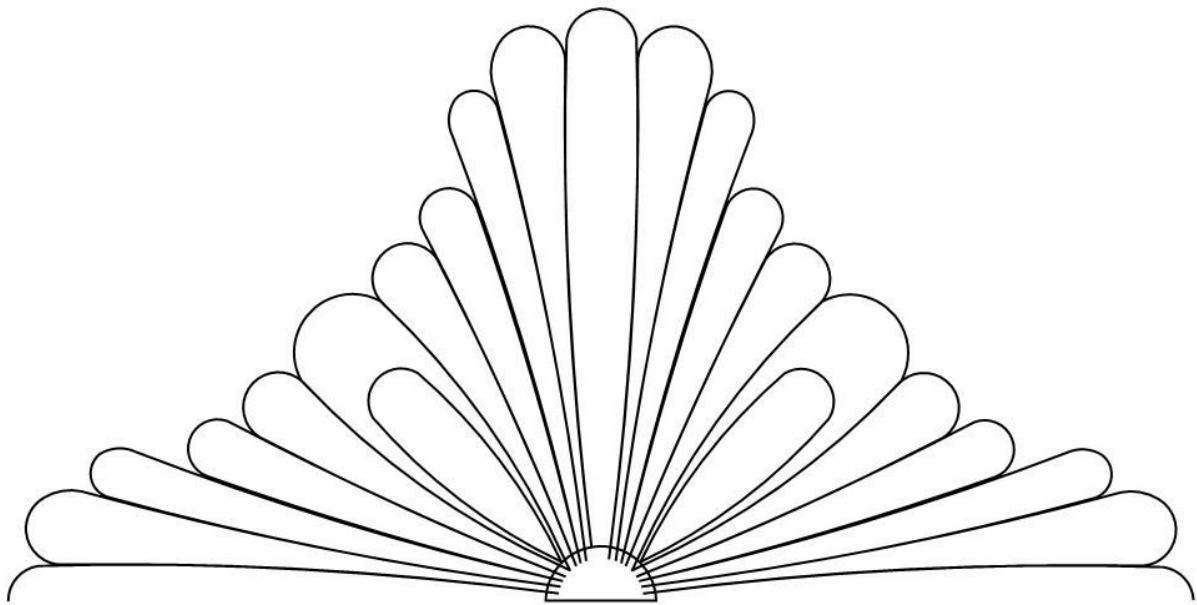

Pattern: dixie feather 001 half

Archive: Onyx Earl

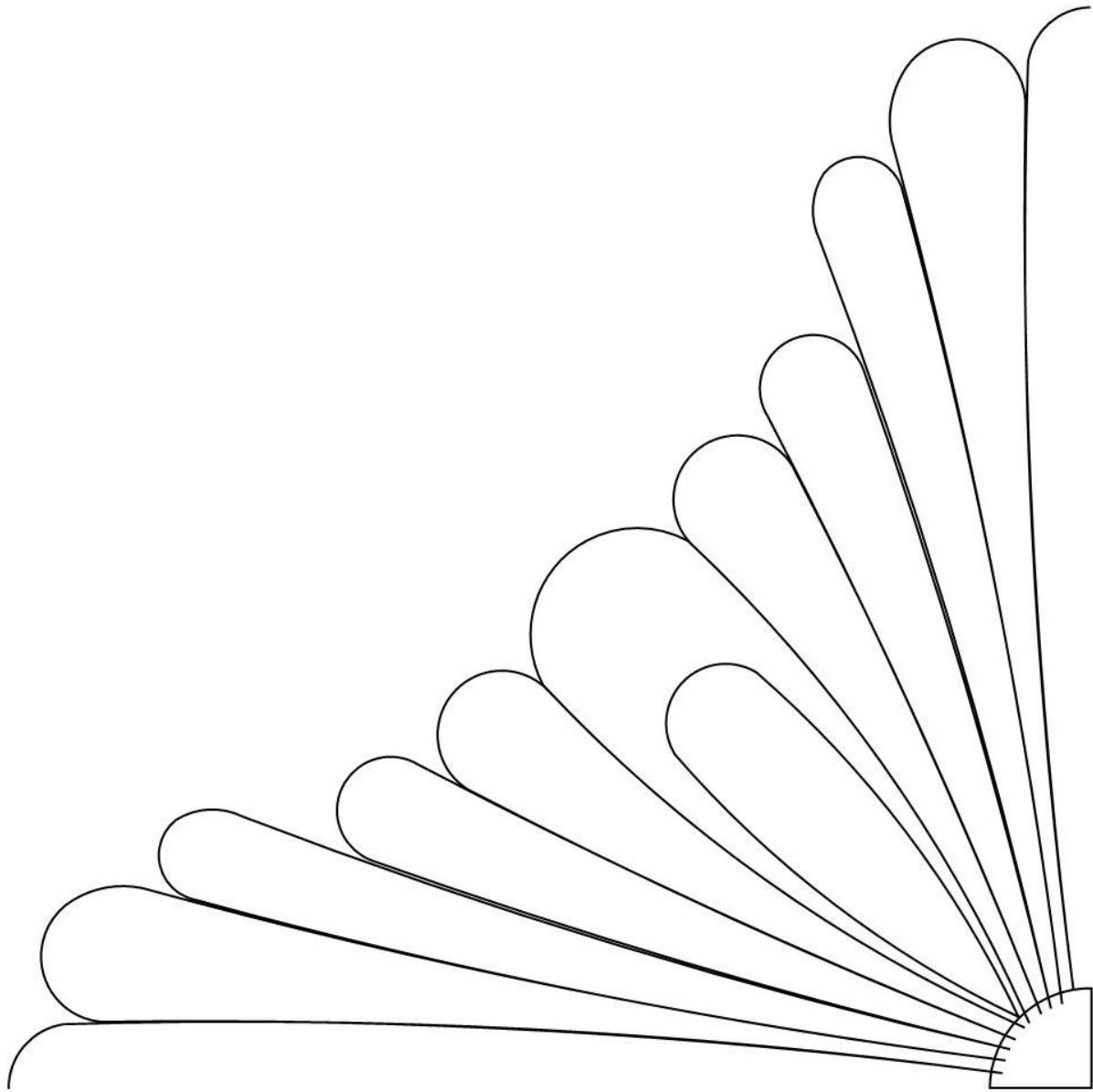

Pattern: dixie feather 001 qtr

Archive: Onyx Earl

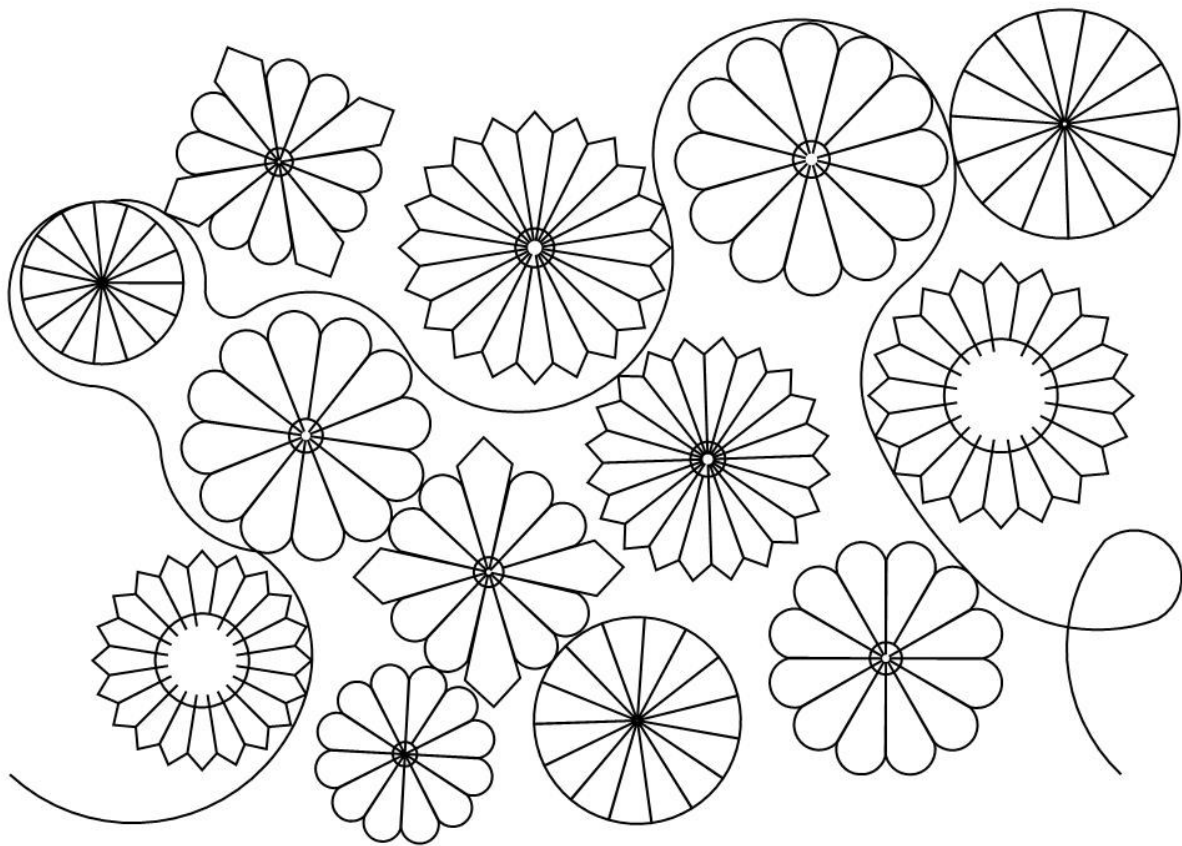

Pattern: dresdan pano 001

Archive: Onyx Earl

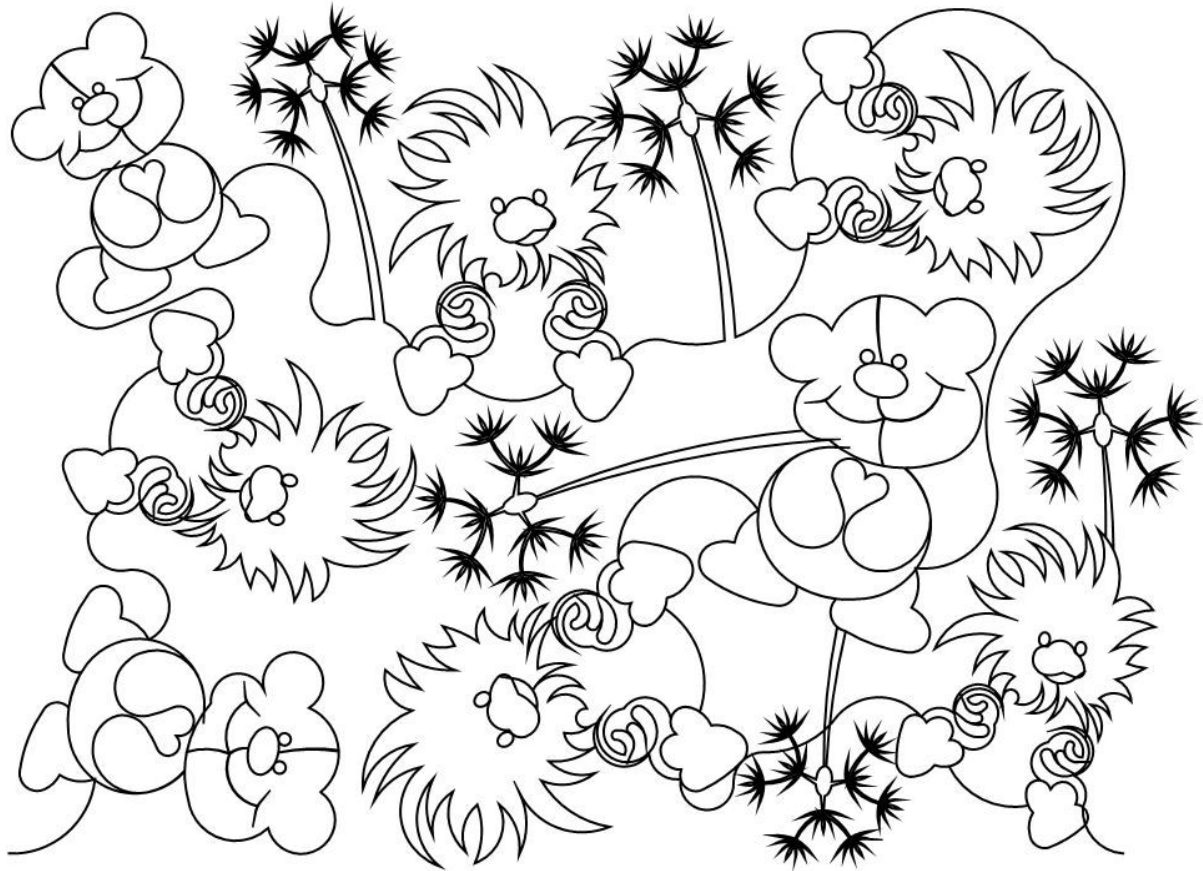

Pattern: ducky dandy pano 001

Archive: Onyx Earl

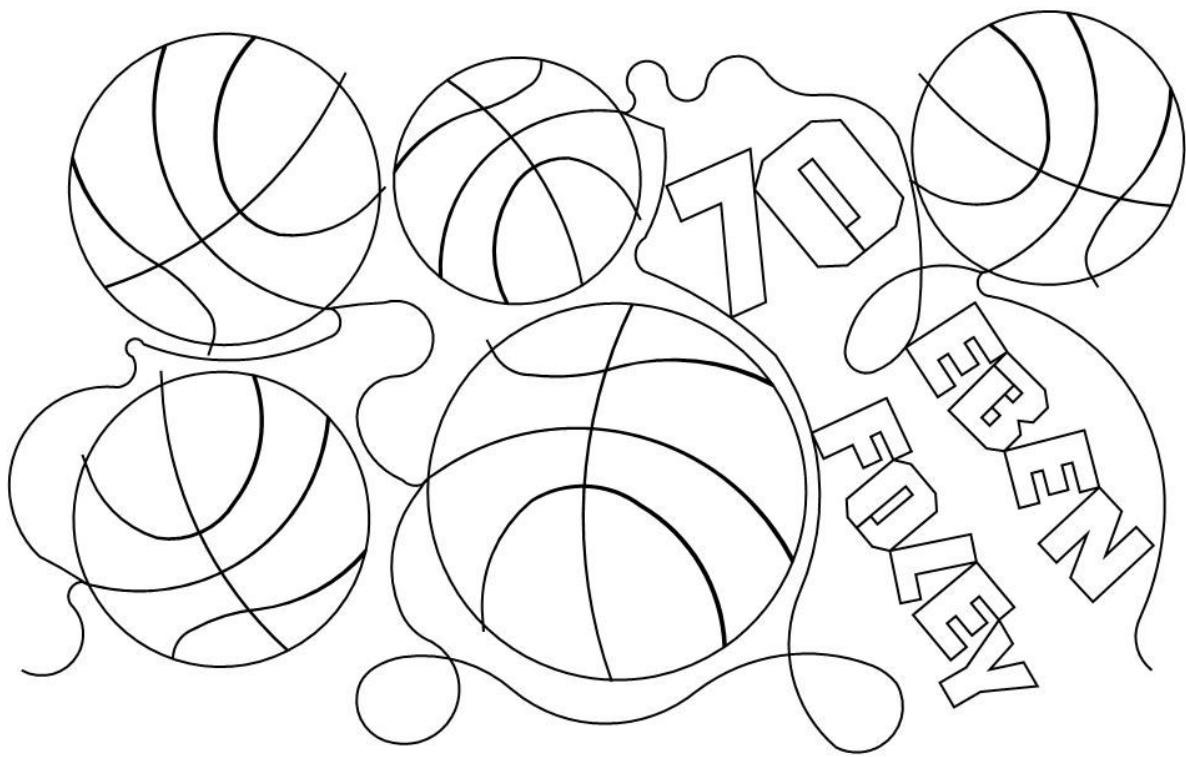

Pattern: eben pano 001

Archive: Onyx Earl

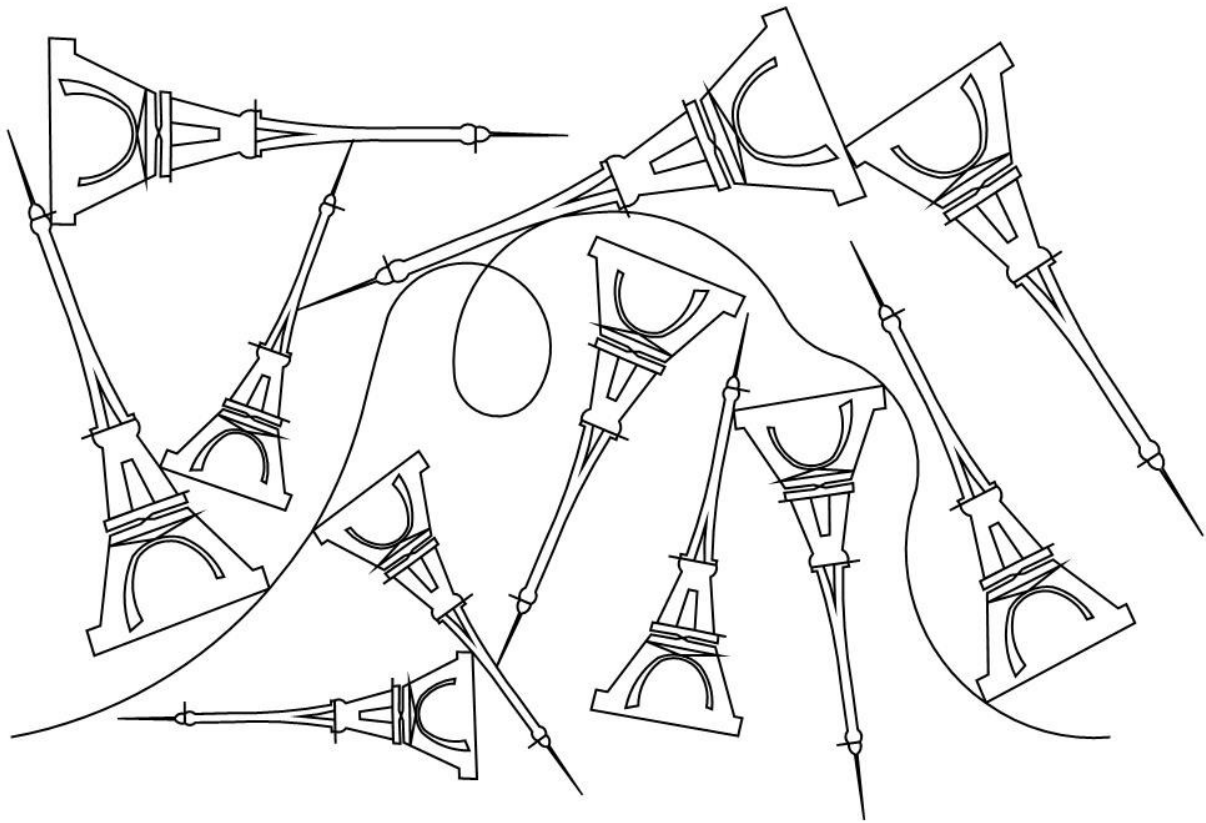

Pattern: eiffel tower pano 003

Archive: Onyx Earl

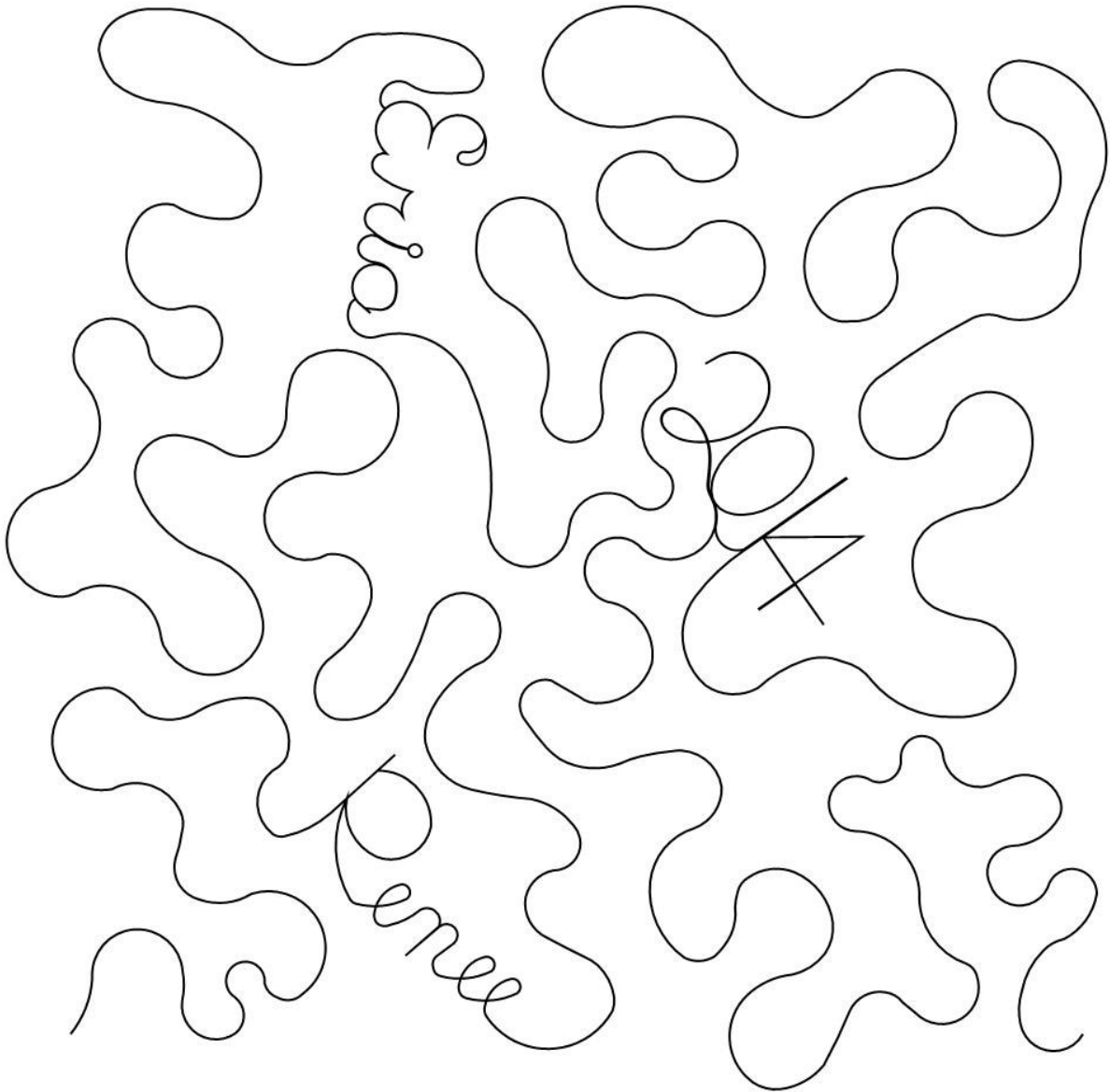

Pattern: eric renee meander

Archive: Onyx Earl

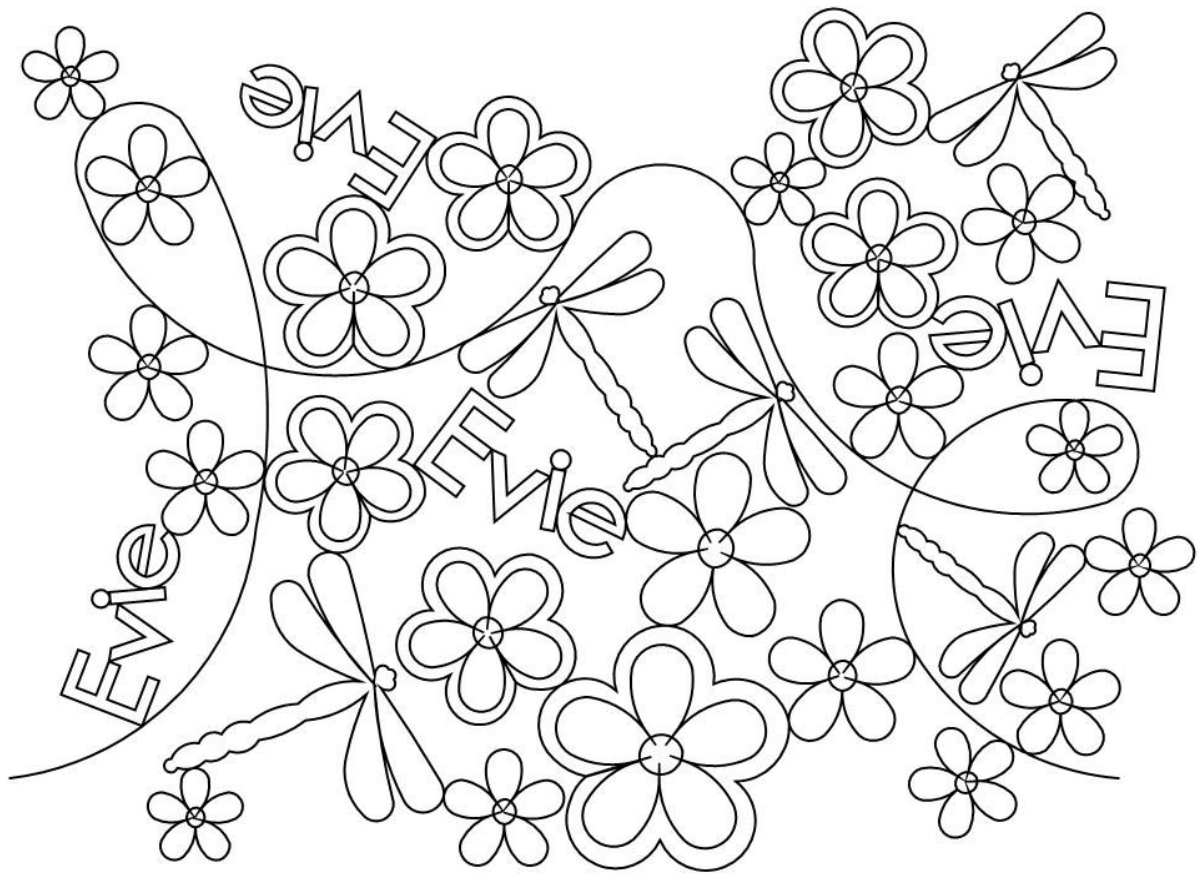

Pattern: evie pano 001

Archive: Onyx Earl



Pattern: fall welcome block 002

Archive: Onyx Earl

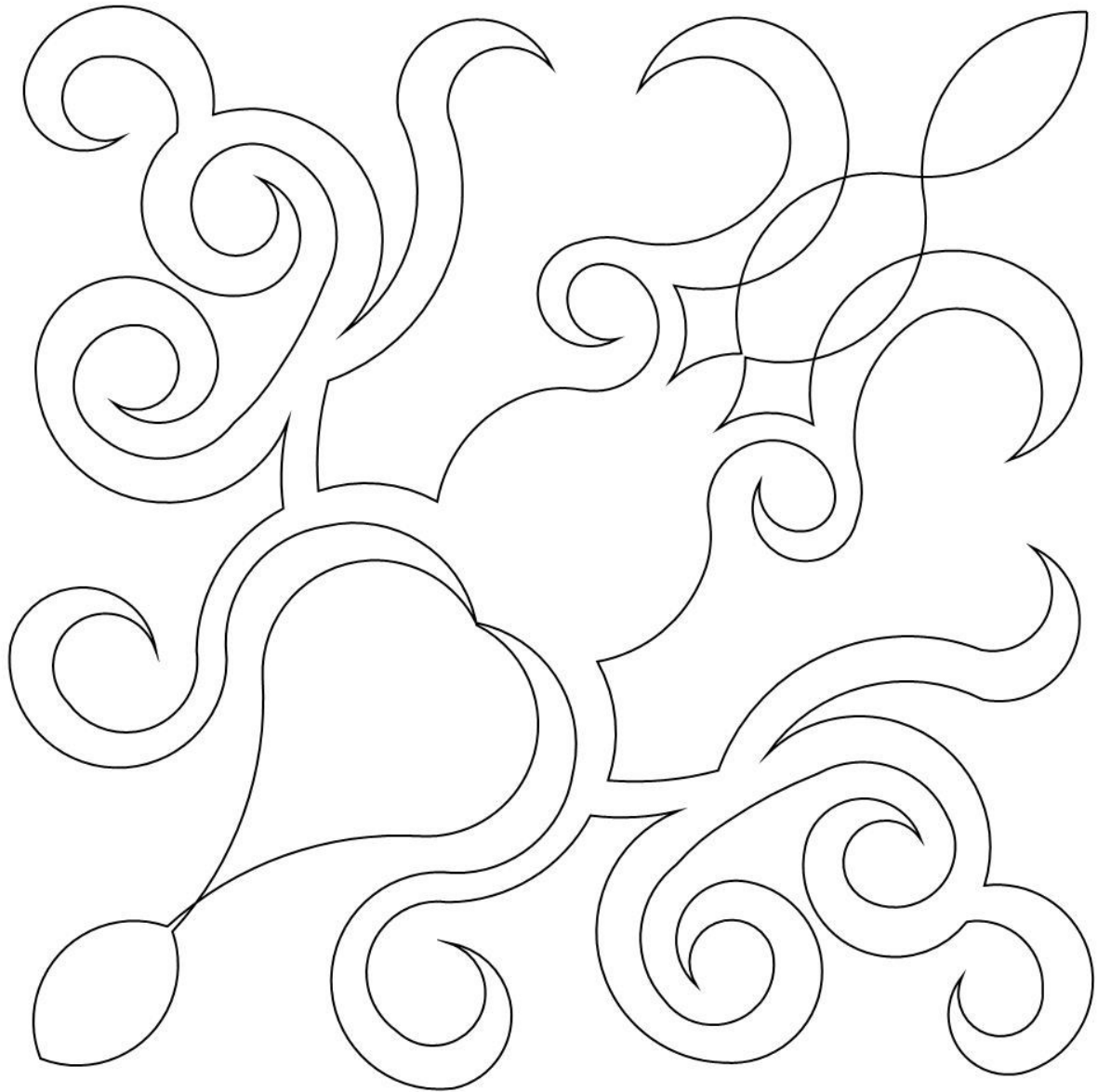

Pattern: feather diamond corner 001

Archive: Onyx Earl

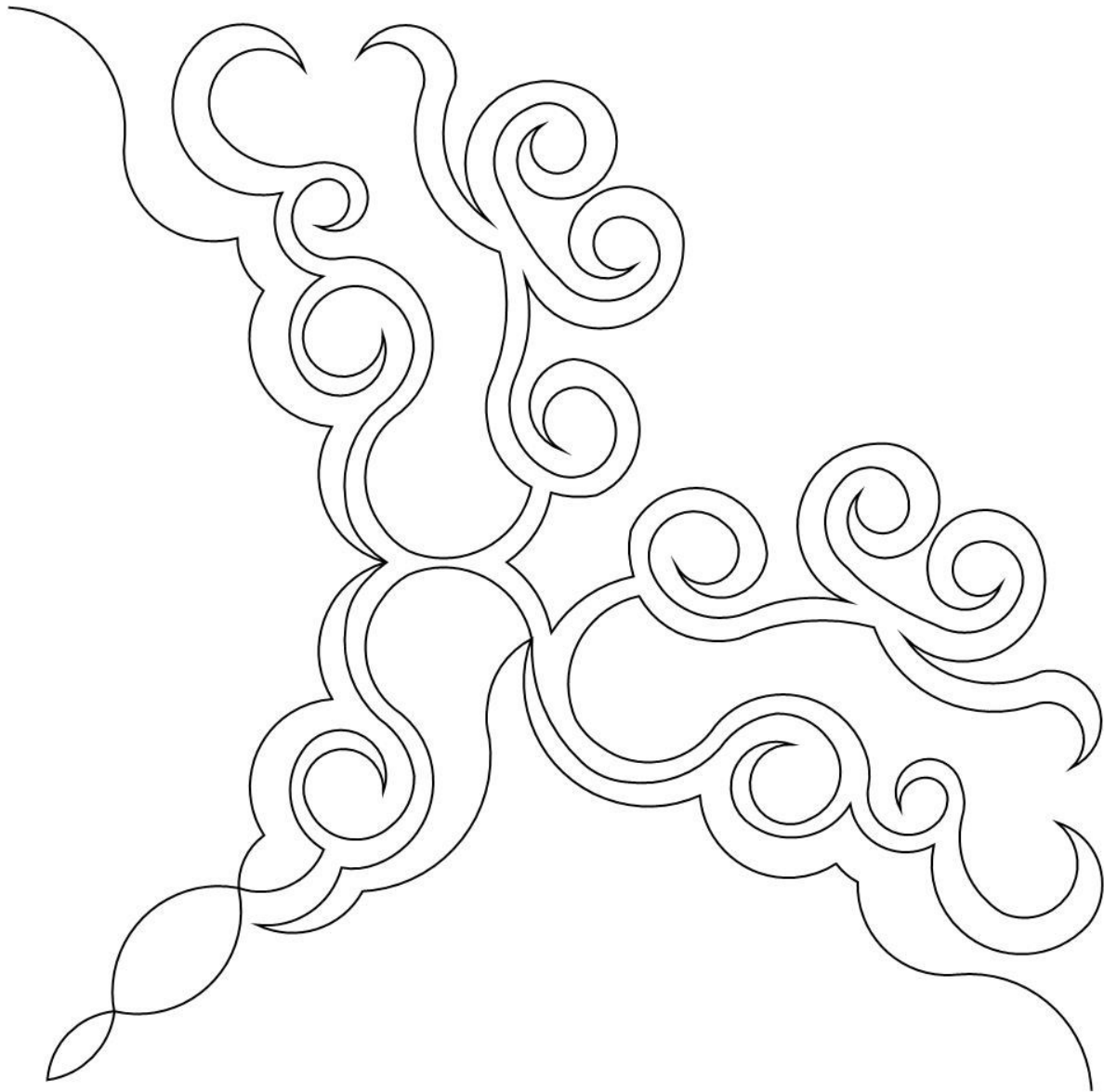

Pattern: feather diamond corner 002

Archive: Onyx Earl

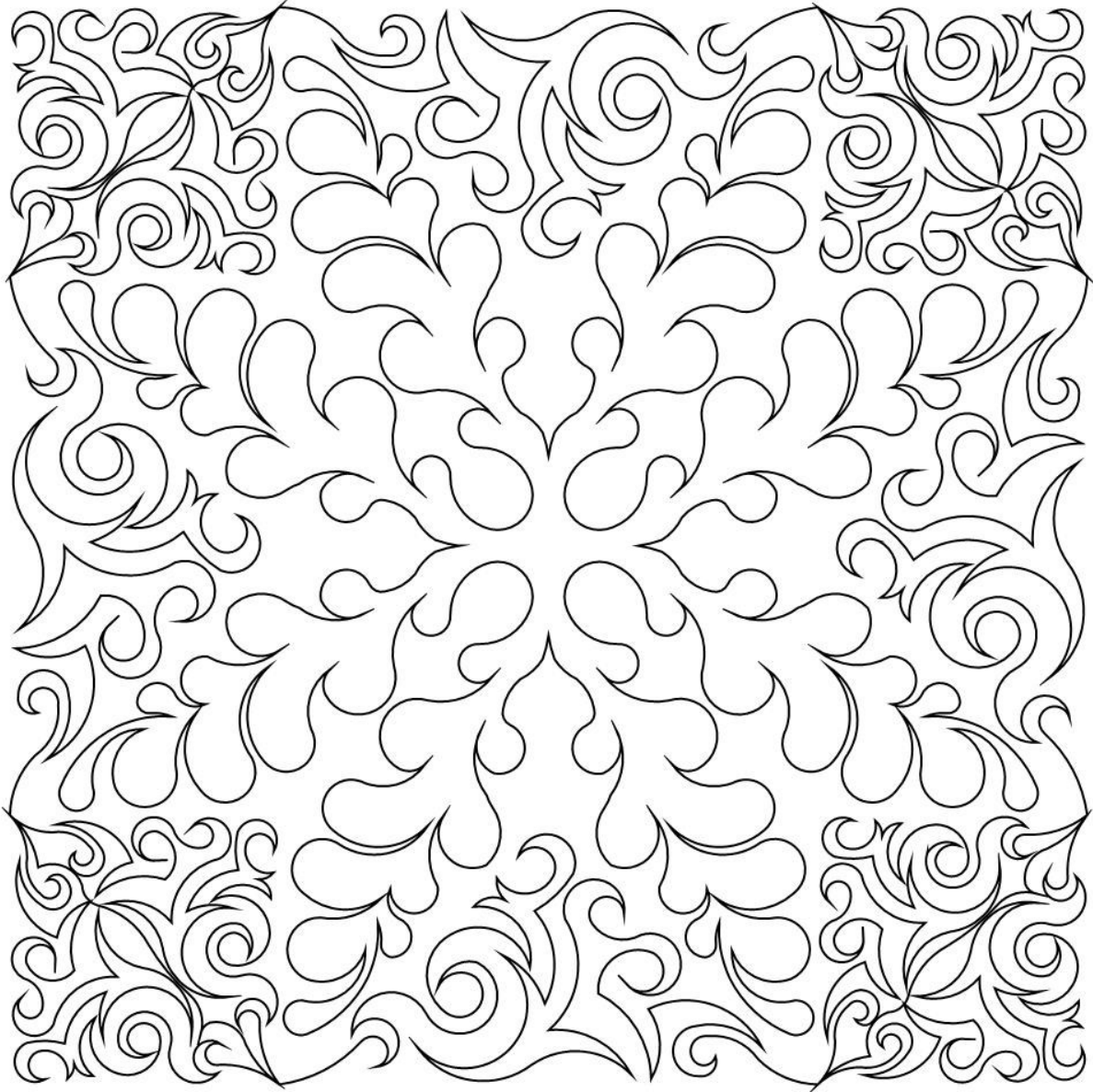

Pattern: feather star 006

Archive: Onyx Earl

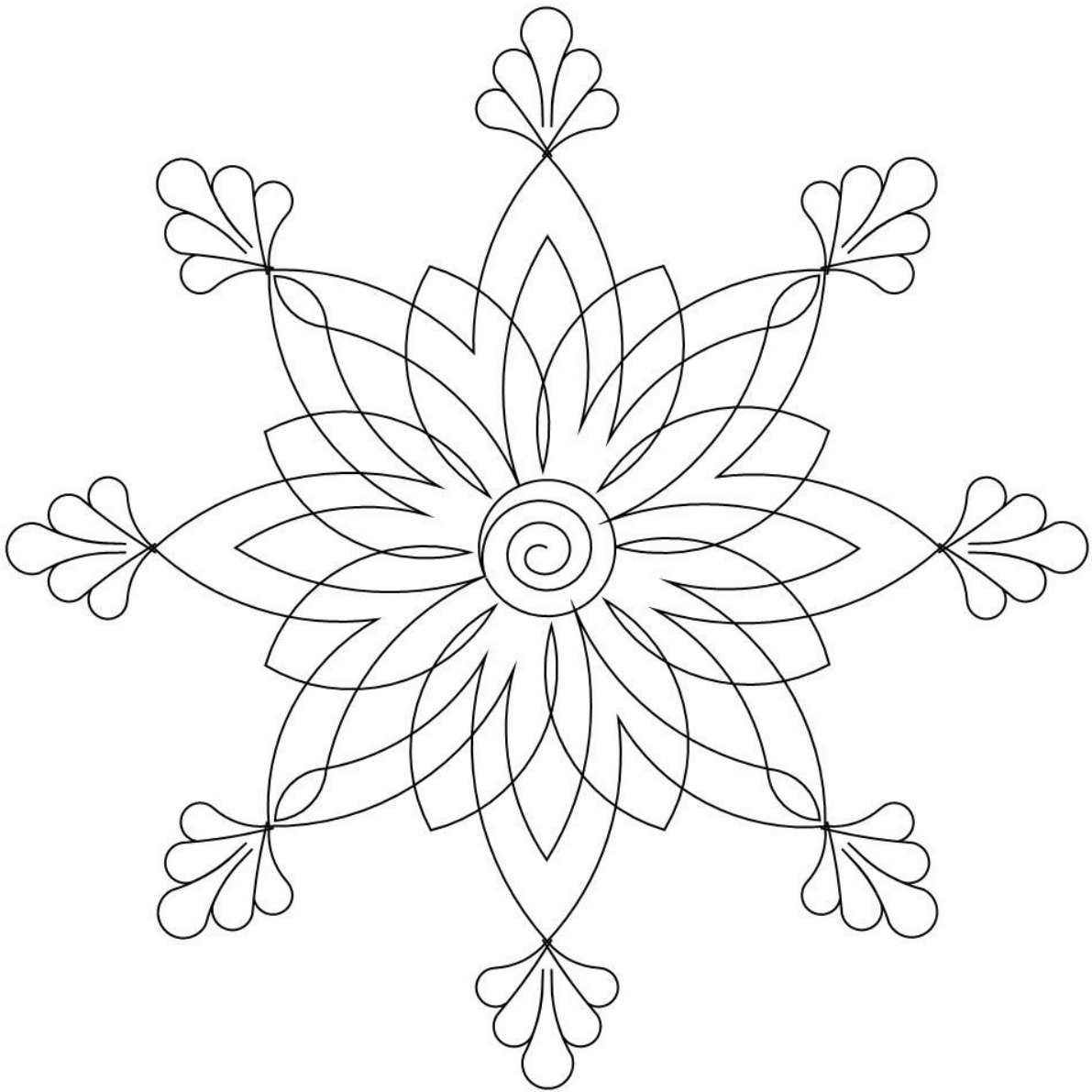

Pattern: feather star ctr 002

Archive: Onyx Earl

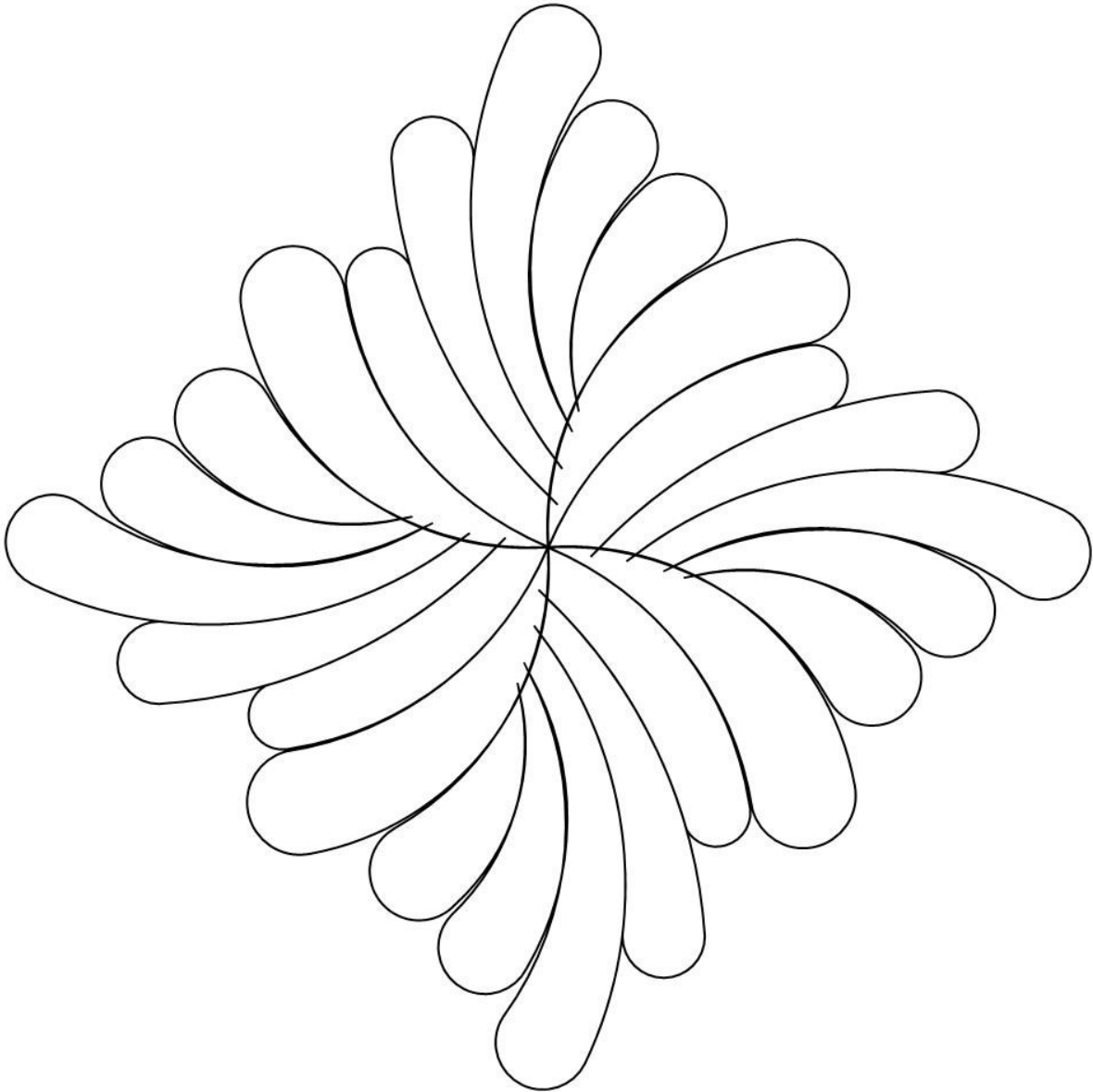

Pattern: feather tic 001

Archive: Onyx Earl

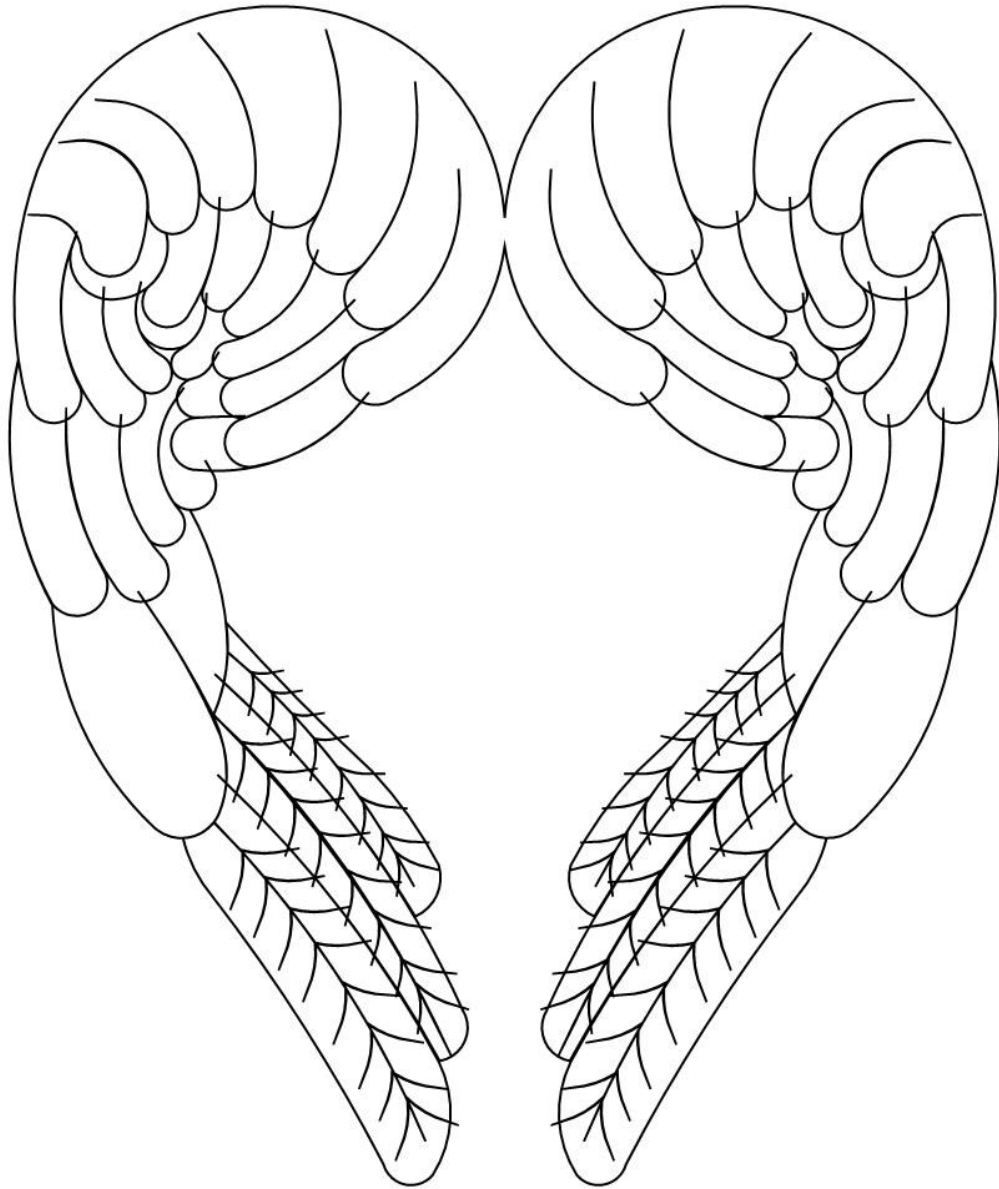

Pattern: feathered heart 002

Archive: Onyx Earl

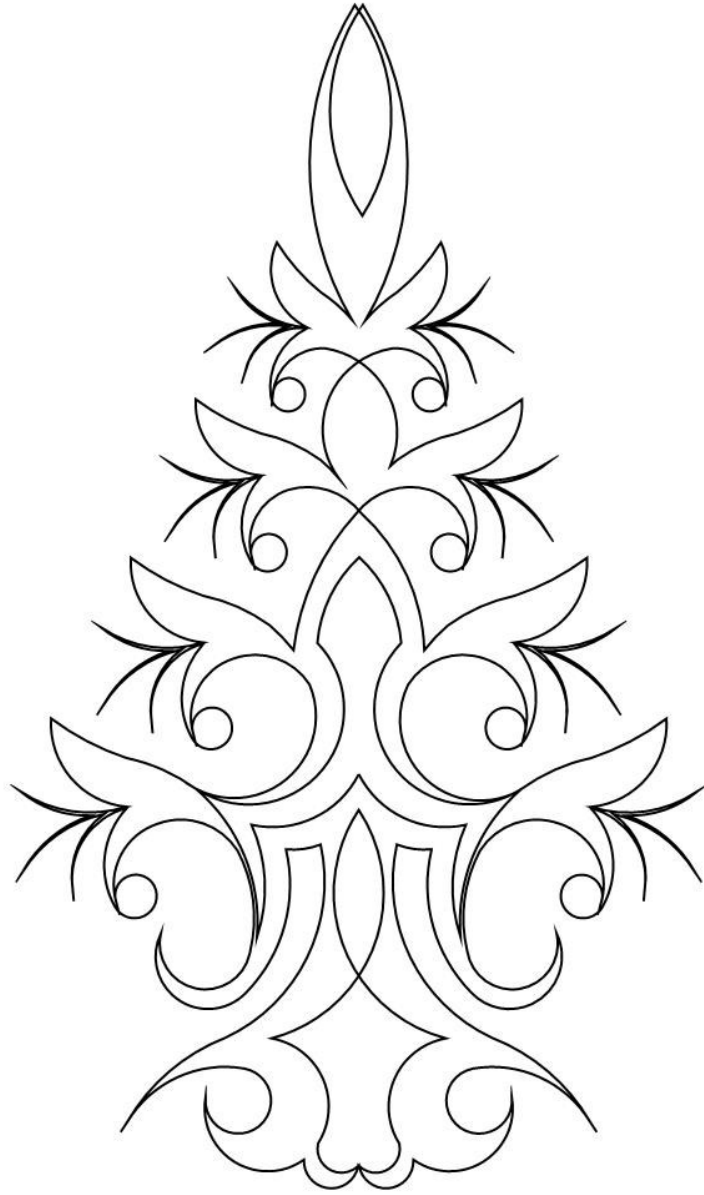

Pattern: feathered star pt 001

Archive: Onyx Earl

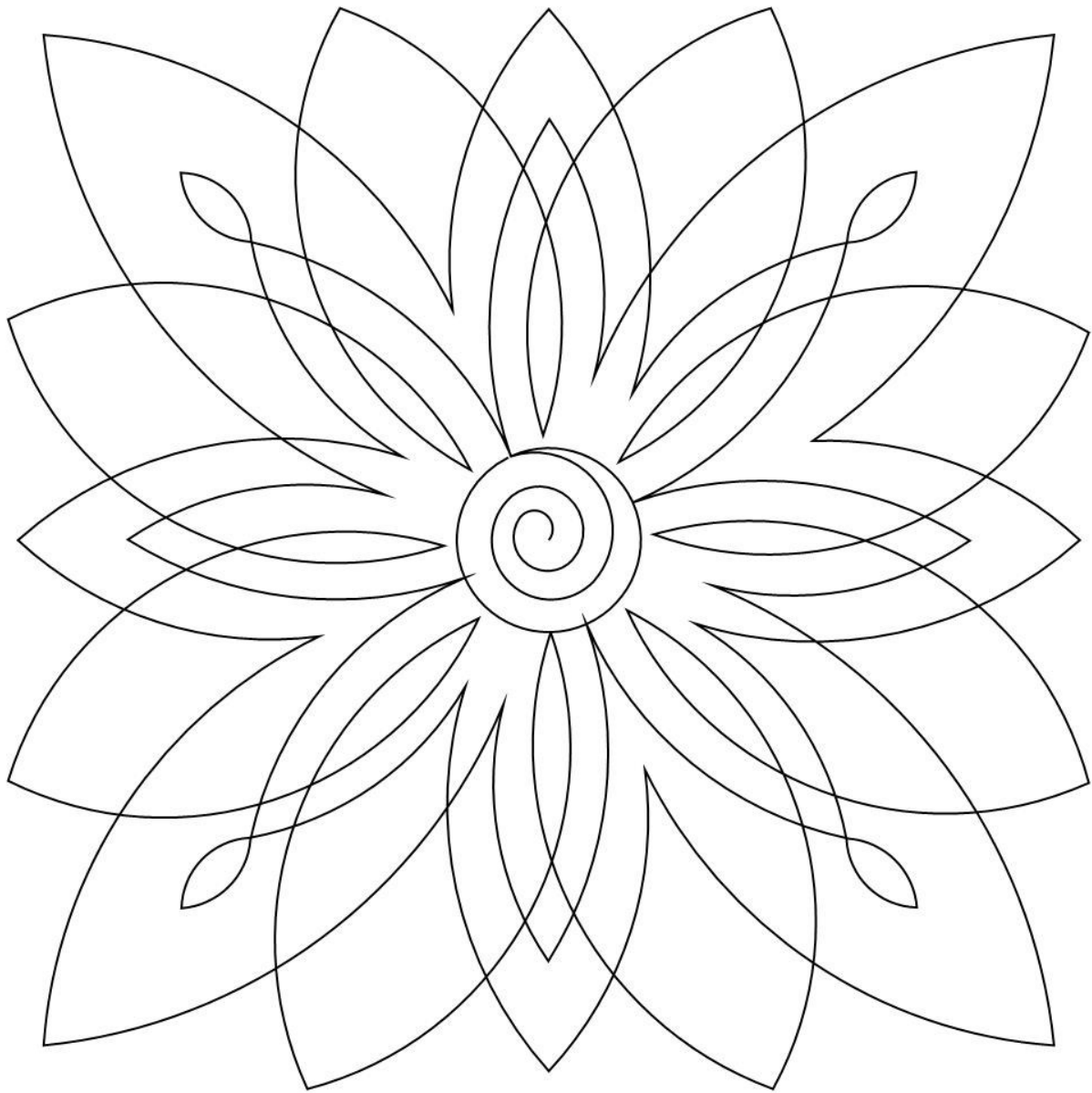

Pattern: feathered star sq 001

Archive: Onyx Earl

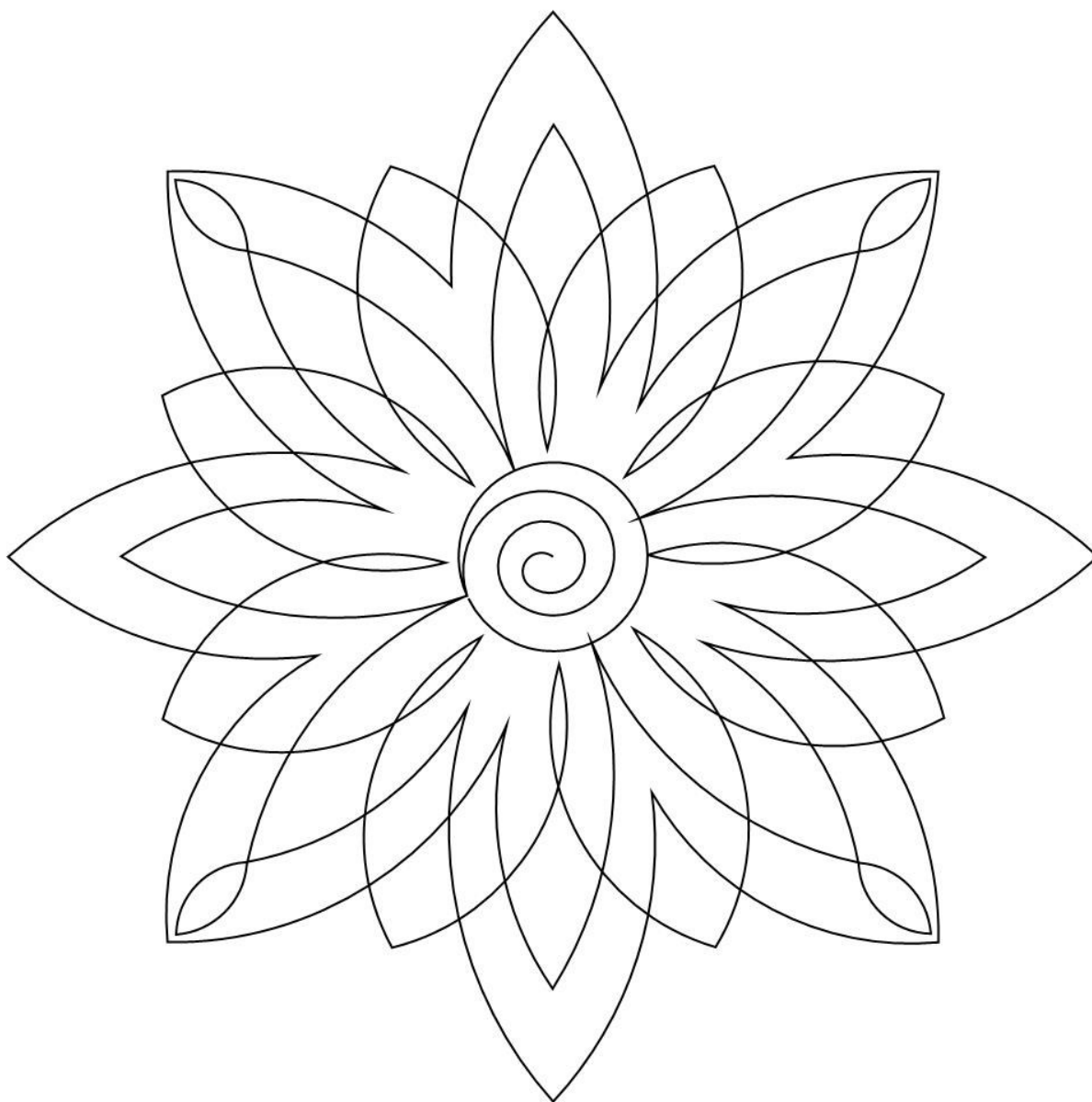

Pattern: feathered star sq 002

Archive: Onyx Earl

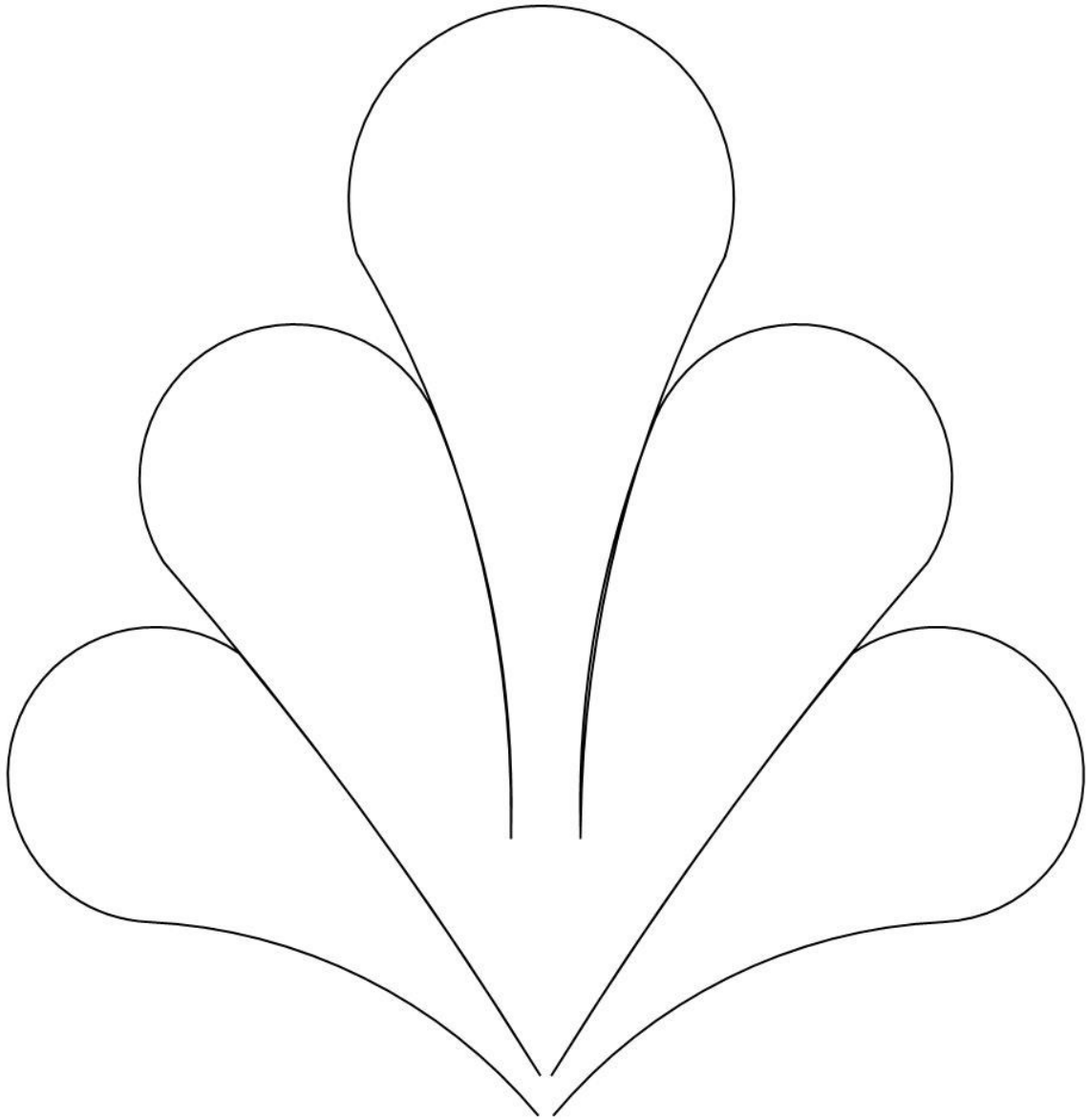

Pattern: feathered star sq 002 pt

Archive: Onyx Earl



Pattern: flying monkey block 001

Archive: Onyx Earl

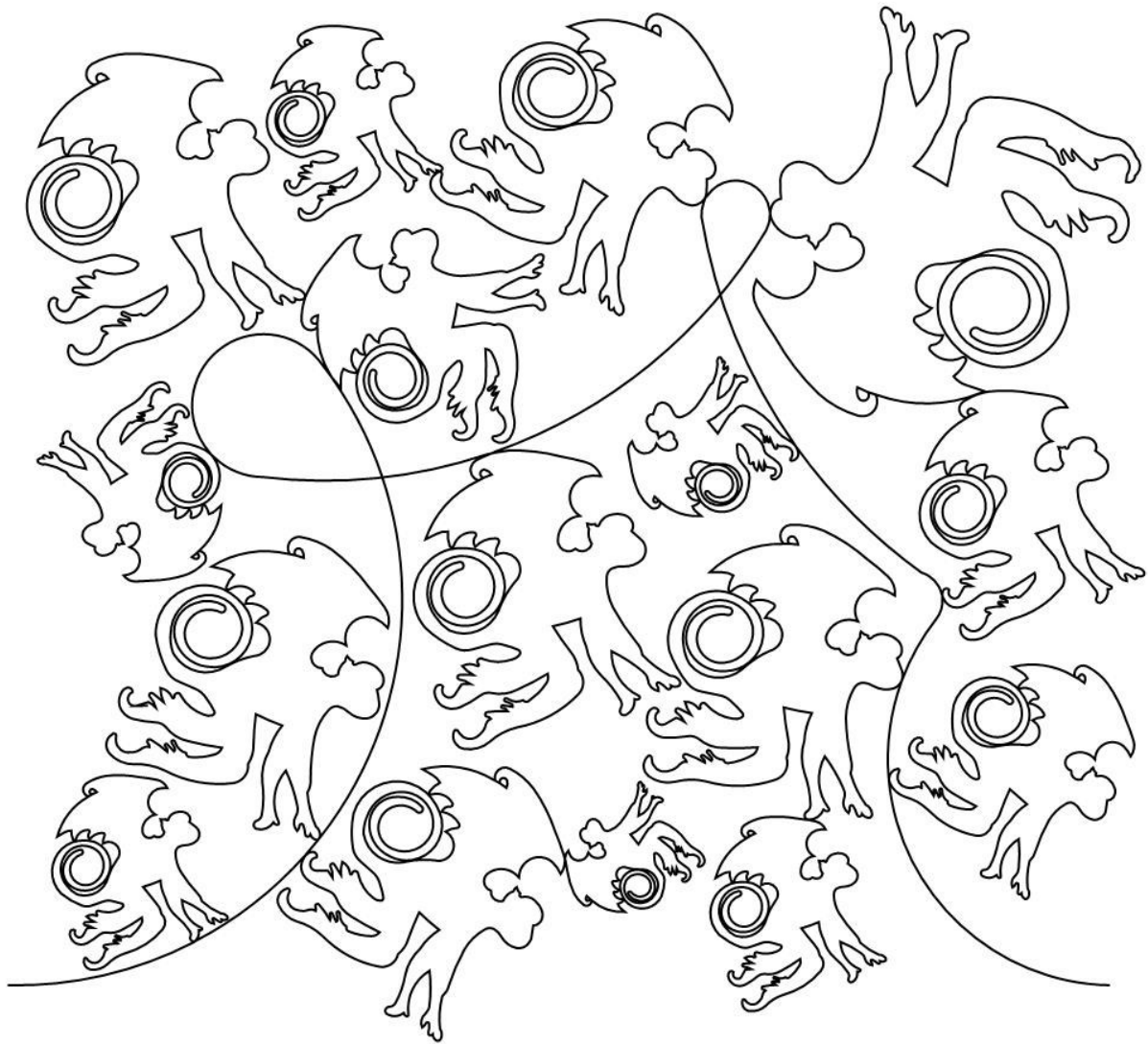

Pattern: flying monkey pano 001

Archive: Onyx Earl

Galveston Texas

Pattern: galveston

Archive: Onyx Earl

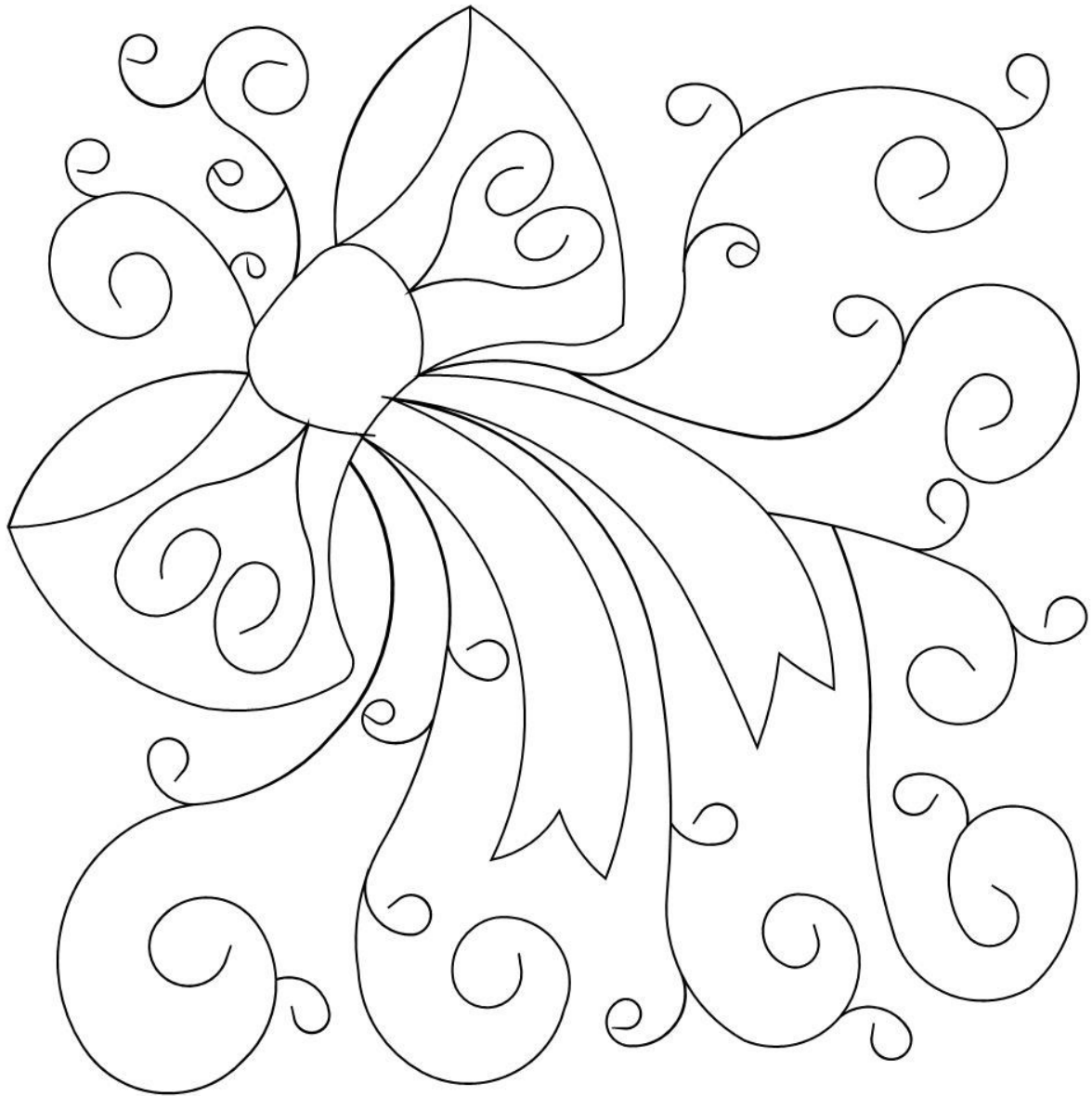

Pattern: gift block 001

Archive: Onyx Earl



Pattern: guns and roses pano 001

Archive: Onyx Earl

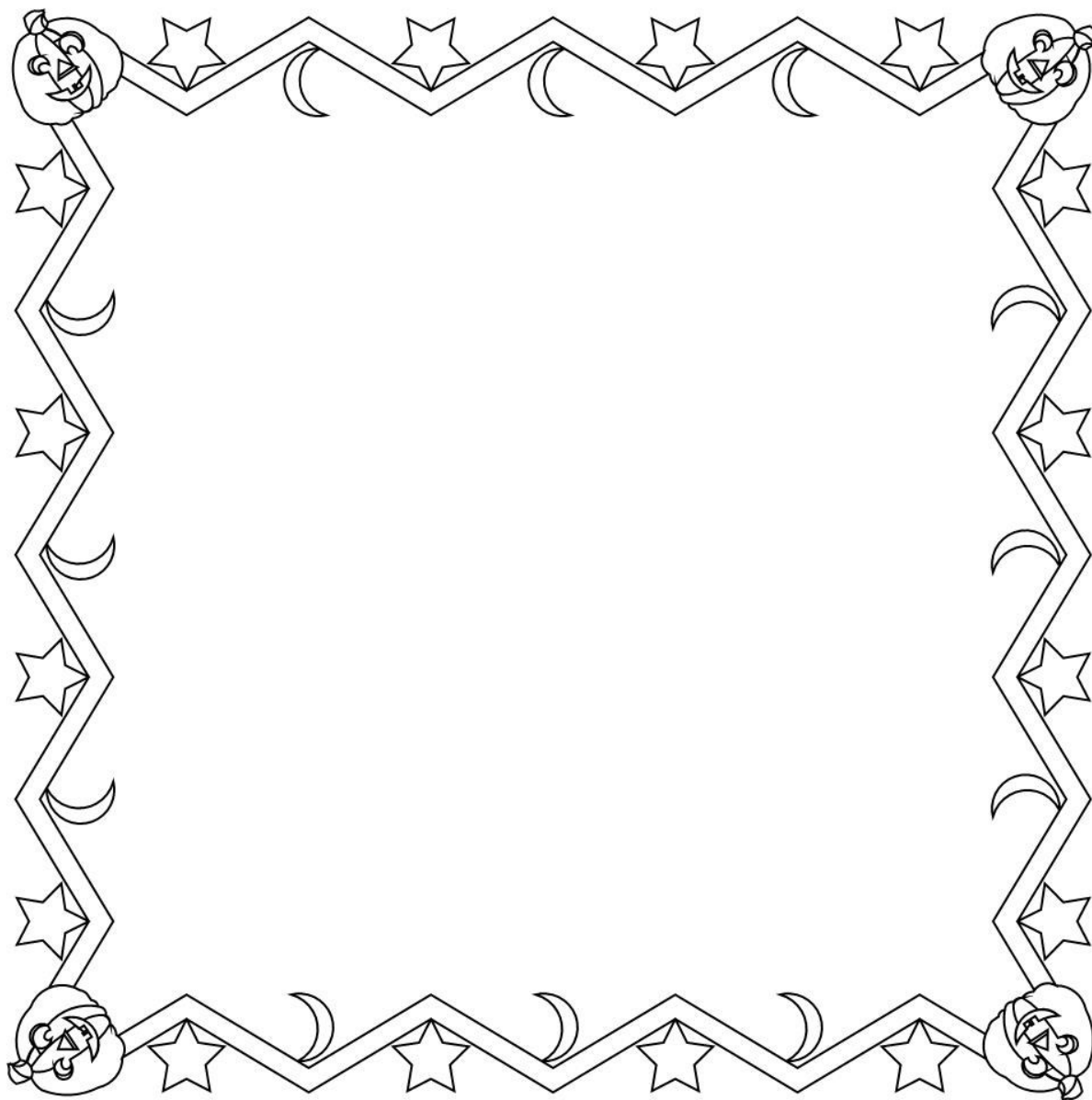

Pattern: halloween frame

Archive: Onyx Earl

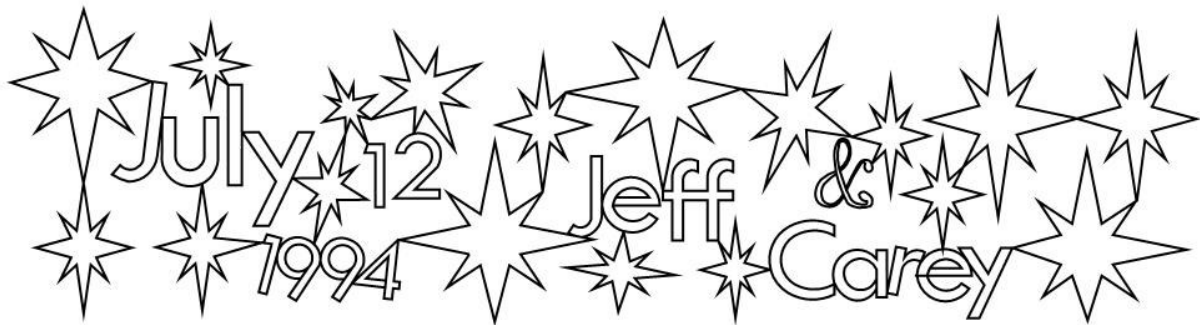

Pattern: harriet minnesota border

Archive: Onyx Earl



Pattern: hayden palm pano 001

Archive: Onyx Earl

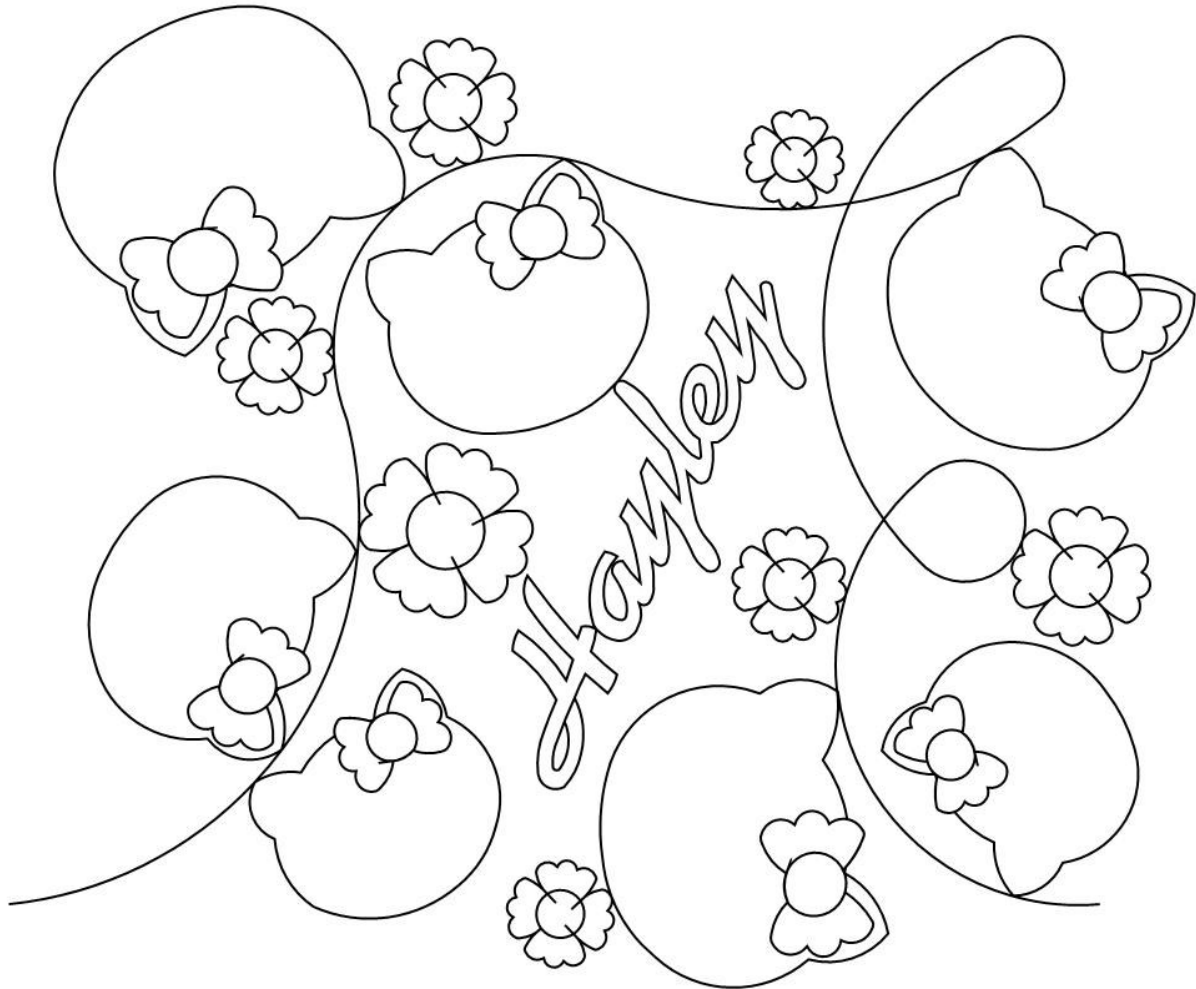

Pattern: hayley pano

Archive: Onyx Earl

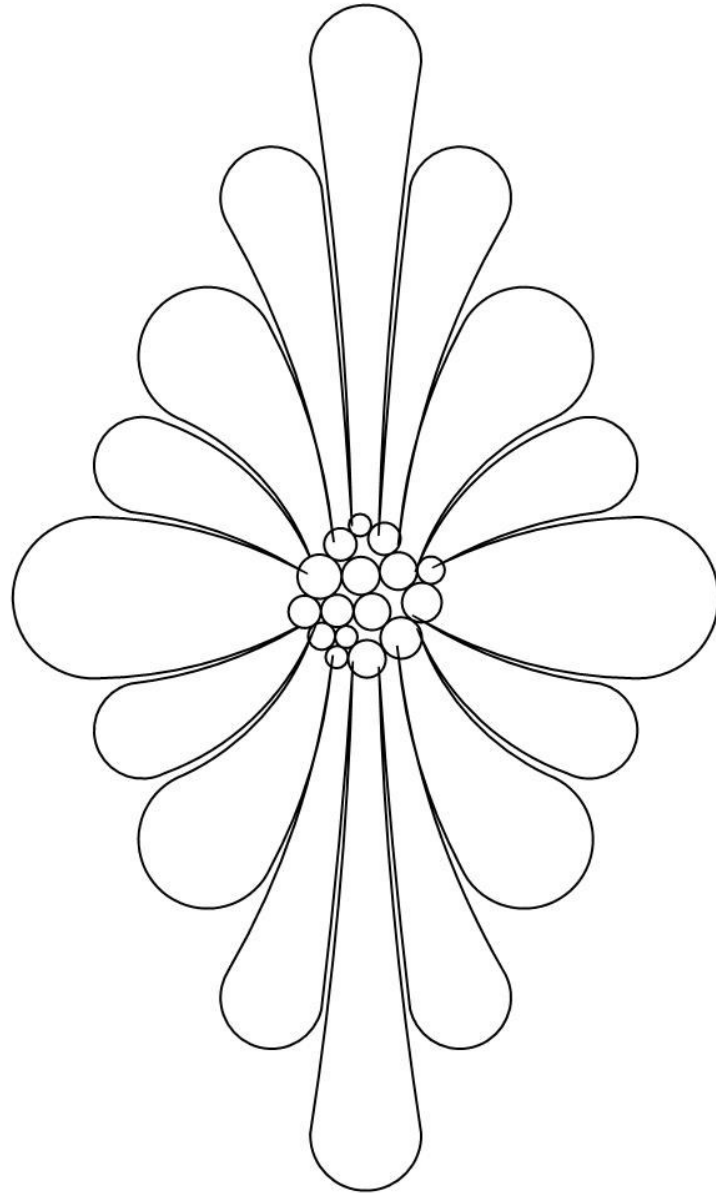

Pattern: hex flower 001

Archive: Onyx Earl

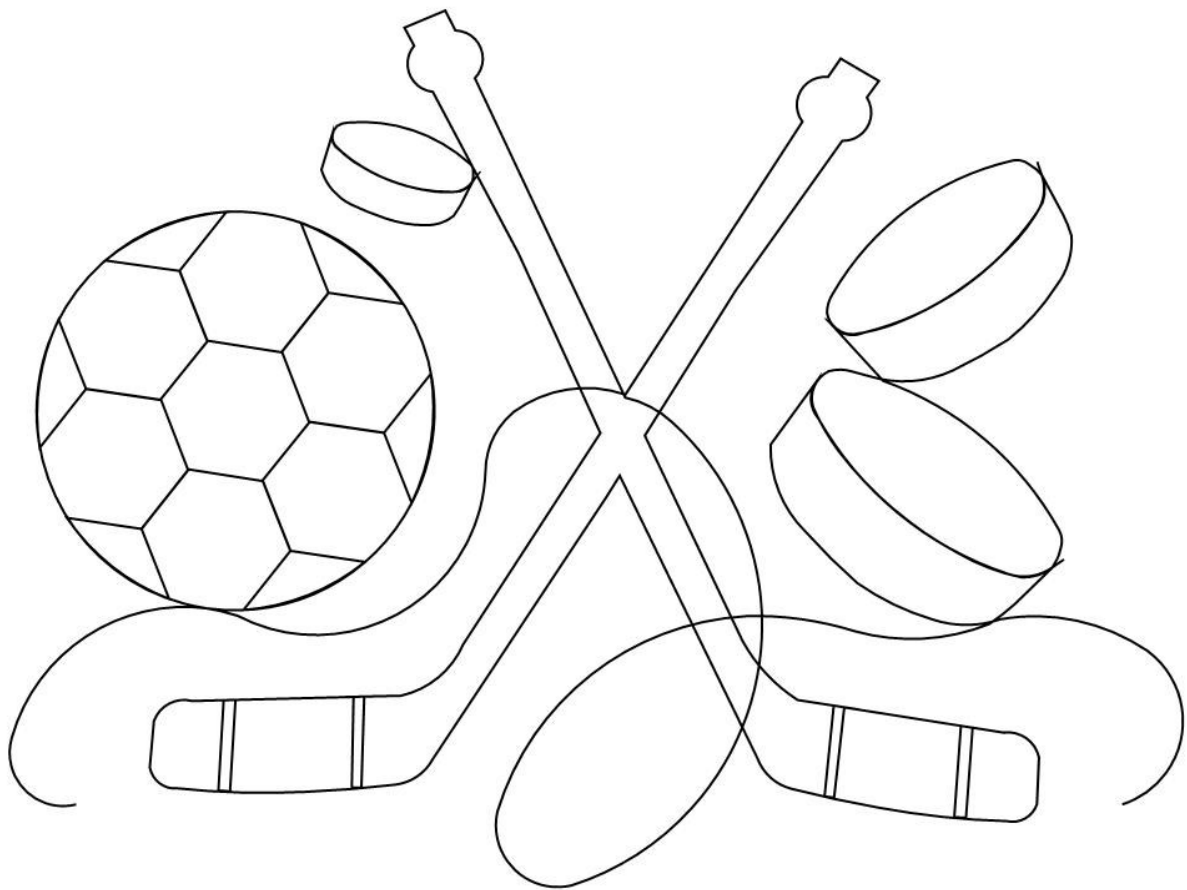

Pattern: hockey soccer pano

Archive: Onyx Earl

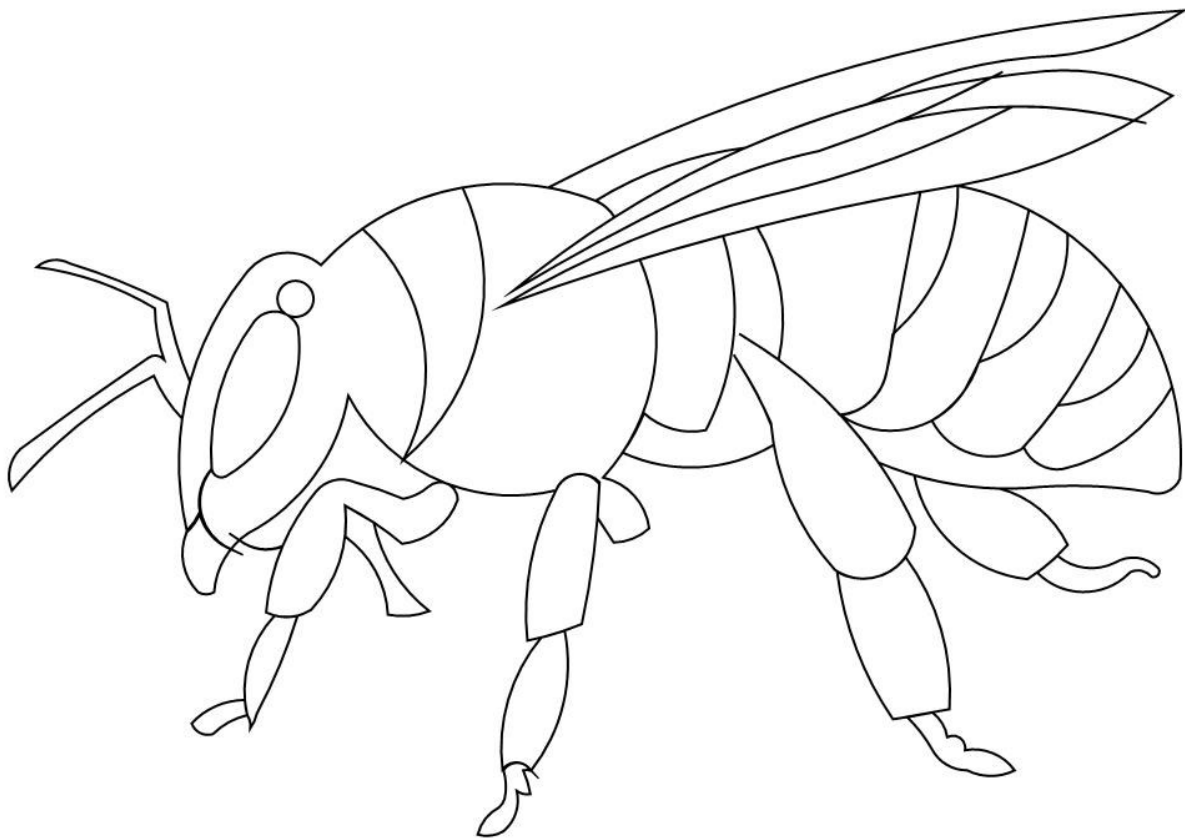

Pattern: honey bee 001

Archive: Onyx Earl

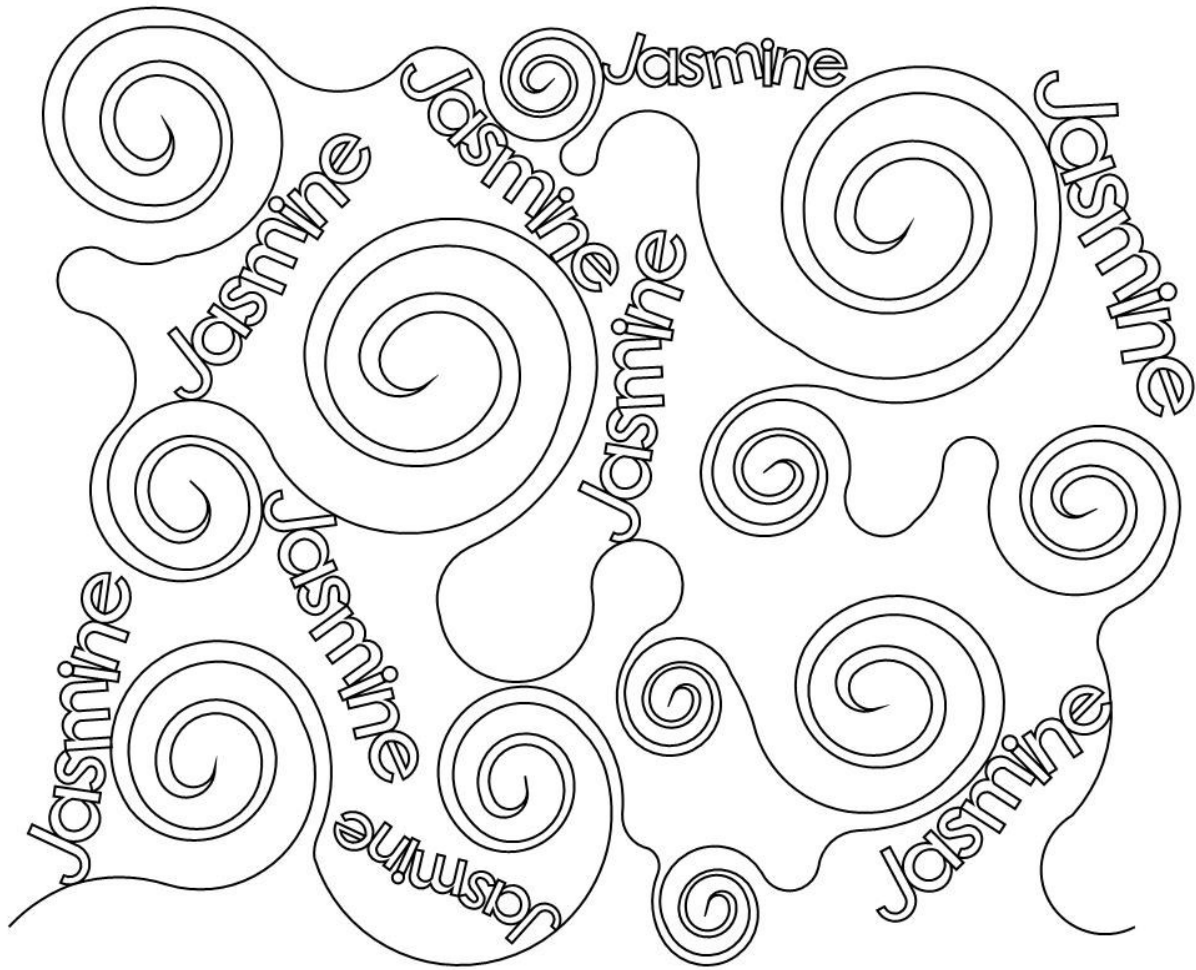

Pattern: jasmine pano 001

Archive: Onyx Earl

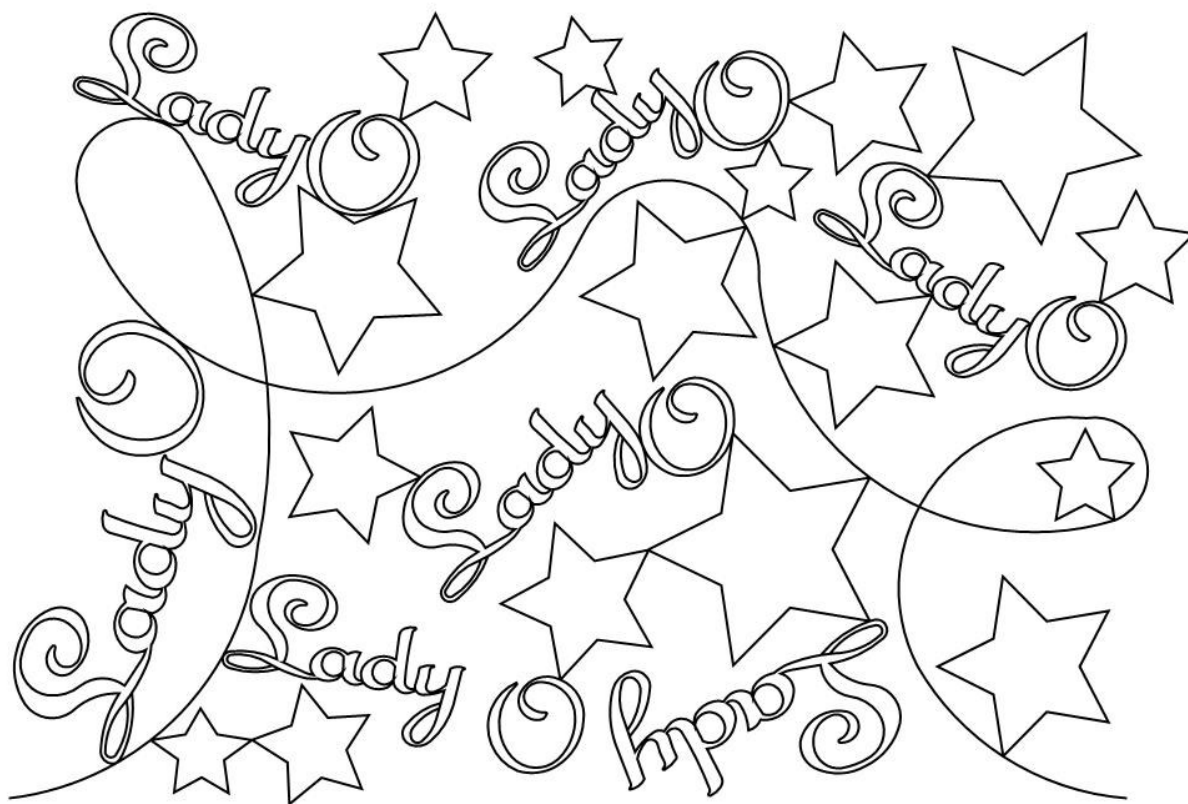

Pattern: lady o pano

Archive: Onyx Earl

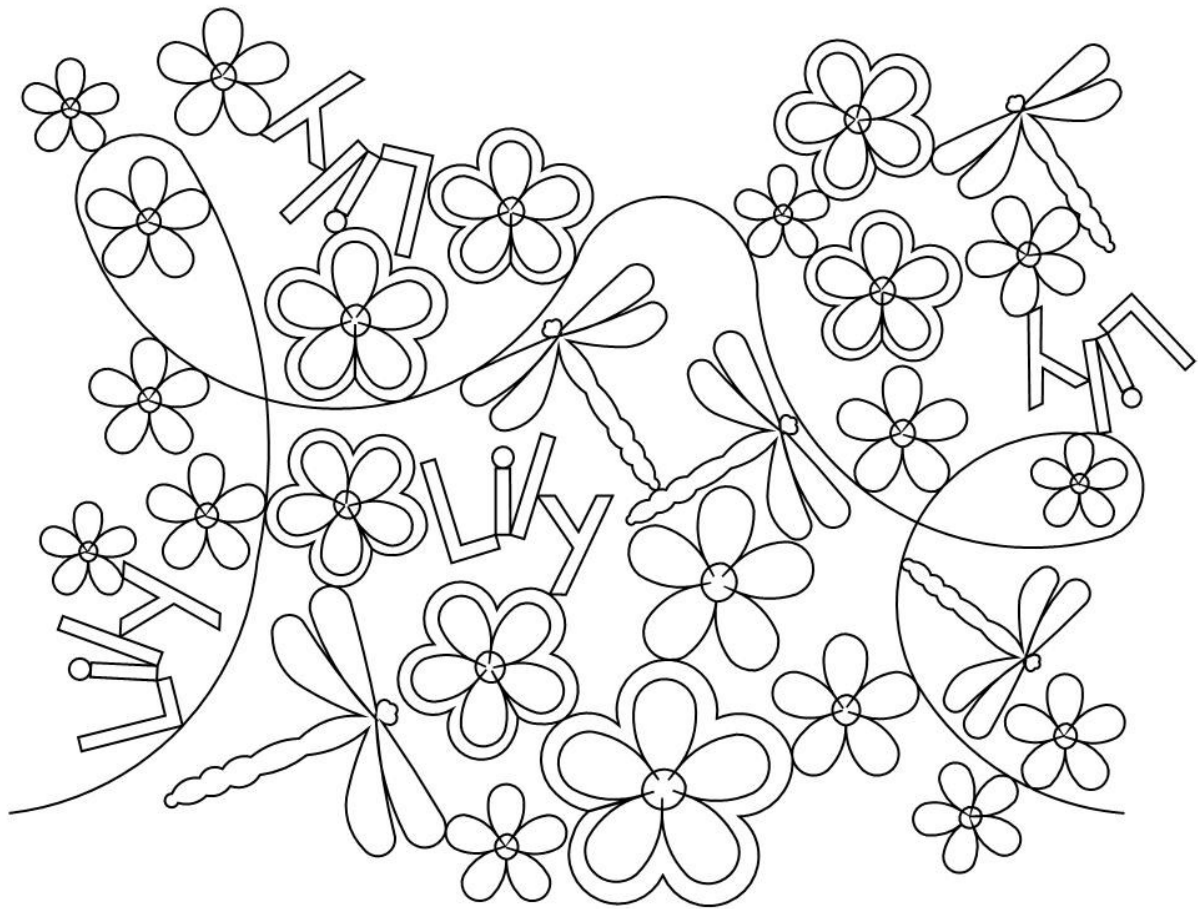

Pattern: lily pano 002

Archive: Onyx Earl

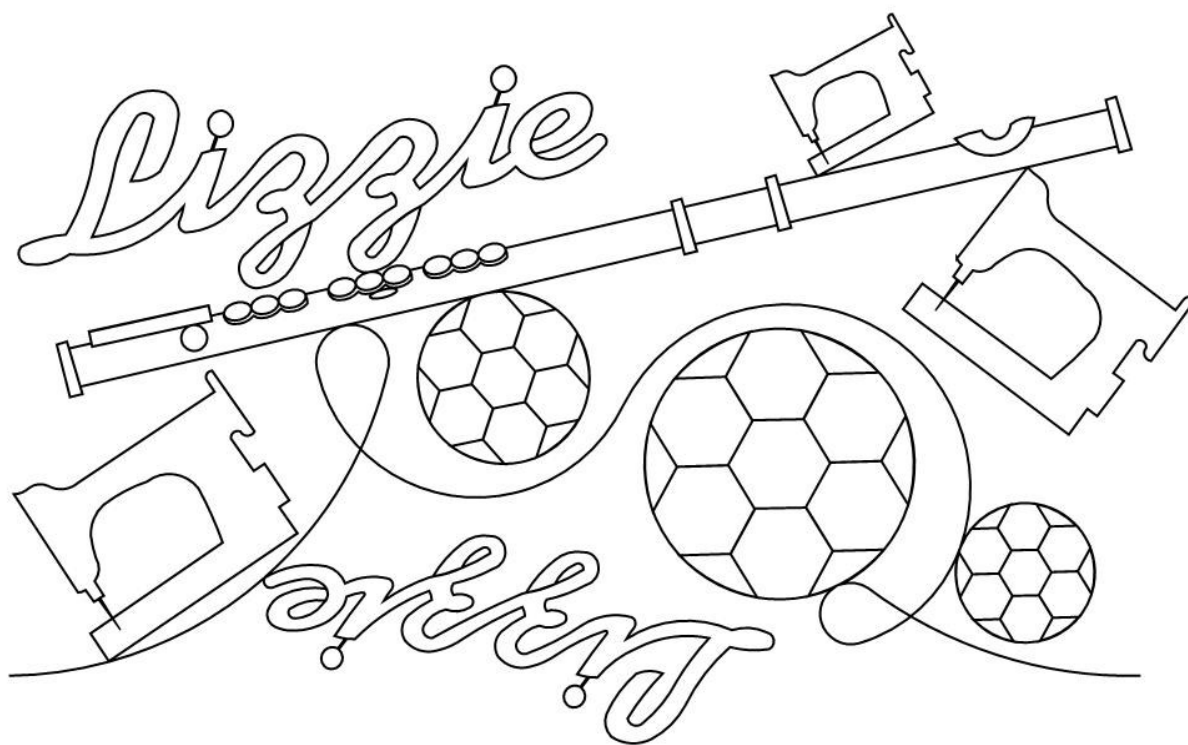

Pattern: lizzie pano 001

Archive: Onyx Earl

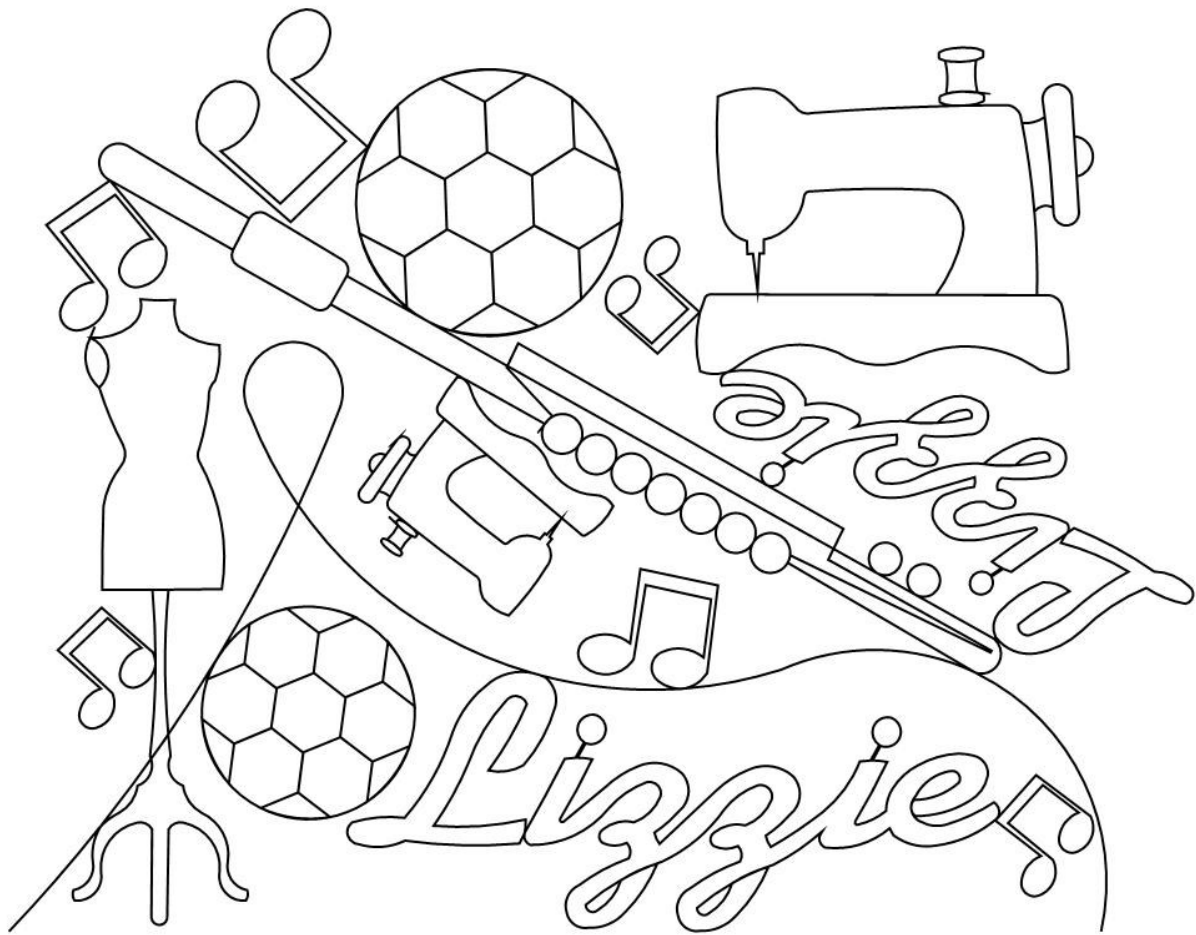

Pattern: lizzie pano 002

Archive: Onyx Earl

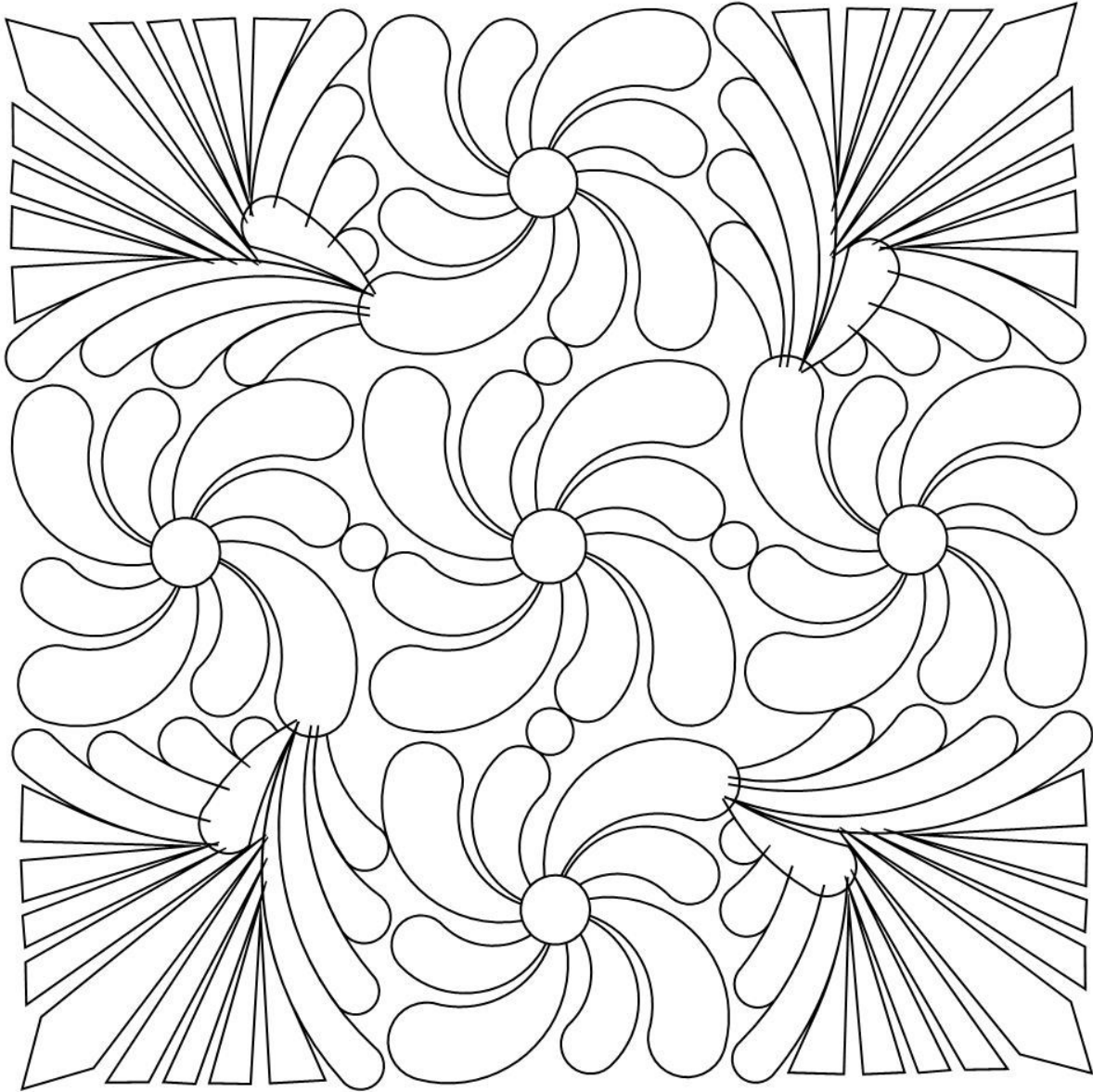

Pattern: lori feather block 001

Archive: Onyx Earl

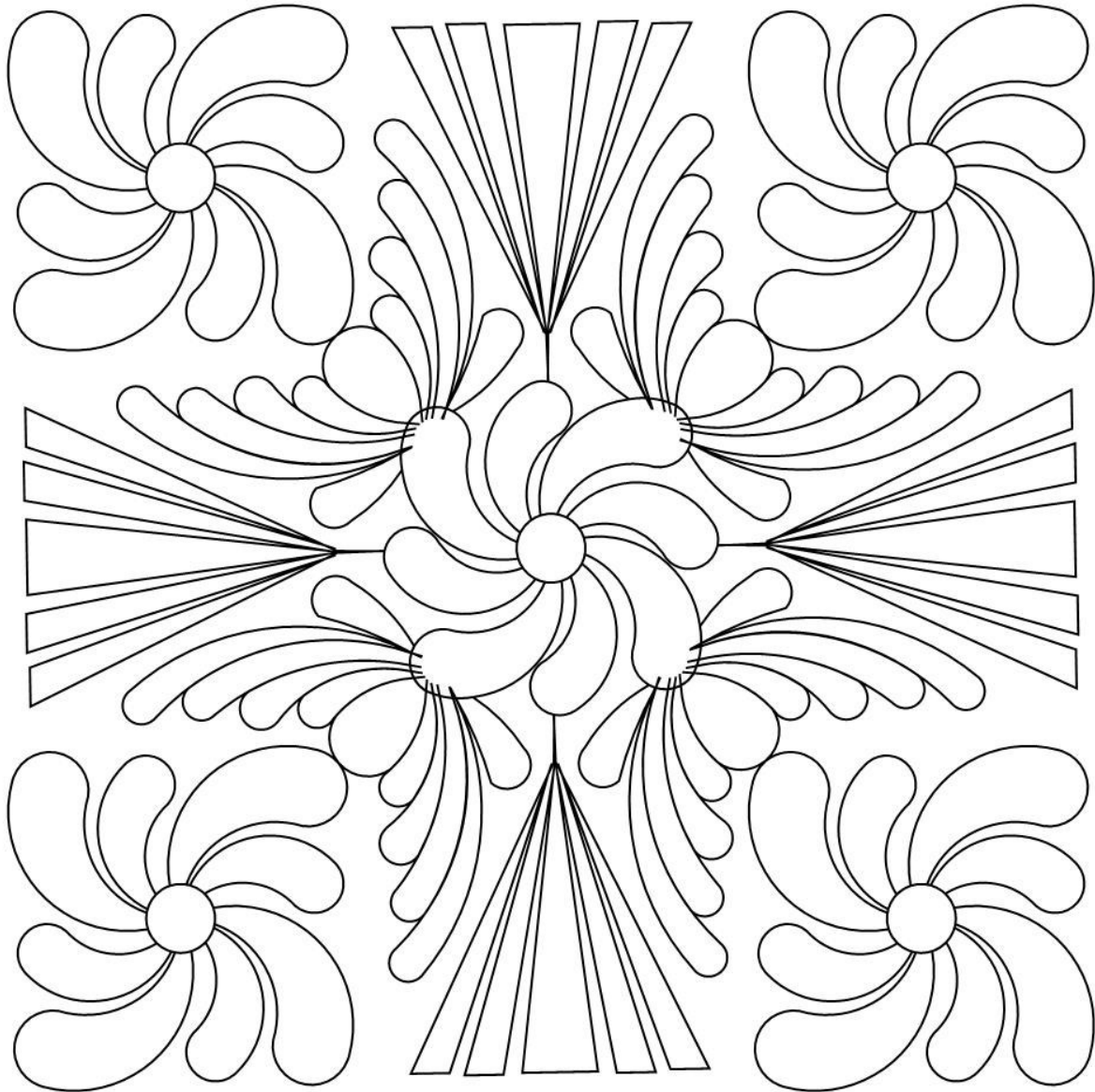

Pattern: lori feather block 002

Archive: Onyx Earl

Sewn By

Quilted By

Date

Pattern: made by label 002

Archive: Onyx Earl

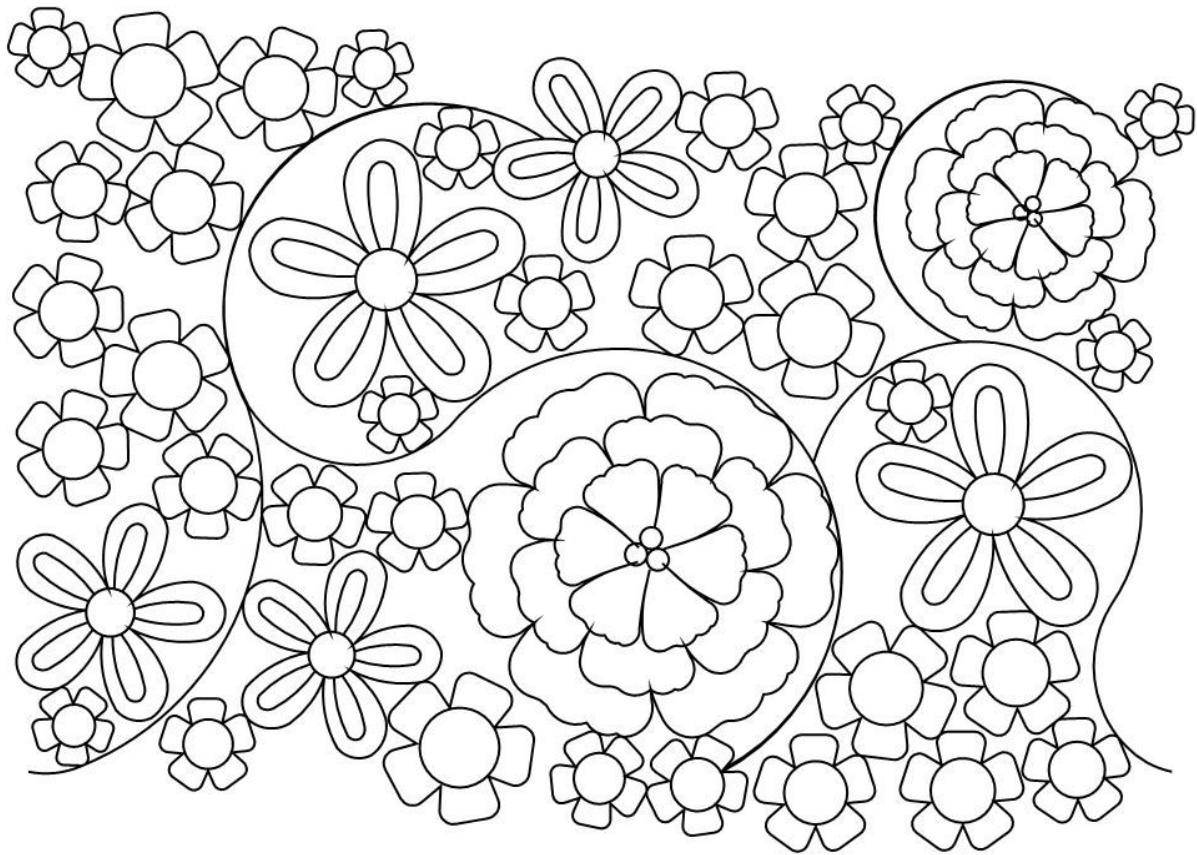

Pattern: mitzi pano 001

Archive: Onyx Earl

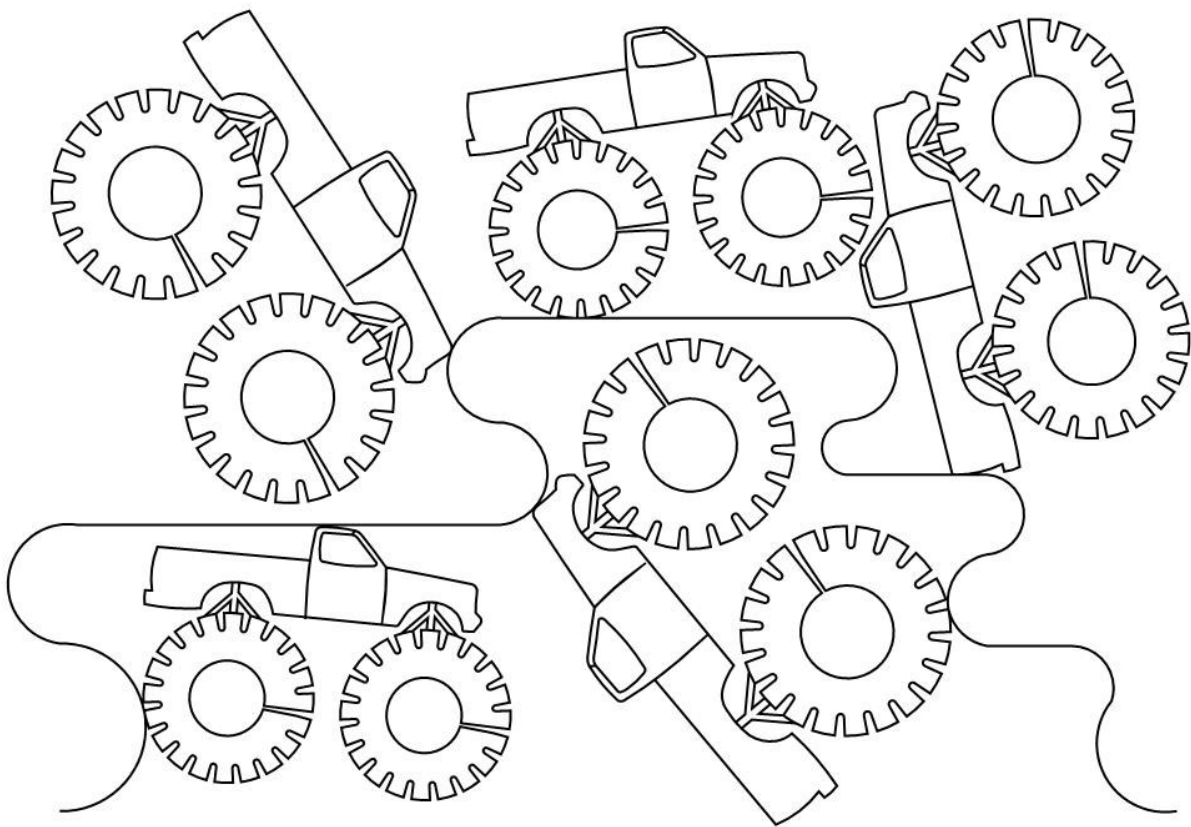

Pattern: monster truck pano 001

Archive: Onyx Earl

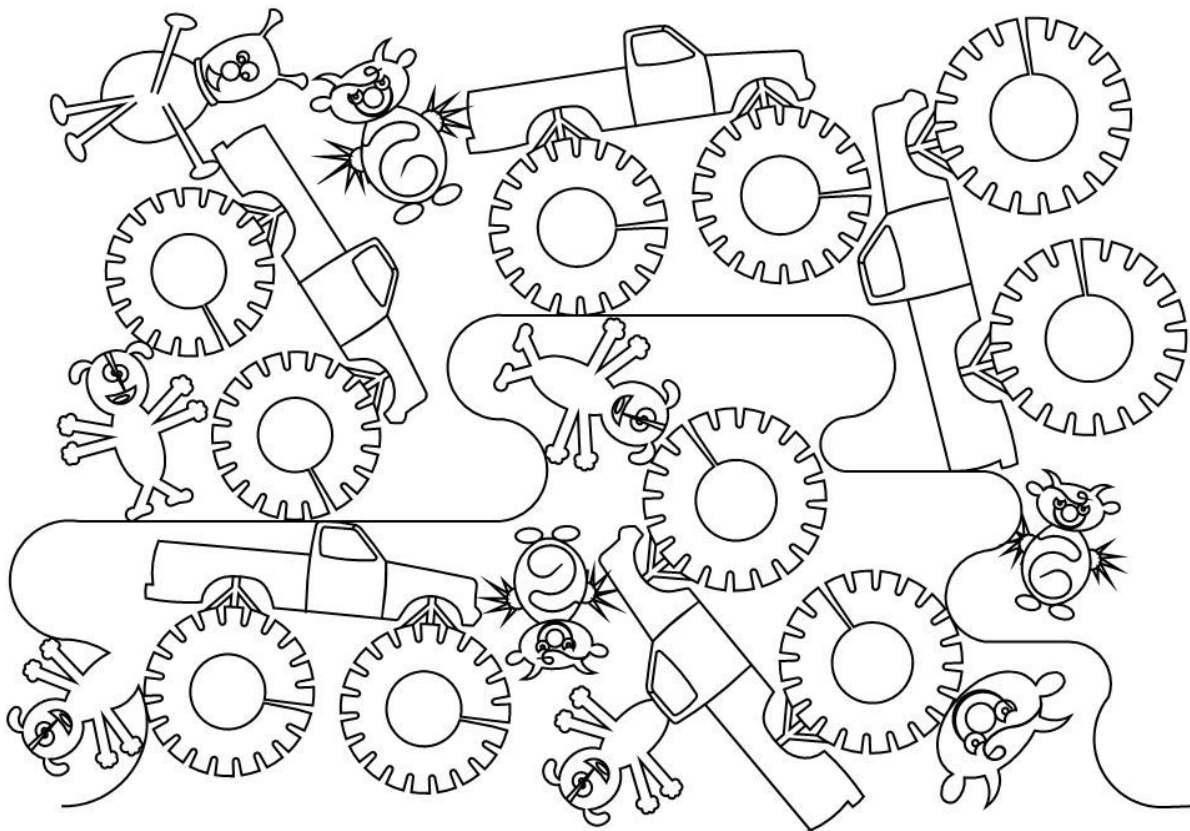

Pattern: monster truck pano 002

Archive: Onyx Earl

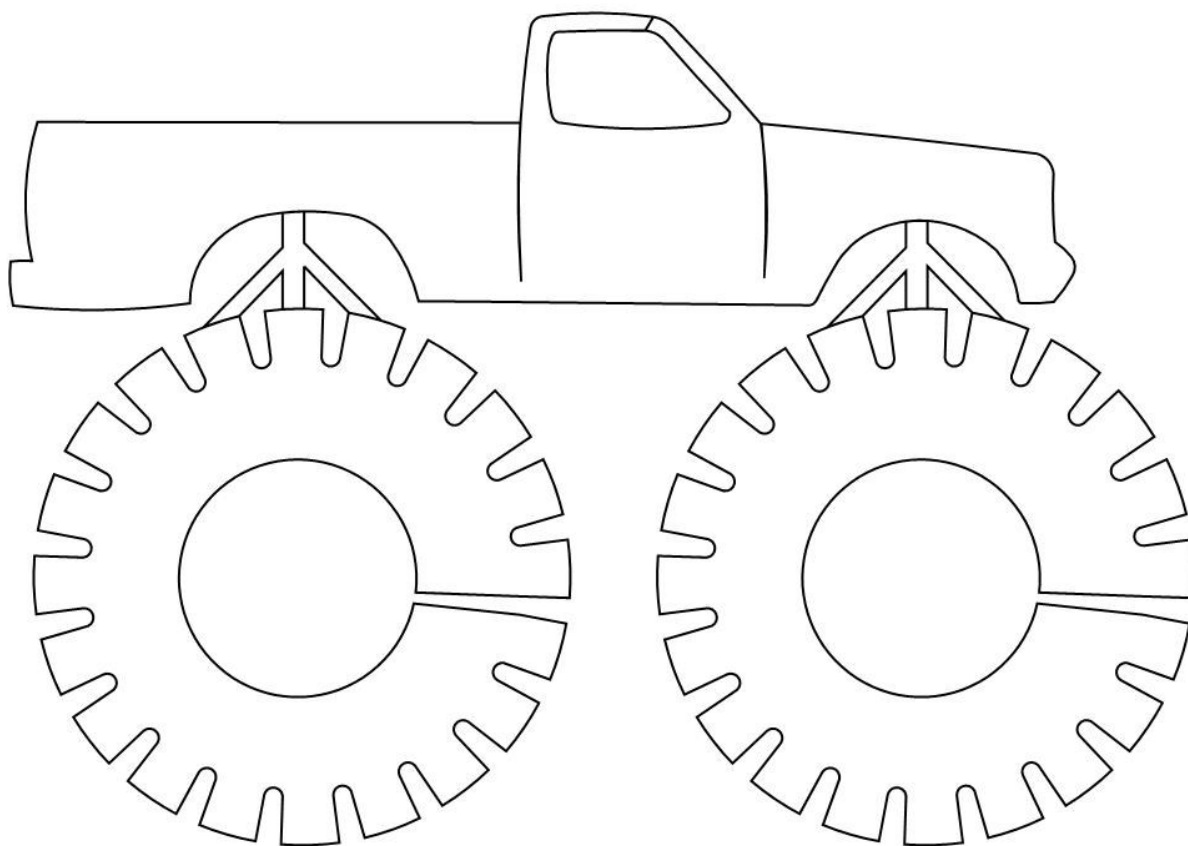

Pattern: monster truck single

Archive: Onyx Earl

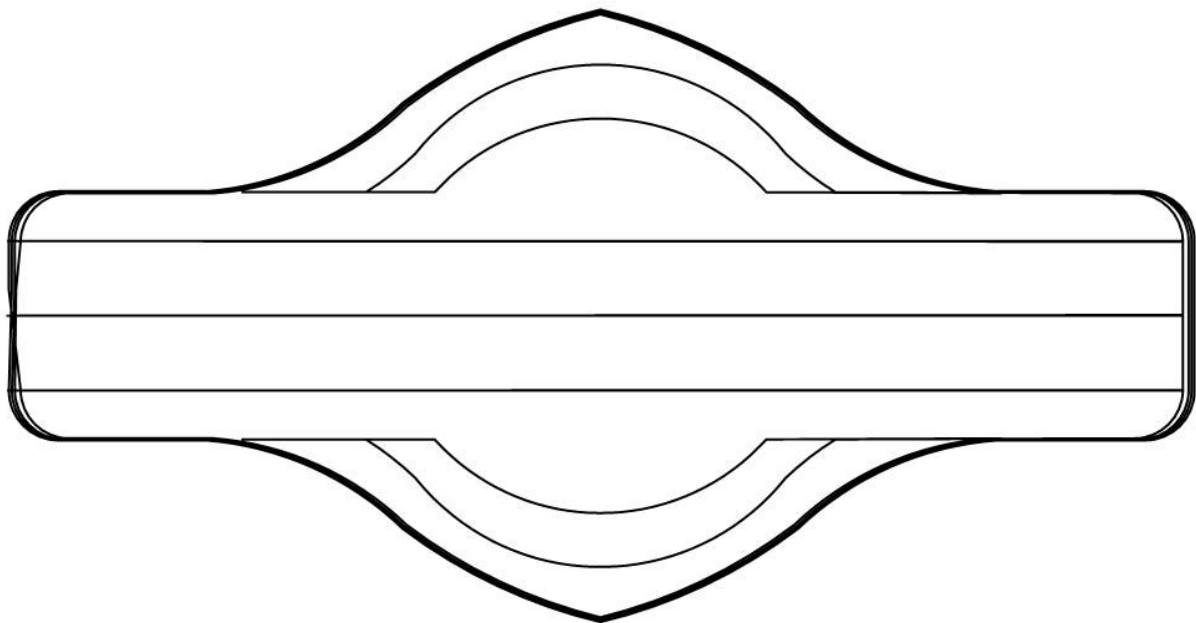

Pattern: napkin 1

Archive: Onyx Earl

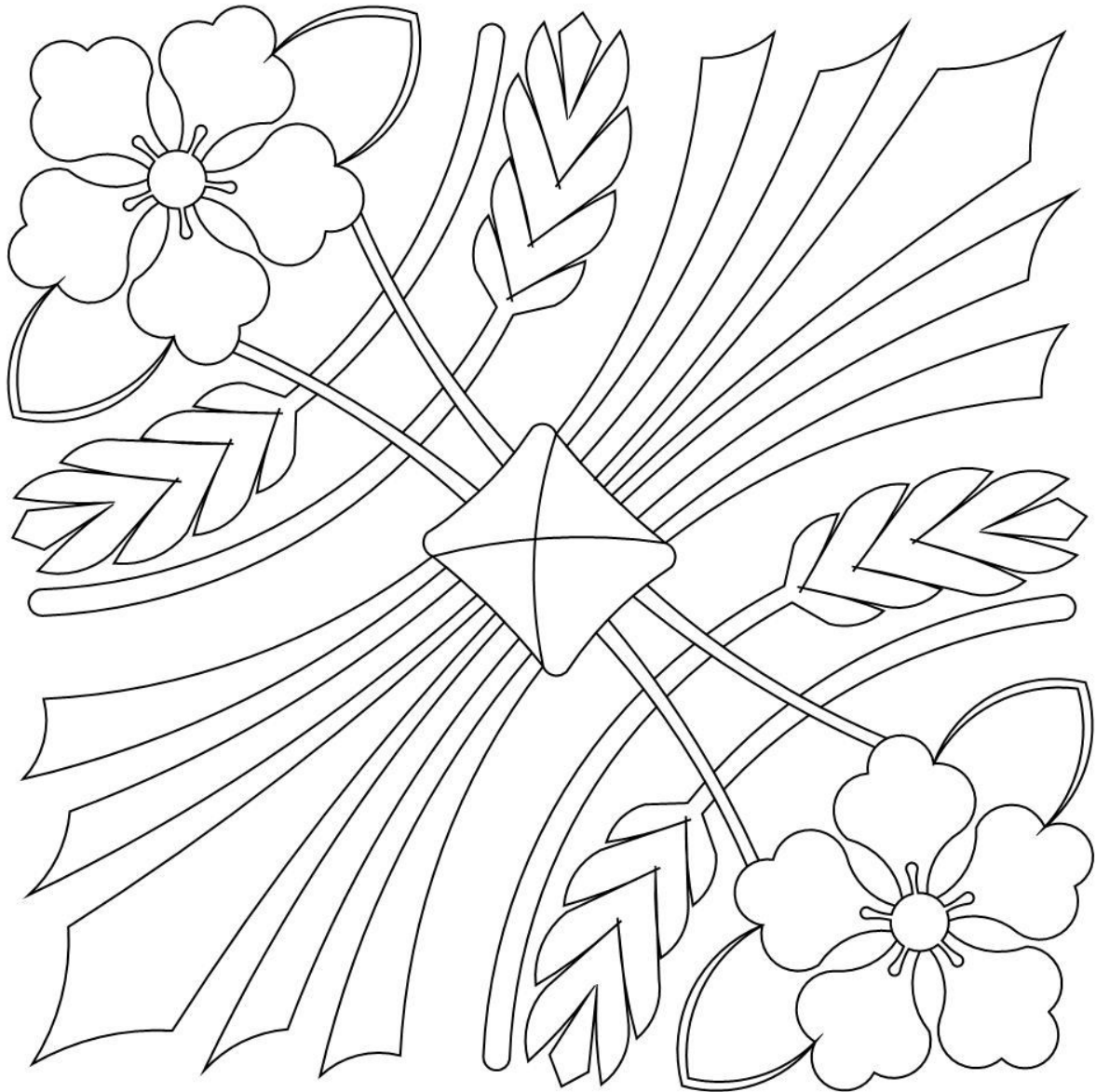

Pattern: oriental block 002

Archive: Onyx Earl

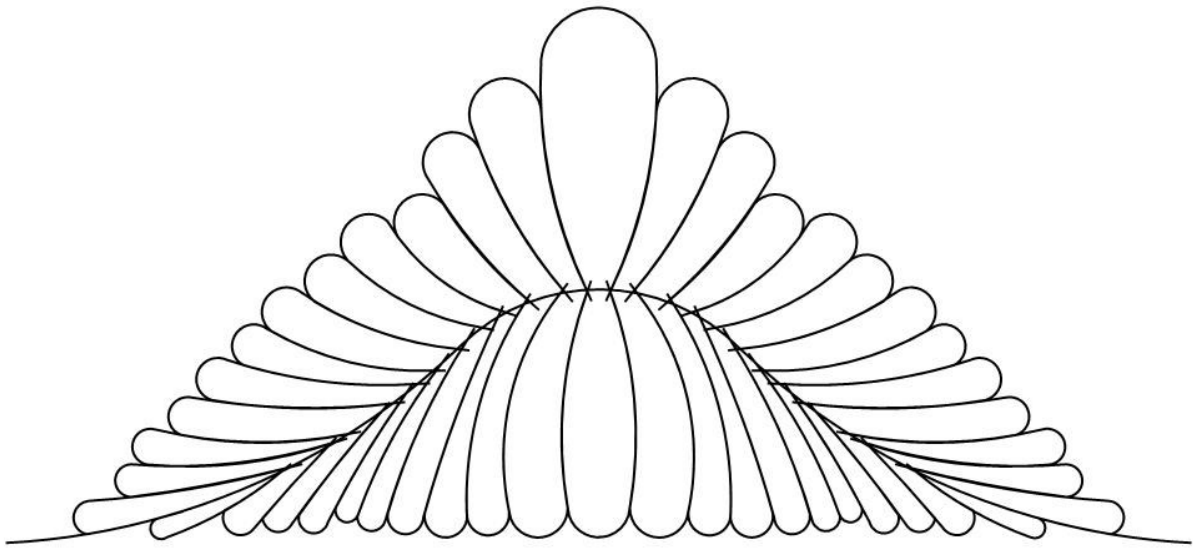

Pattern: p2p feather tri 006

Archive: Onyx Earl

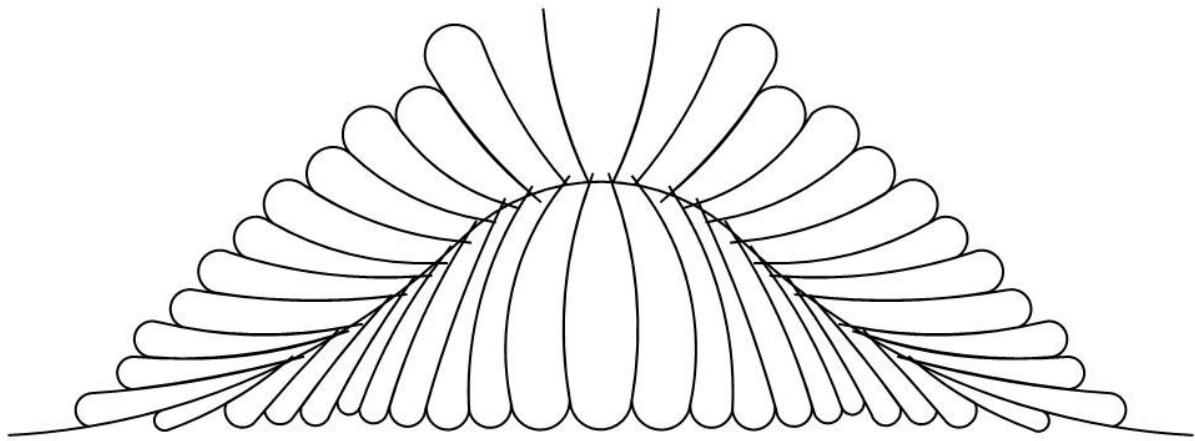

Pattern: p2p feather tri 006 a

Archive: Onyx Earl

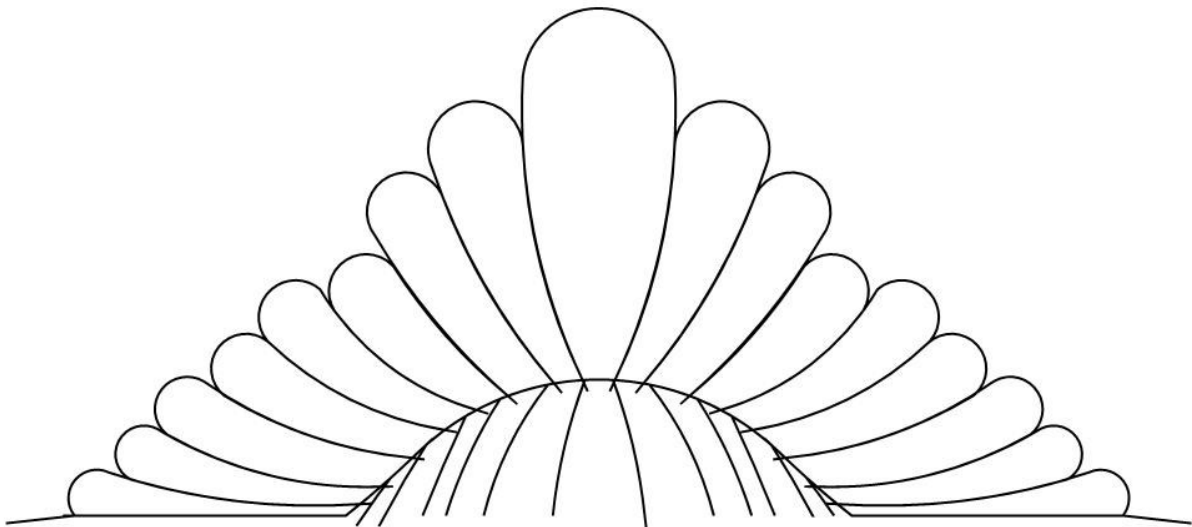

Pattern: p2p feather tri 006 b

Archive: Onyx Earl

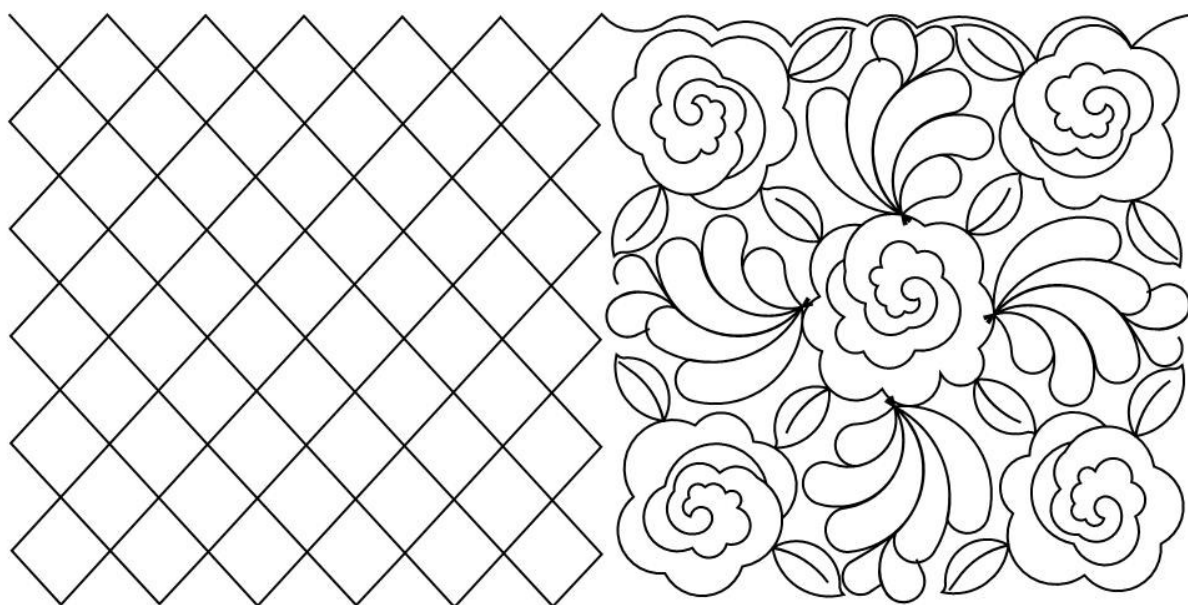

Pattern: p2p grid flower blk 001

Archive: Onyx Earl

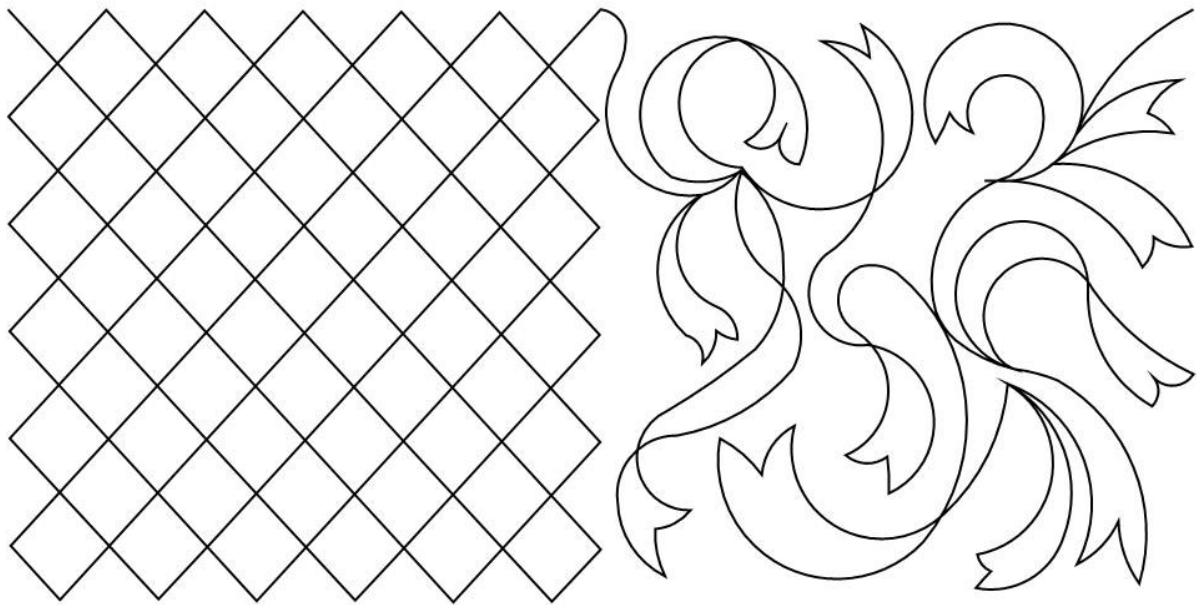

Pattern: p2p grid ribbon blk 001

Archive: Onyx Earl

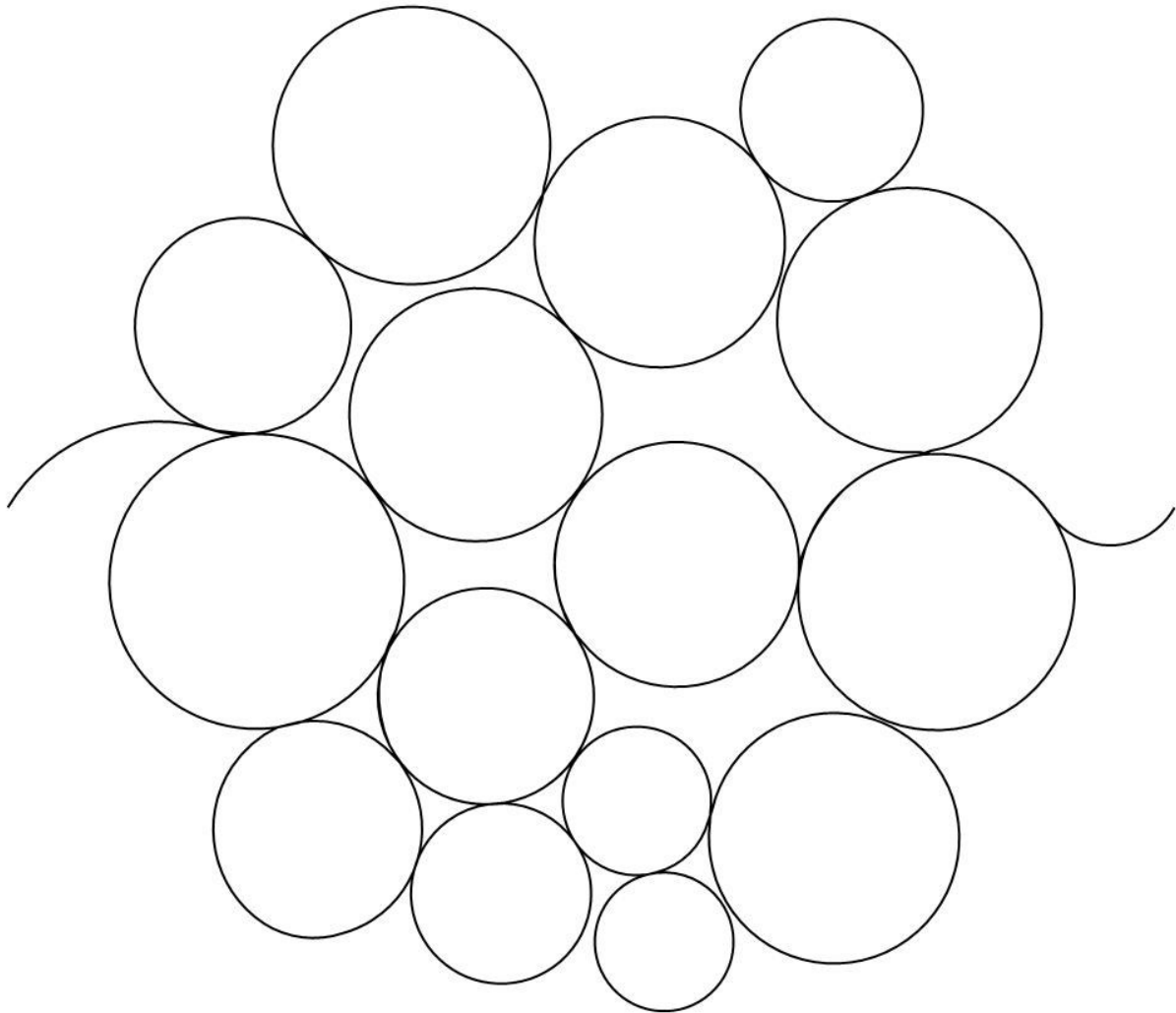

Pattern: p2p hex 001

Archive: Onyx Earl

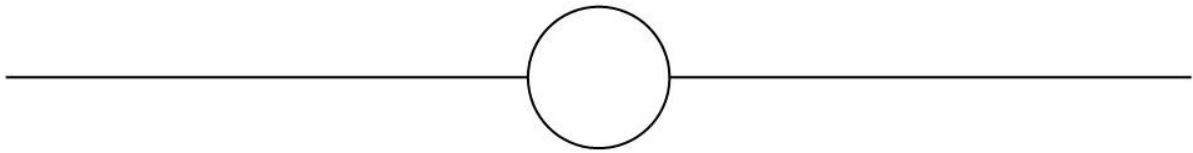

Pattern: p2p line circle 001

Archive: Onyx Earl

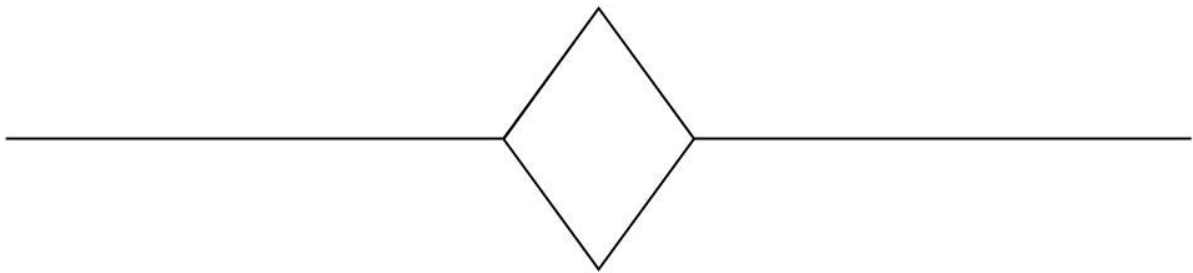

Pattern: p2p line diamond 001

Archive: Onyx Earl

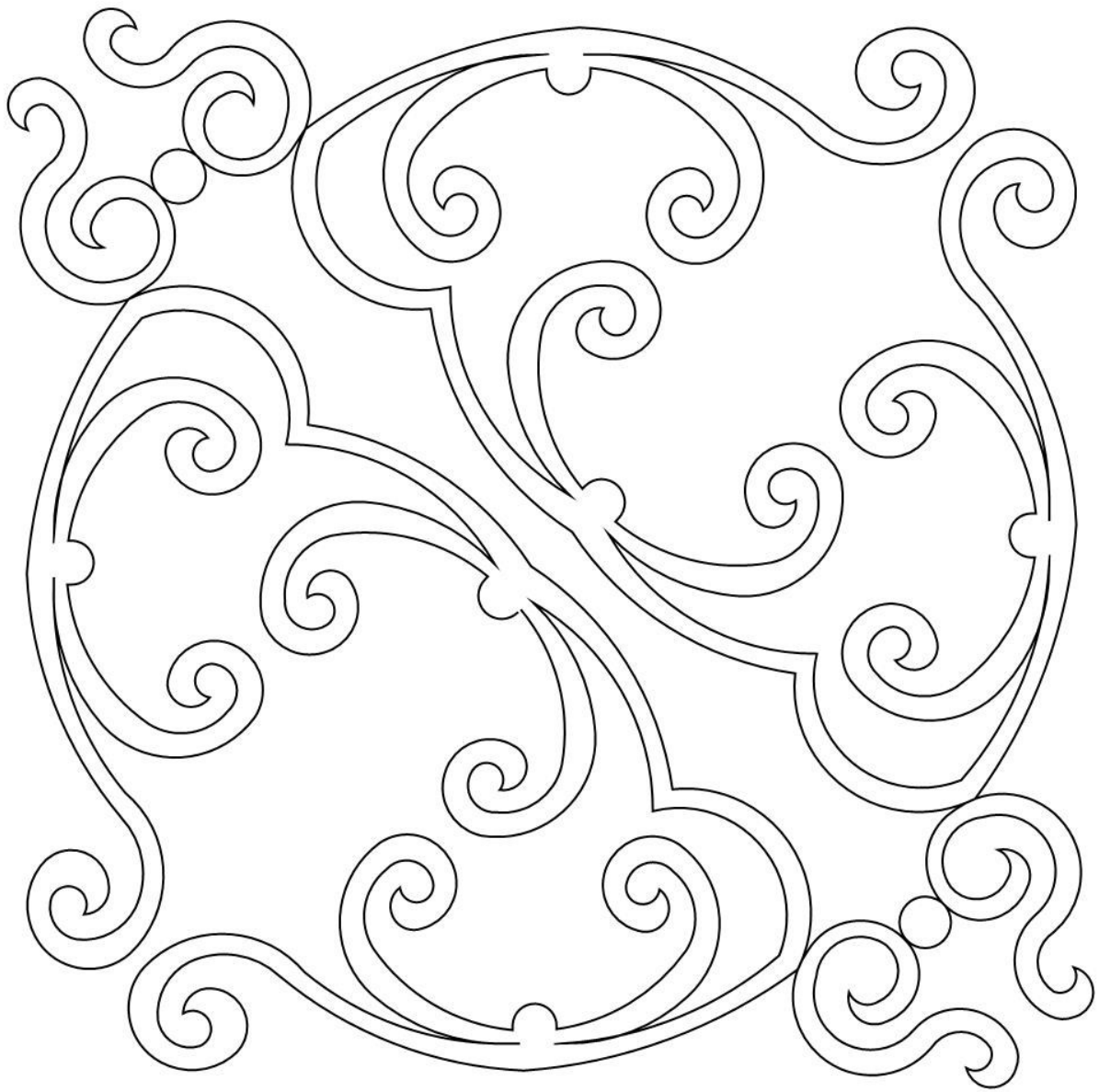

Pattern: passages block 001

Archive: Onyx Earl

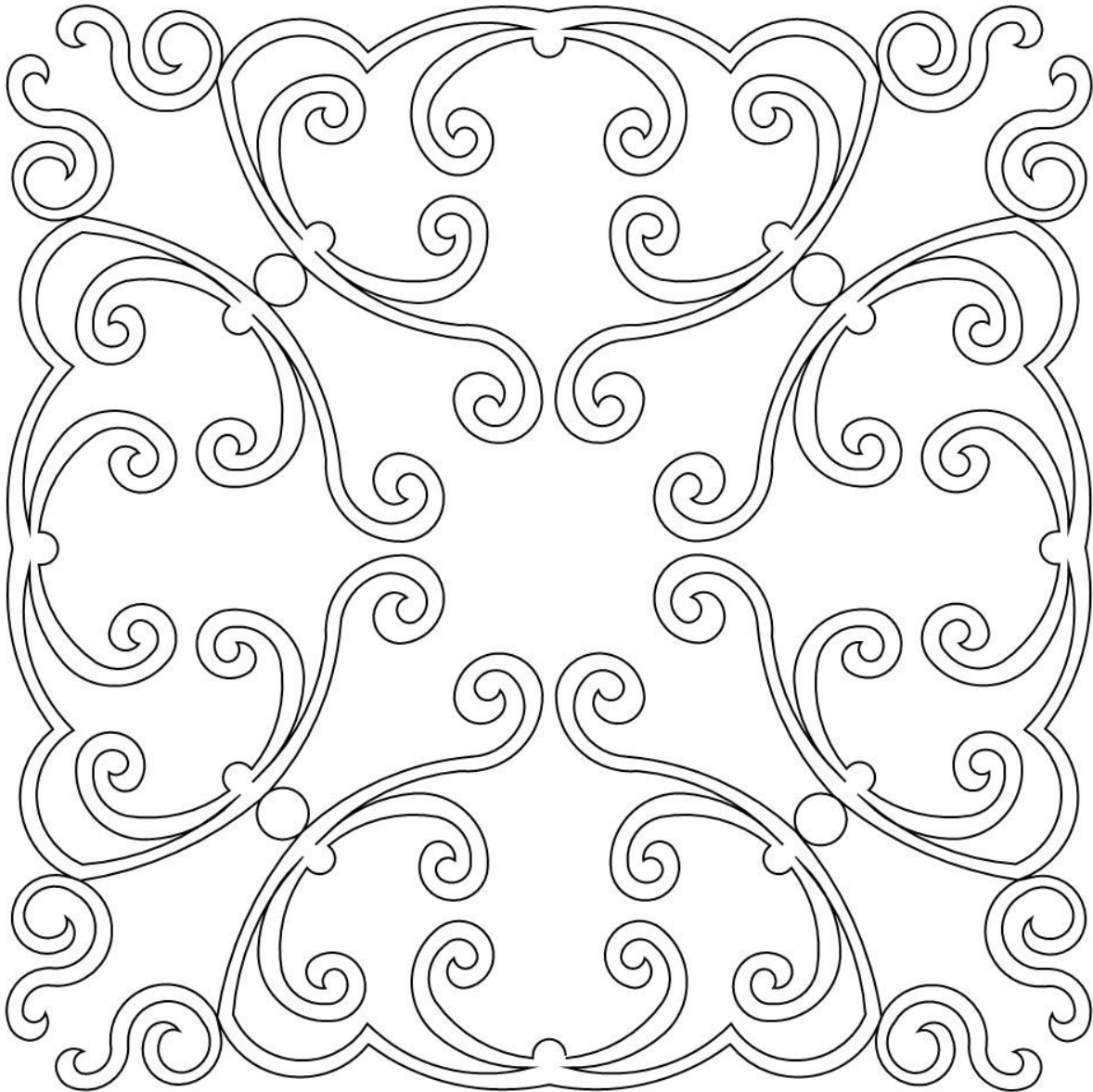

Pattern: passages block 002

Archive: Onyx Earl

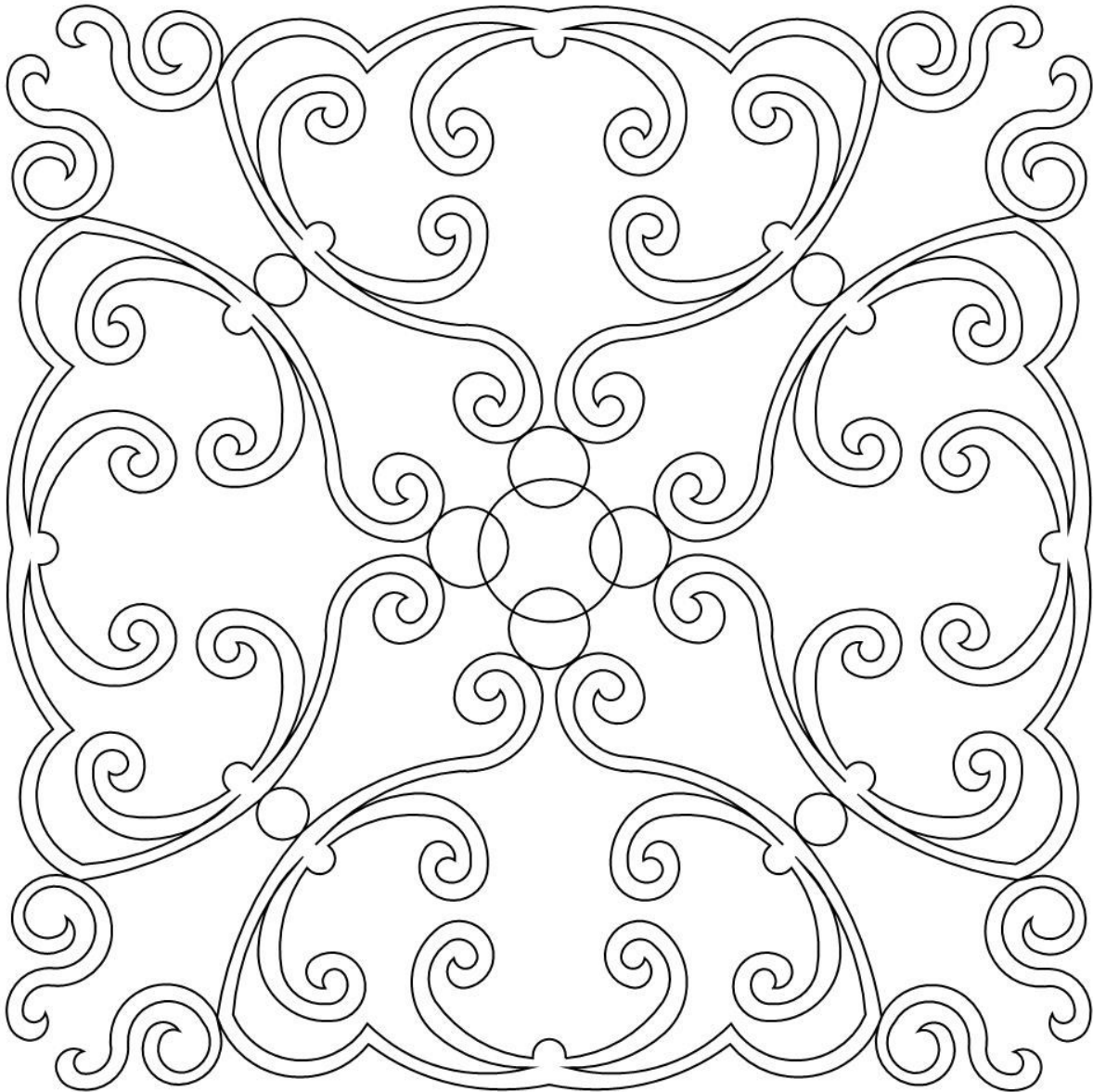

Pattern: passages block 003

Archive: Onyx Earl

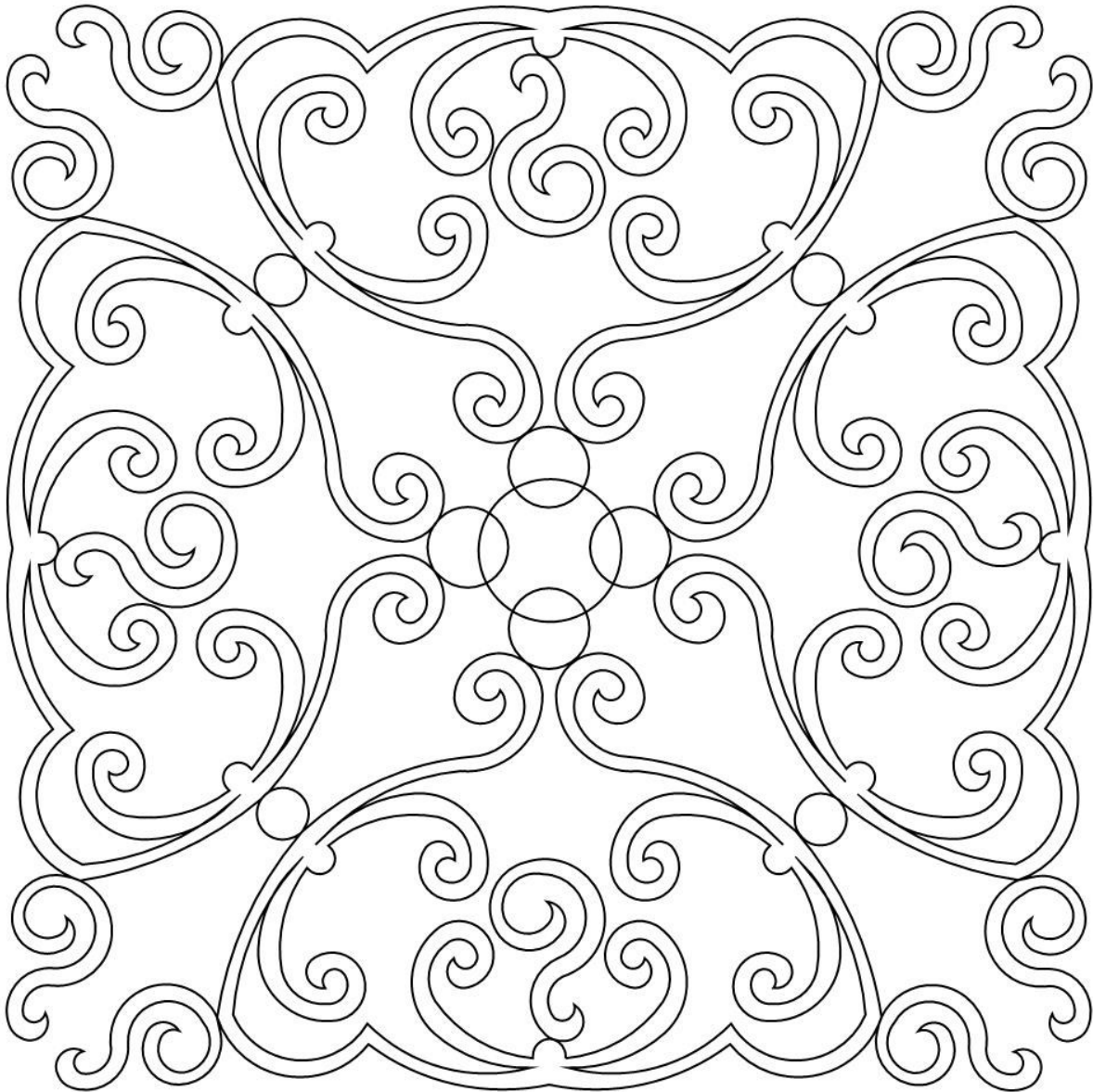

Pattern: passages block 004

Archive: Onyx Earl

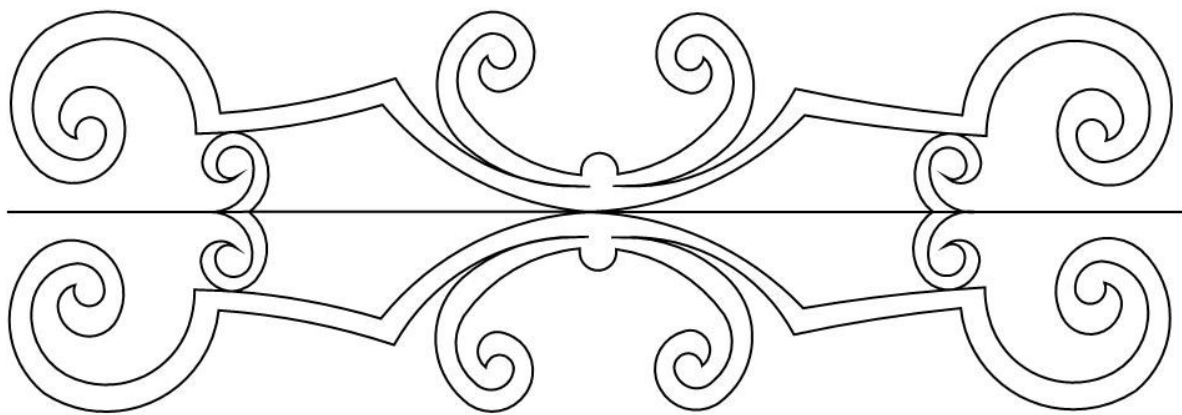

Pattern: passages border 001

Archive: Onyx Earl

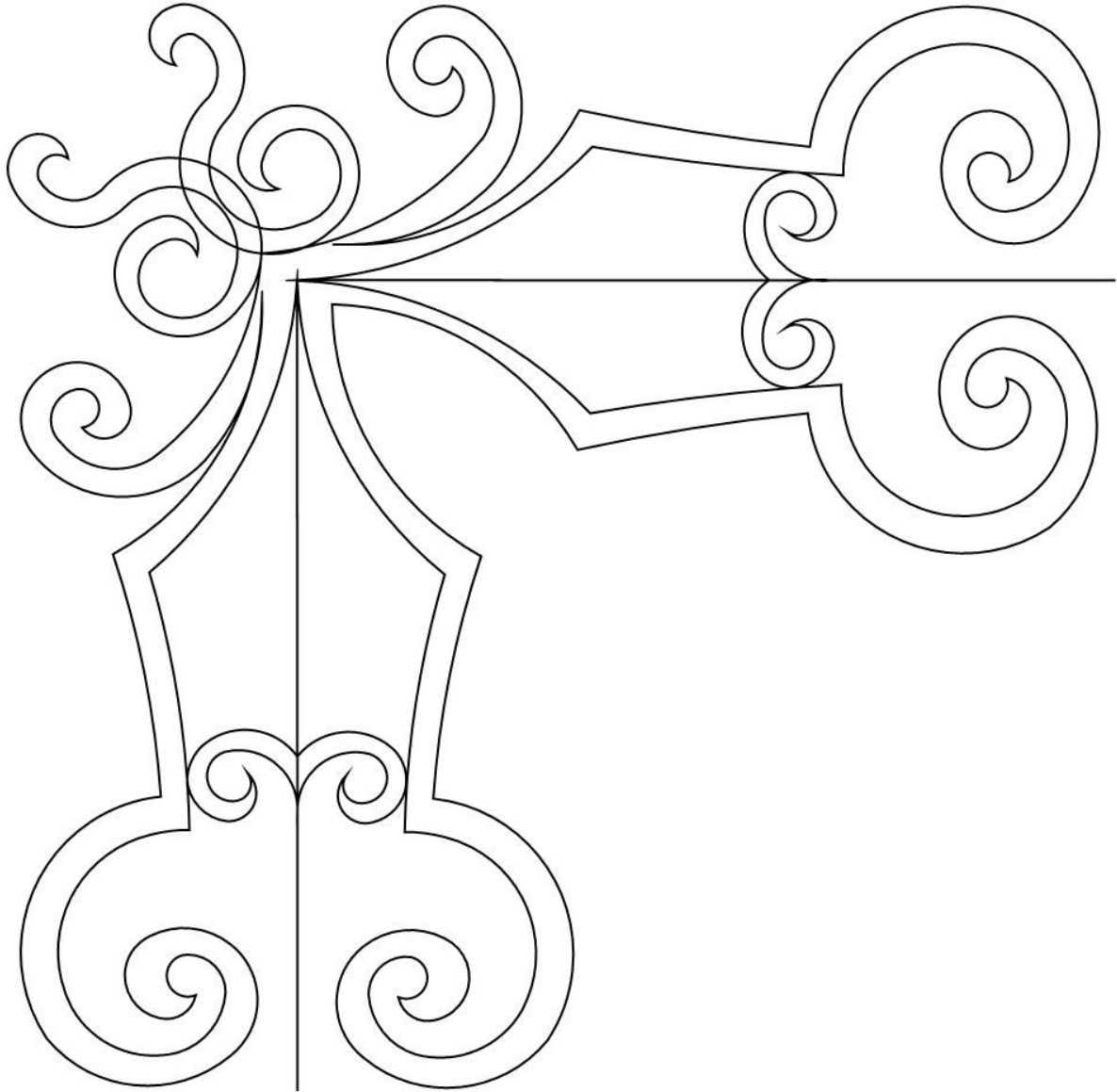

Pattern: passages brd crn 001

Archive: Onyx Earl

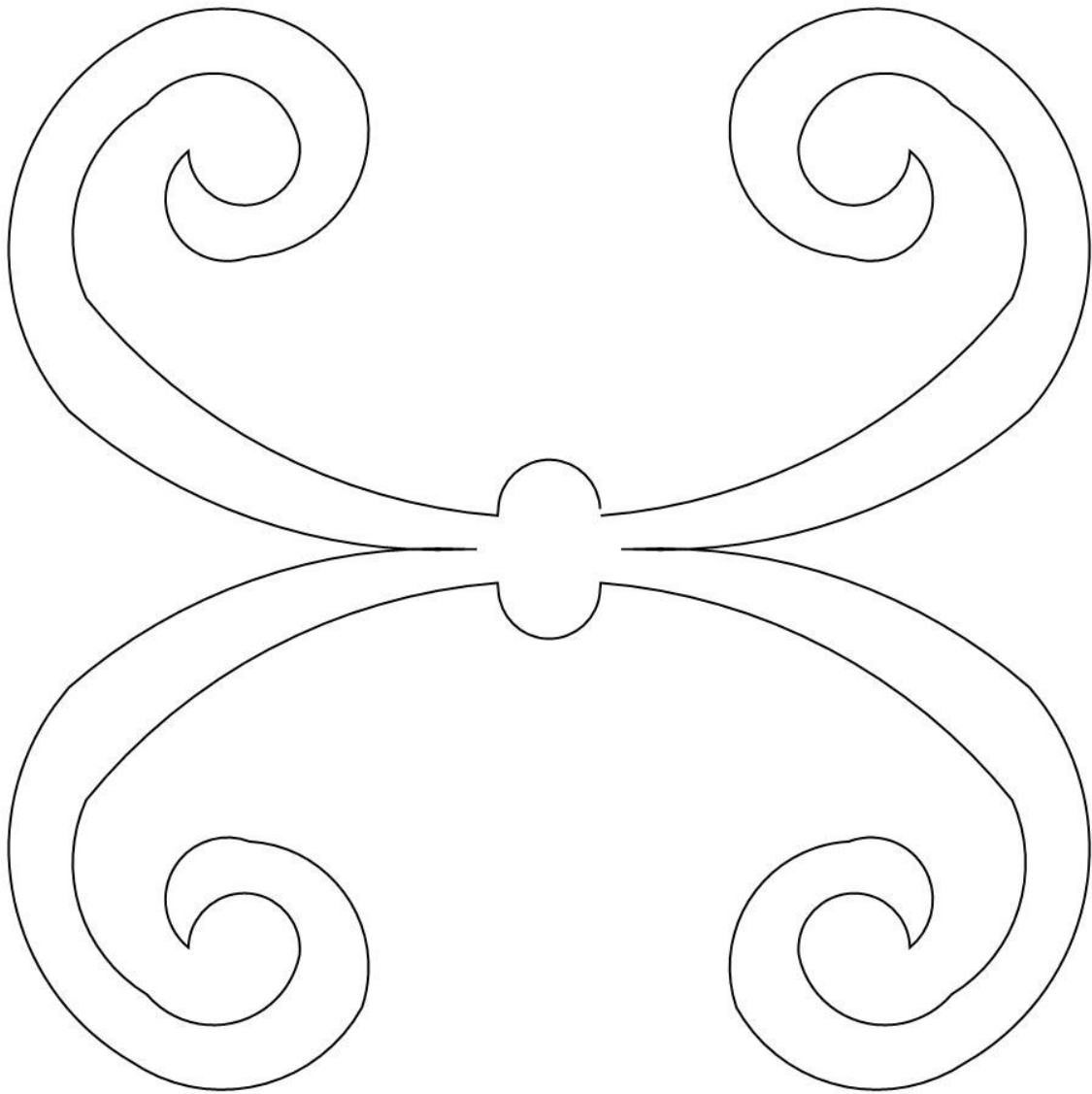

Pattern: passages cornerstone blk 001

Archive: Onyx Earl

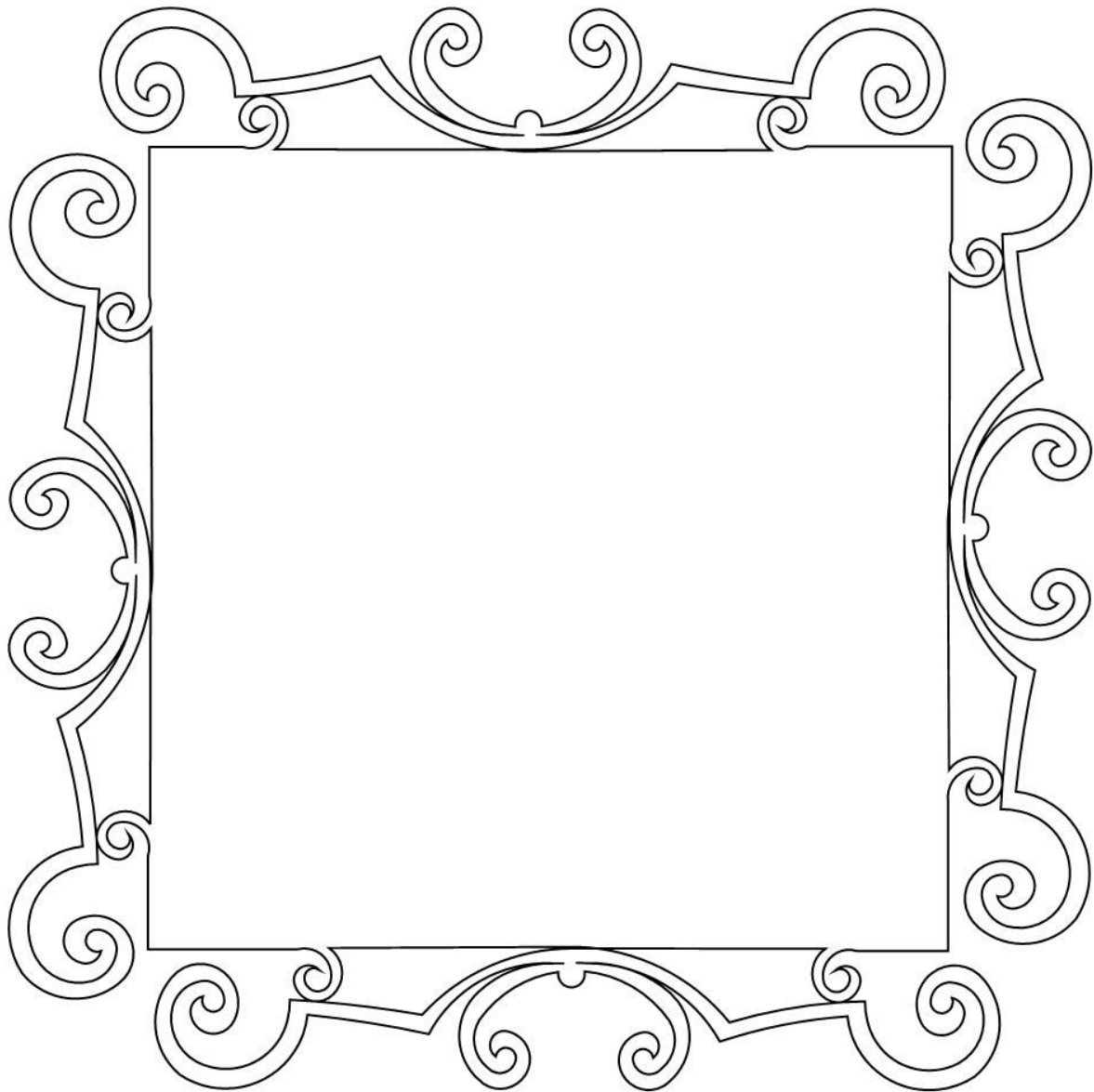

Pattern: passages frame 001

Archive: Onyx Earl

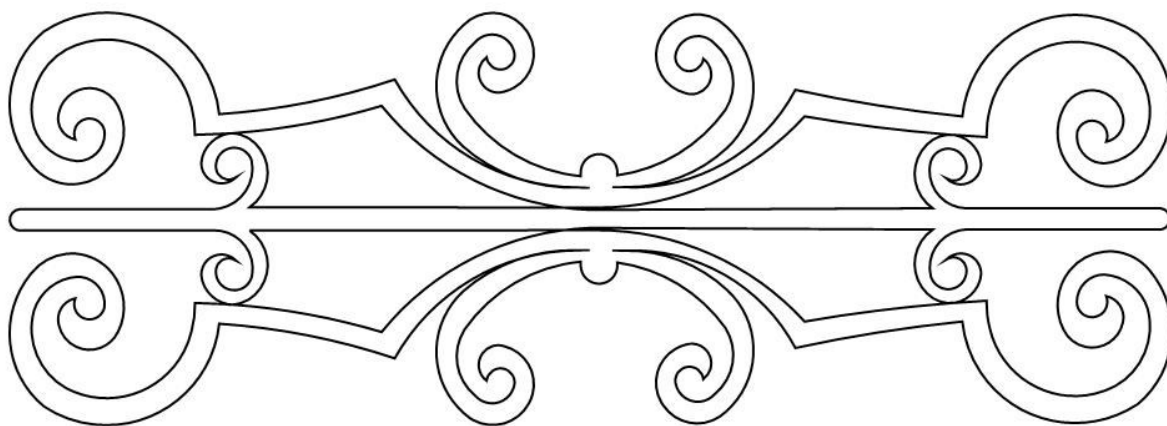

Pattern: passages sash 001

Archive: Onyx Earl

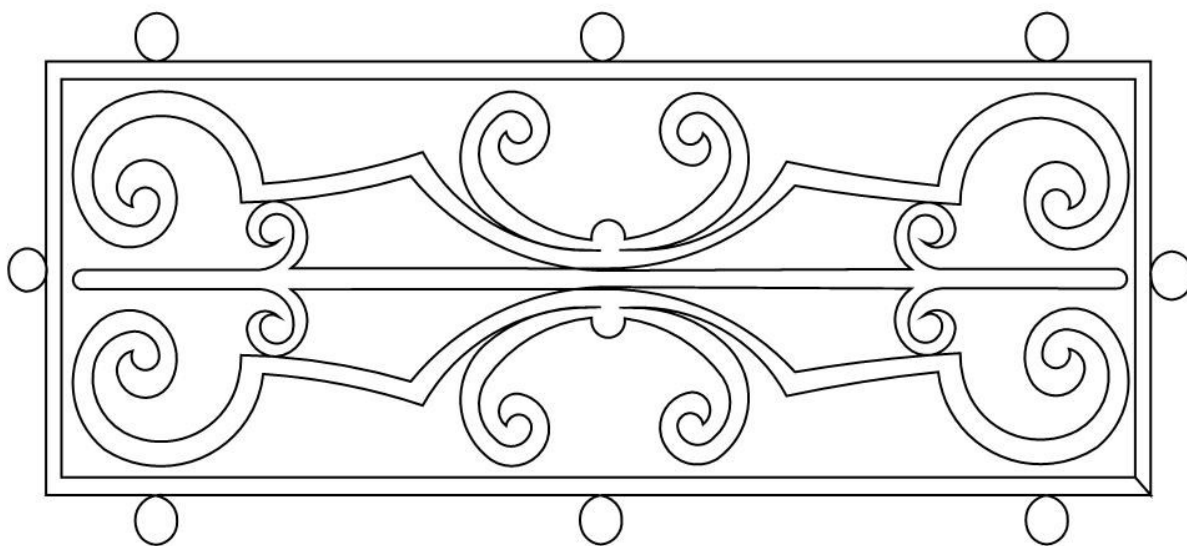

Pattern: passages sash 002

Archive: Onyx Earl

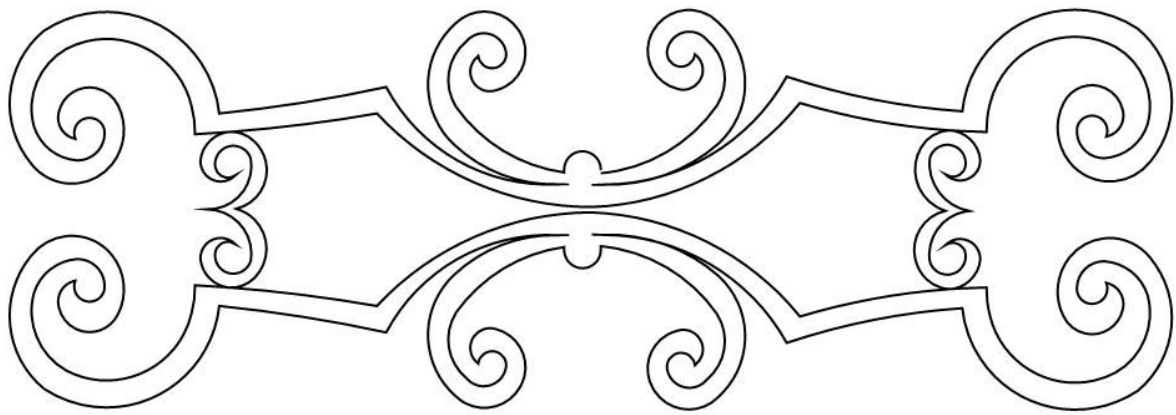

Pattern: passages sash 003

Archive: Onyx Earl

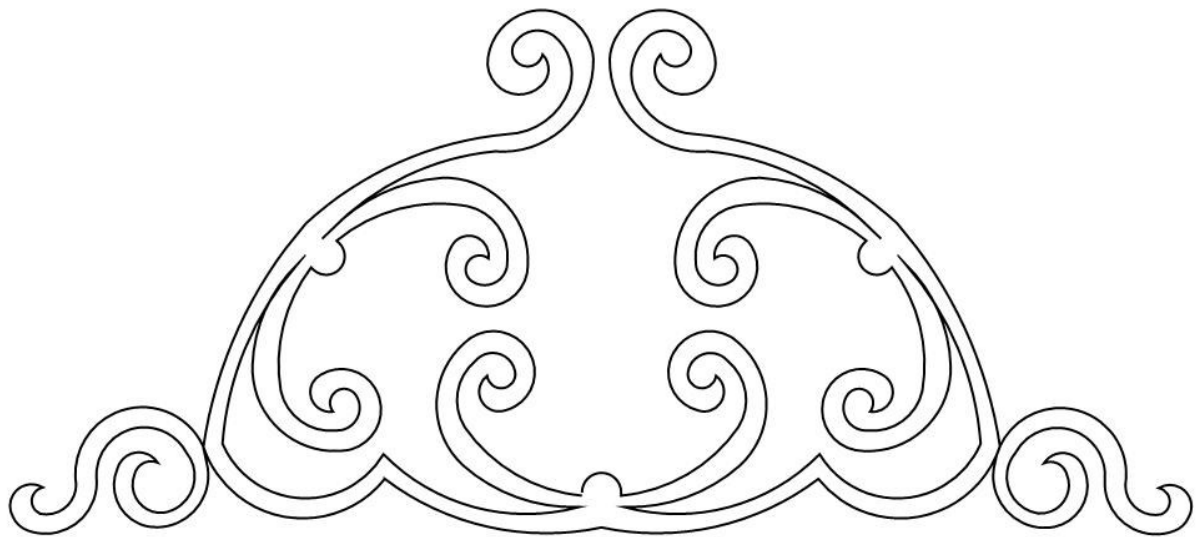

Pattern: passages tri 001

Archive: Onyx Earl

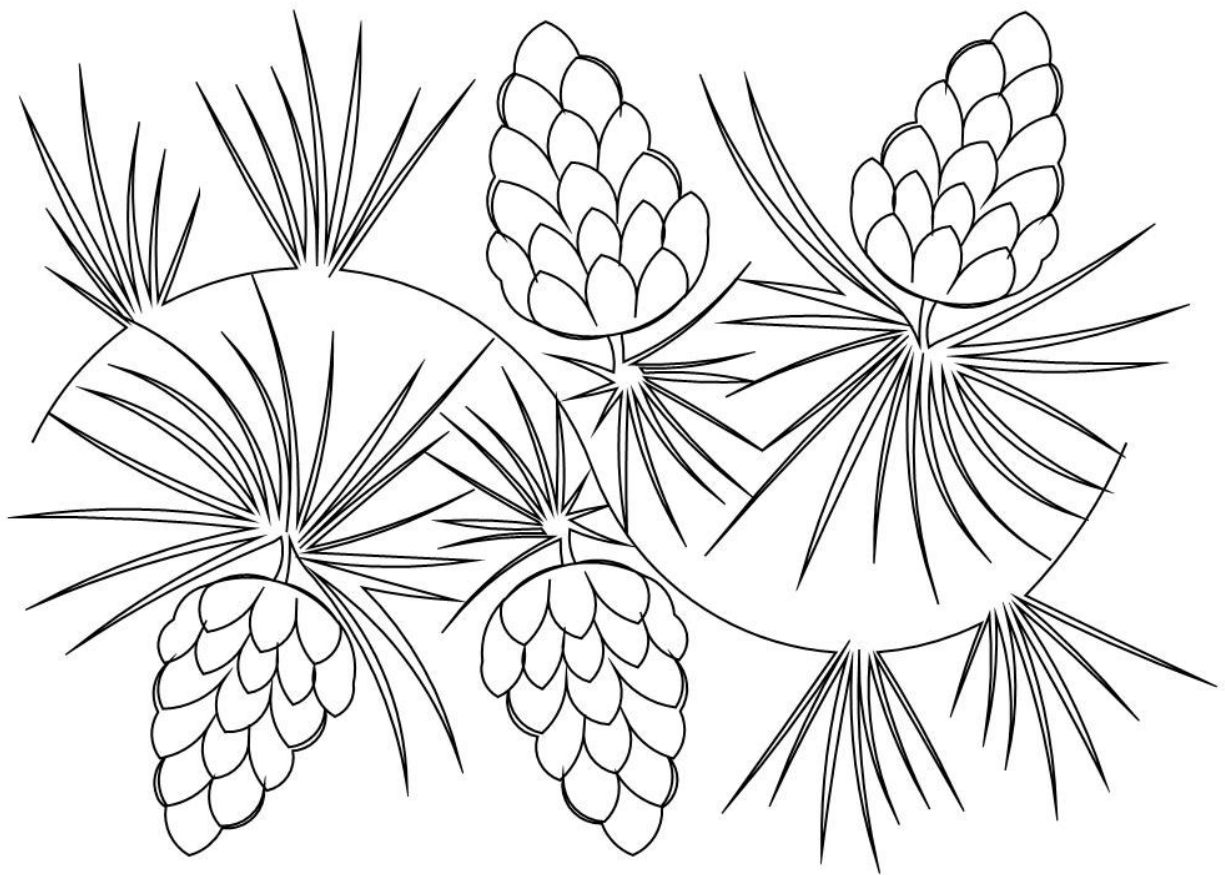

Pattern: pine bough horz border 001

Archive: Onyx Earl

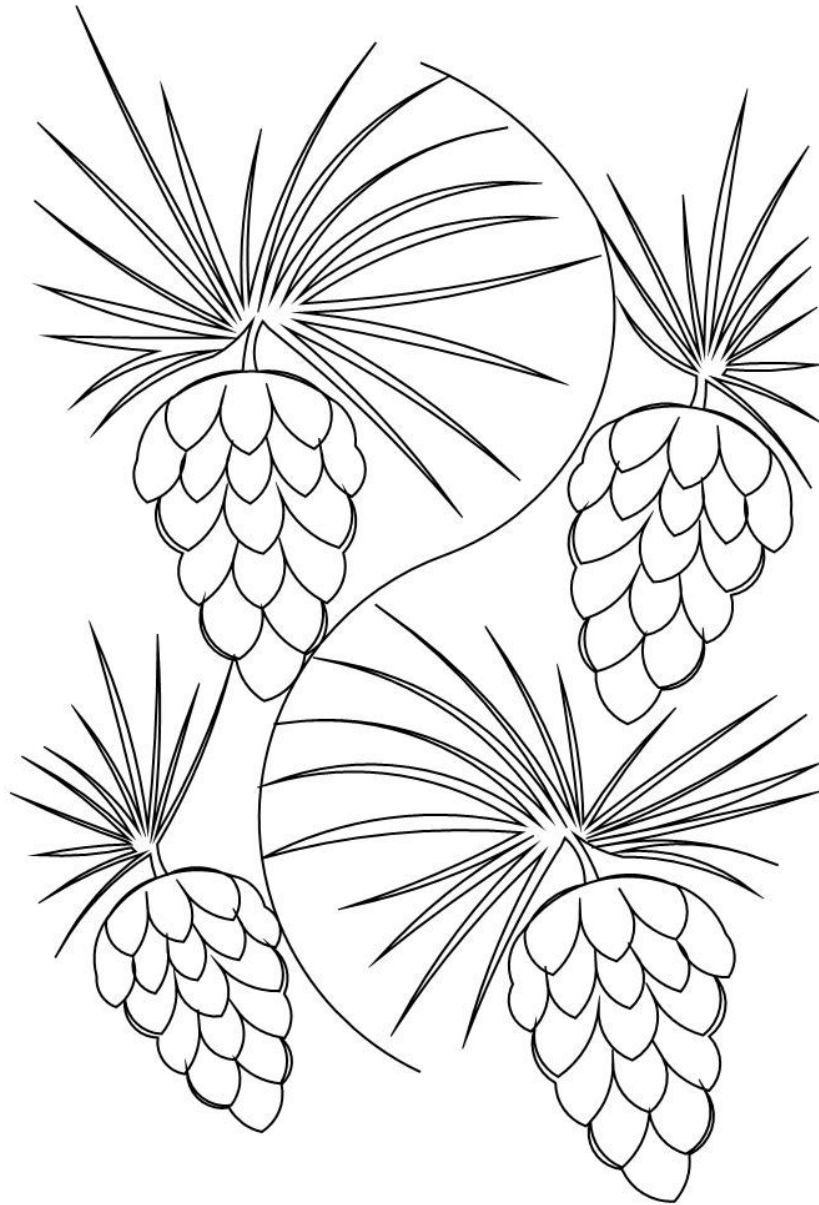

Pattern: pine bough left vert border 001

Archive: Onyx Earl

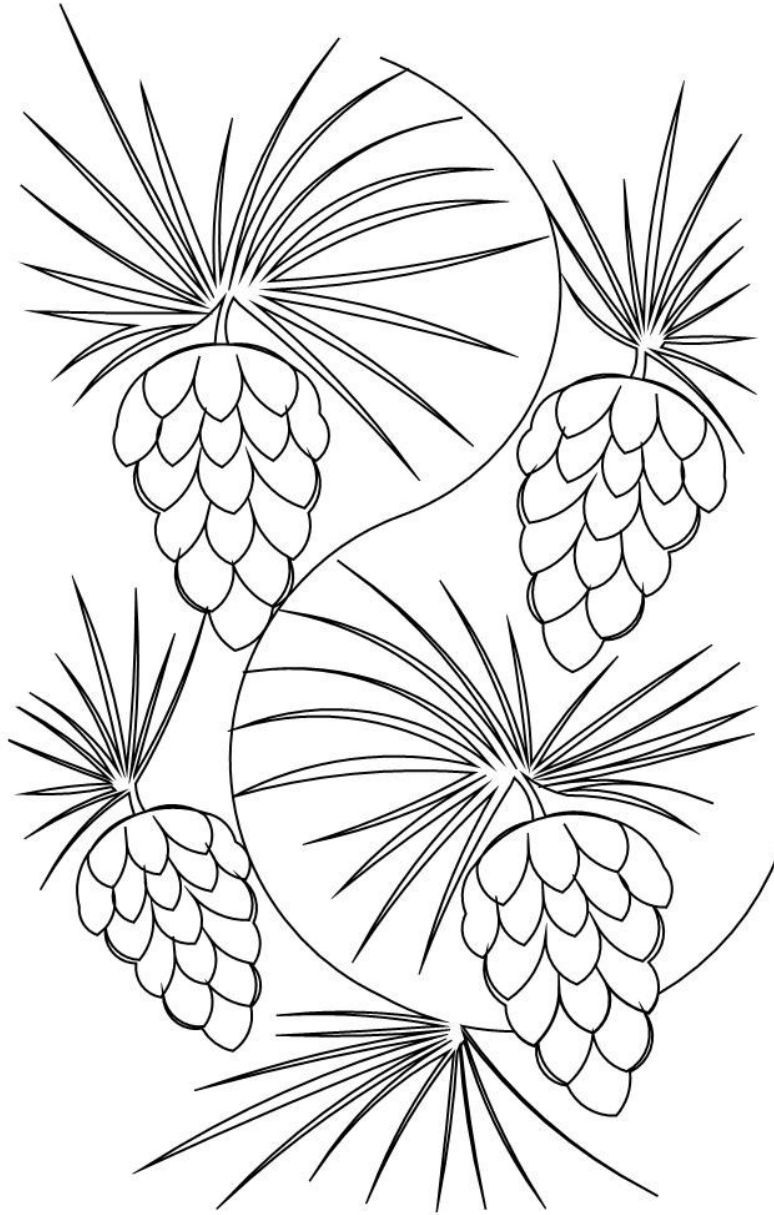

Pattern: pine bough II brd crn 001

Archive: Onyx Earl

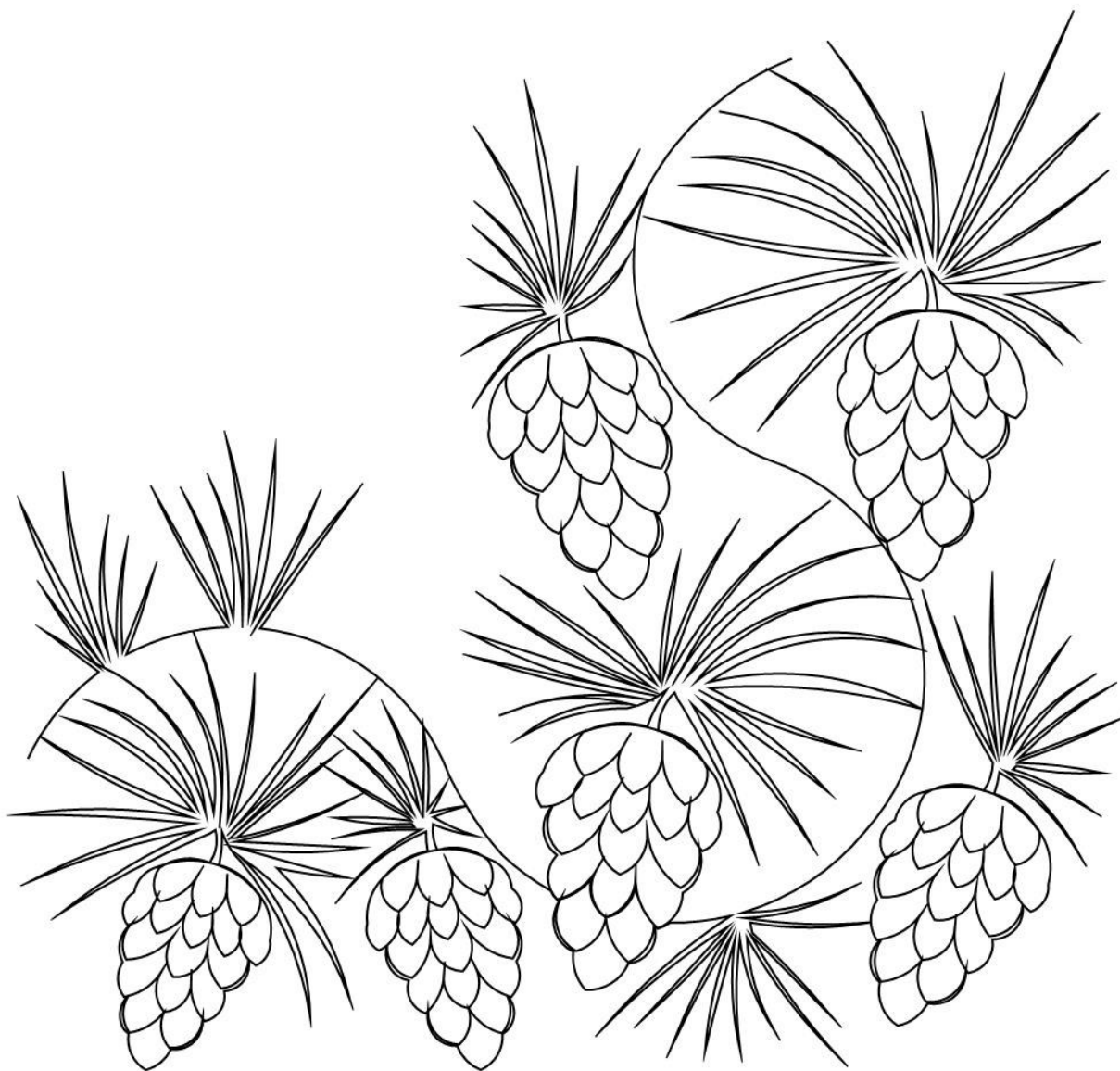

Pattern: pine bough lr brd crn 001

Archive: Onyx Earl

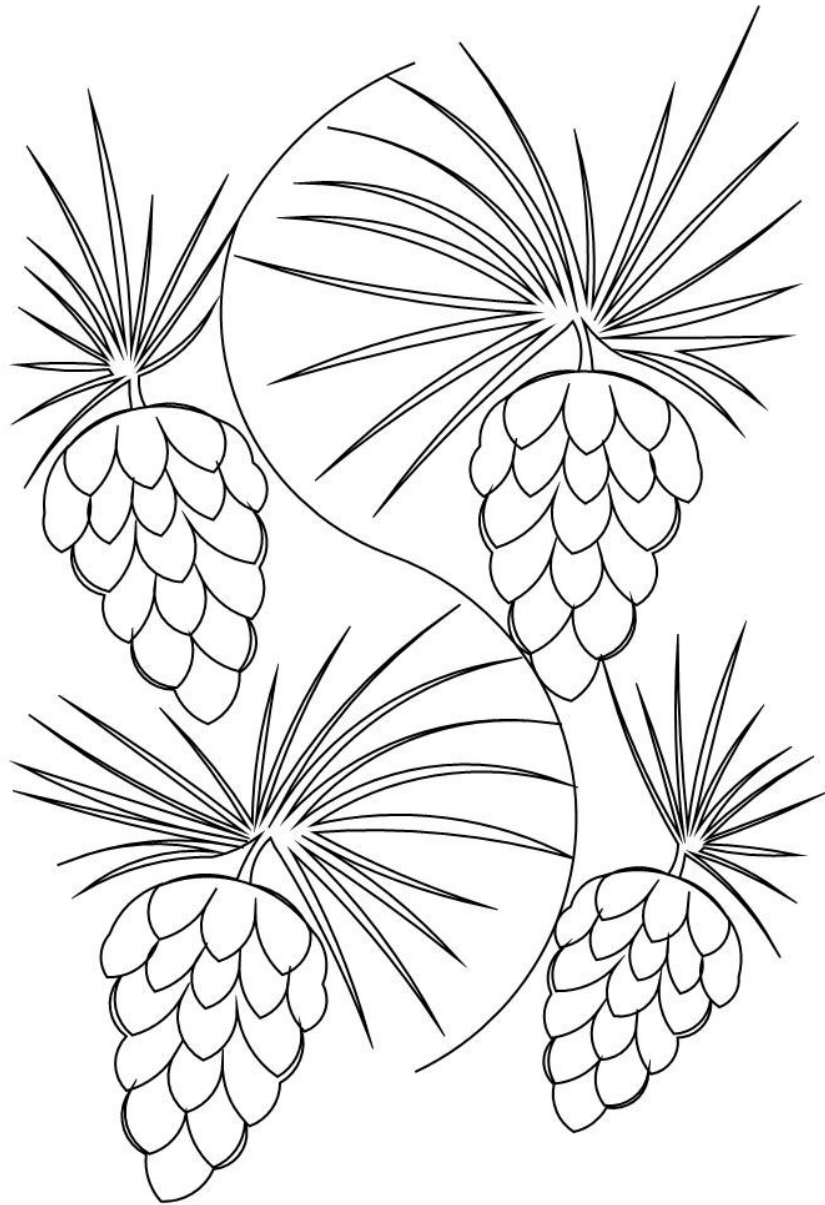

Pattern: pine bough right vert border 001

Archive: Onyx Earl

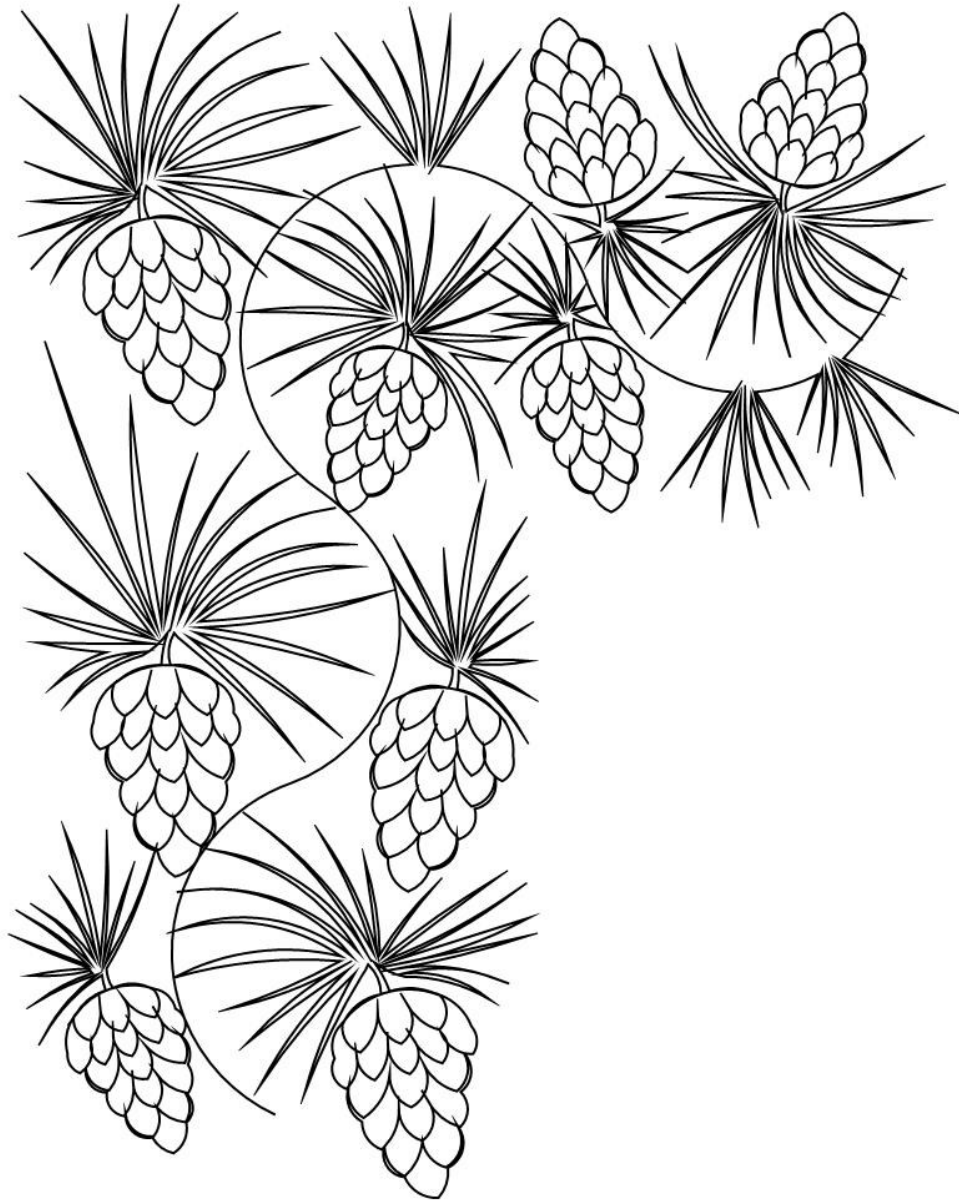

Pattern: pine bough ul brd crn 001

Archive: Onyx Earl



Pattern: pine bough ur brd crn 001

Archive: Onyx Earl

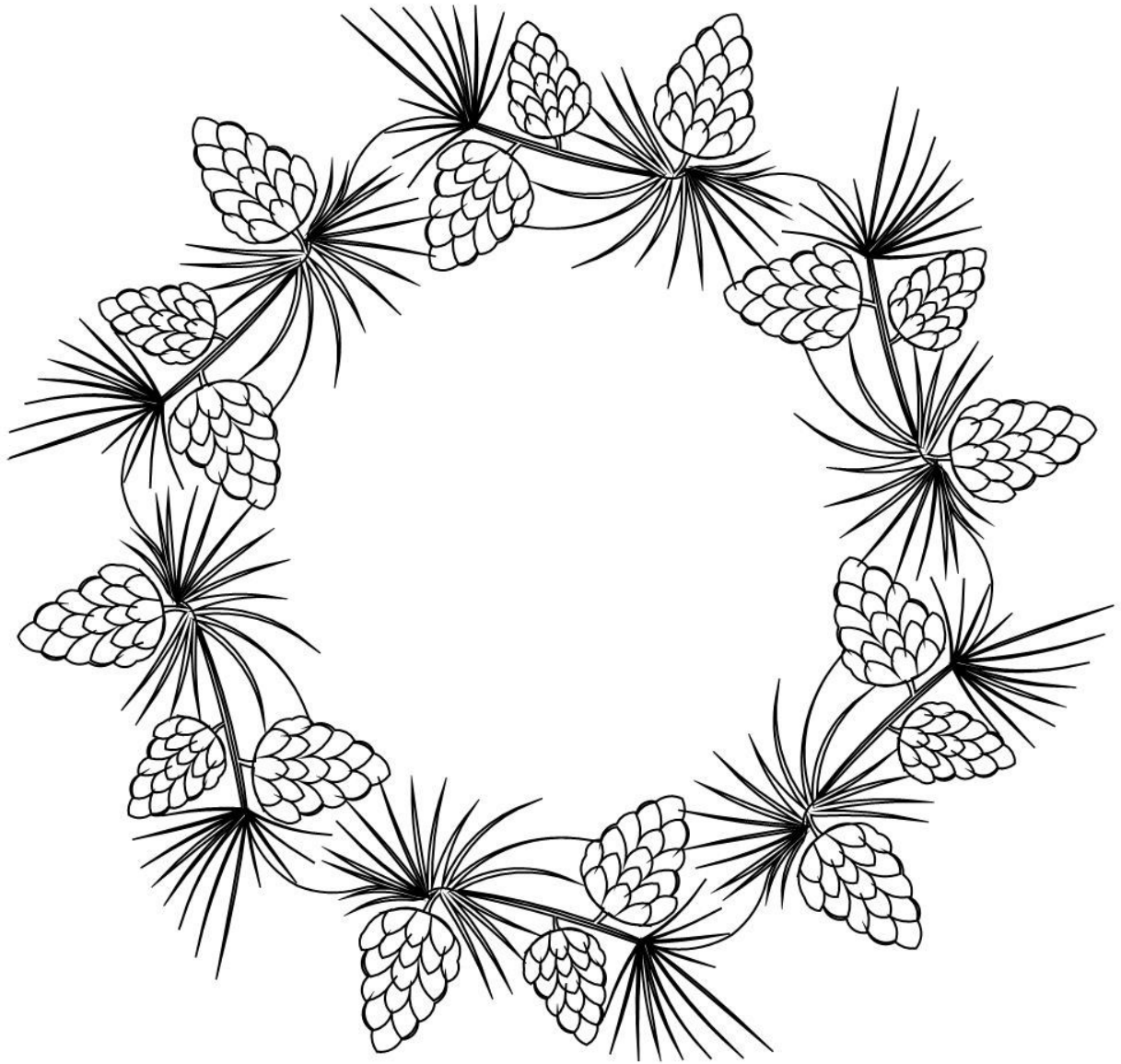

Pattern: pine bough wreath 001

Archive: Onyx Earl



Pattern: route 66 sash 001

Archive: Onyx Earl

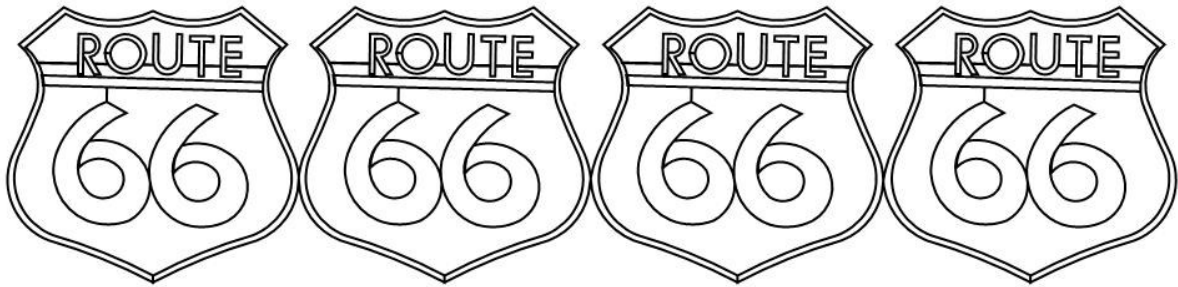

Pattern: route 66 sash 002

Archive: Onyx Earl

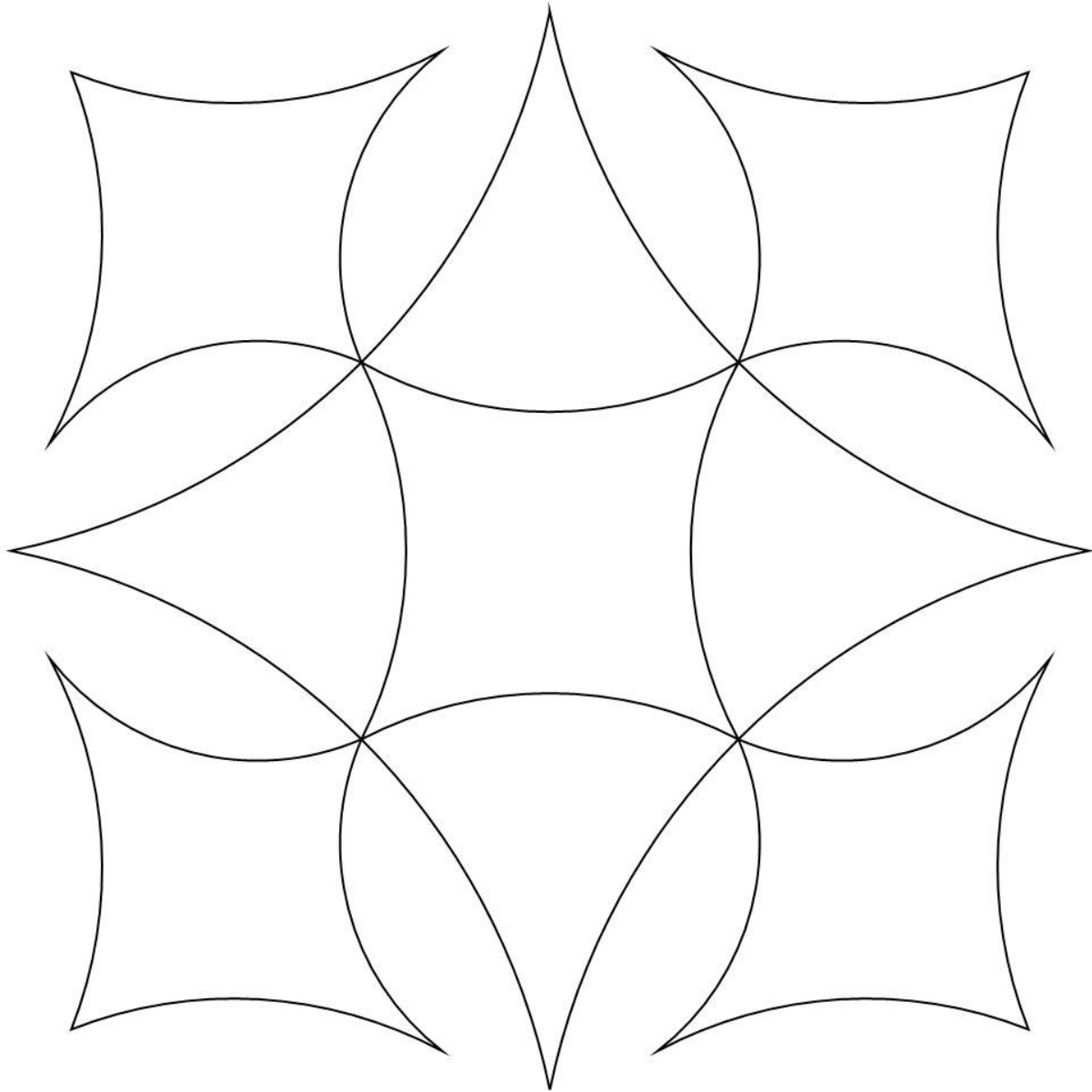

Pattern: storm sash 001

Archive: Onyx Earl

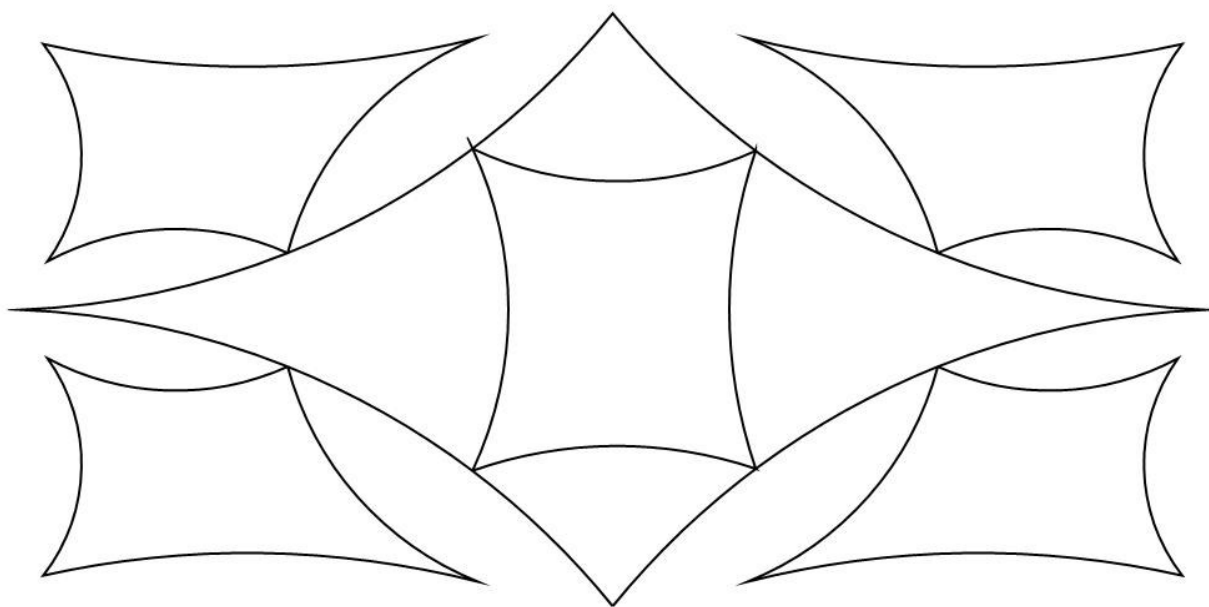

Pattern: storm sash 002

Archive: Onyx Earl

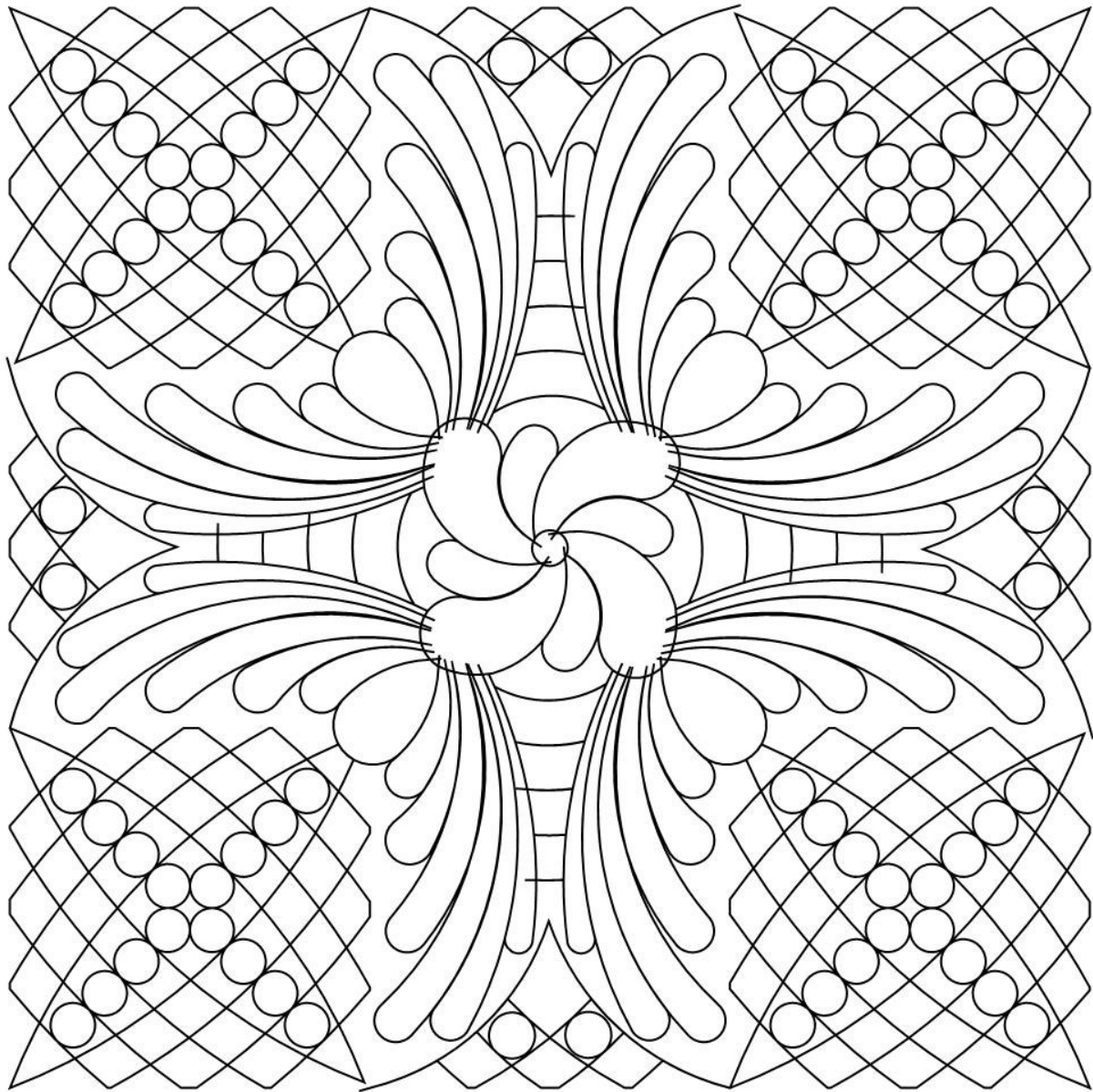

Pattern: sunset block 001

Archive: Onyx Earl

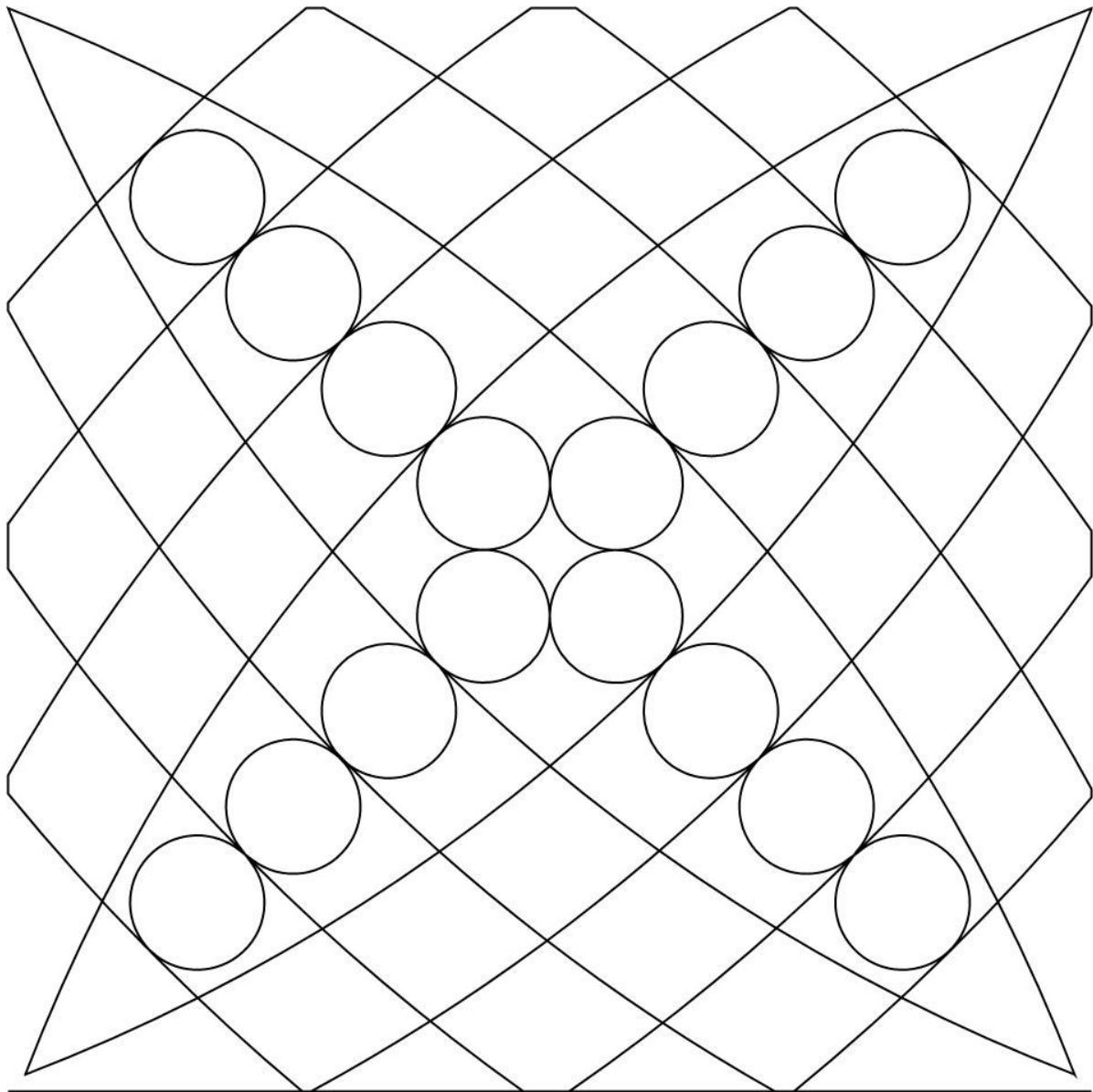

Pattern: sunset p2p 001

Archive: Onyx Earl



Pattern: sunset p2p 002

Archive: Onyx Earl

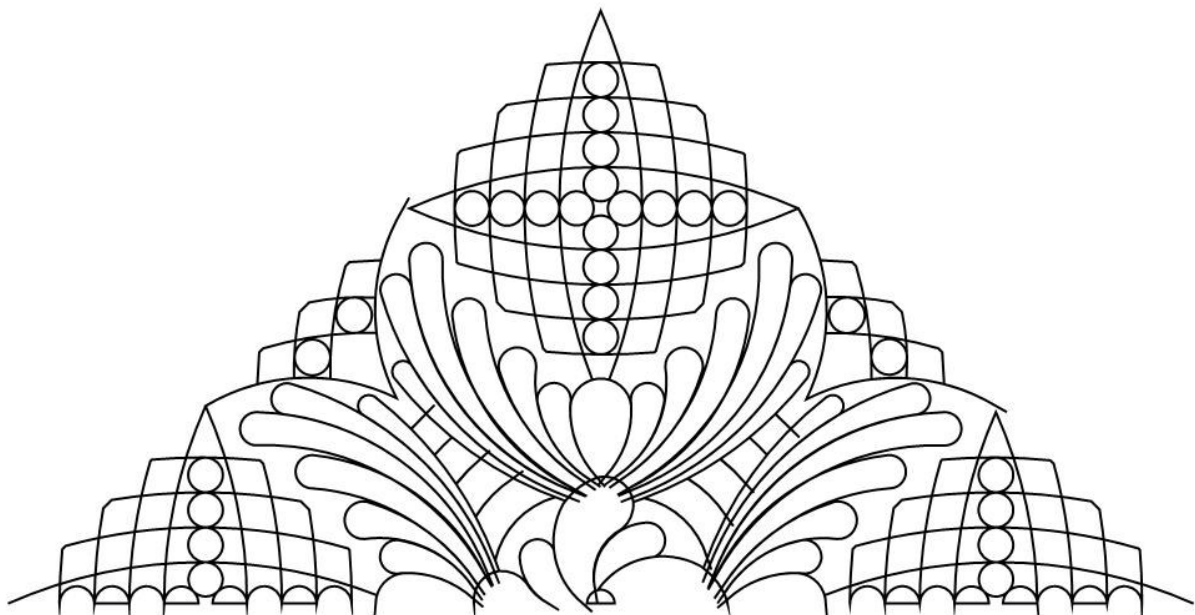

Pattern: sunset tri 001

Archive: Onyx Earl

Venti Chai Nonfat 185 No Water & Plumps No Foam

Pattern: tea bits

Archive: Onyx Earl



Pattern: tea cup pano 001

Archive: Onyx Earl

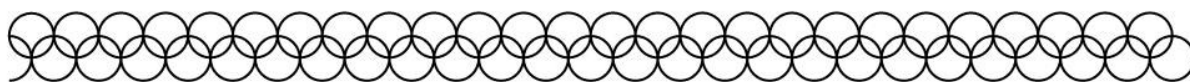

Pattern: tea cup pano 002

Archive: Onyx Earl

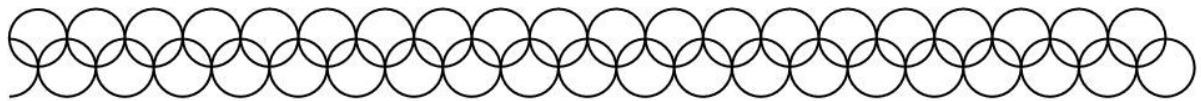

Pattern: tea cup pano 003

Archive: Onyx Earl

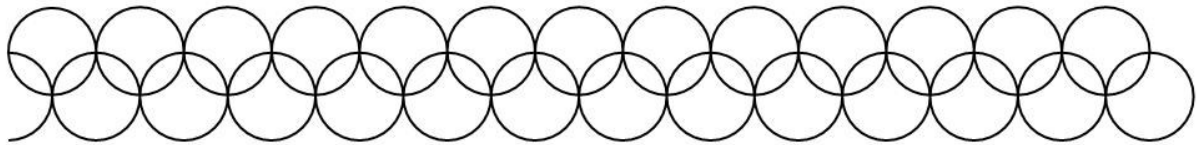

Pattern: tea cup pano 004

Archive: Onyx Earl

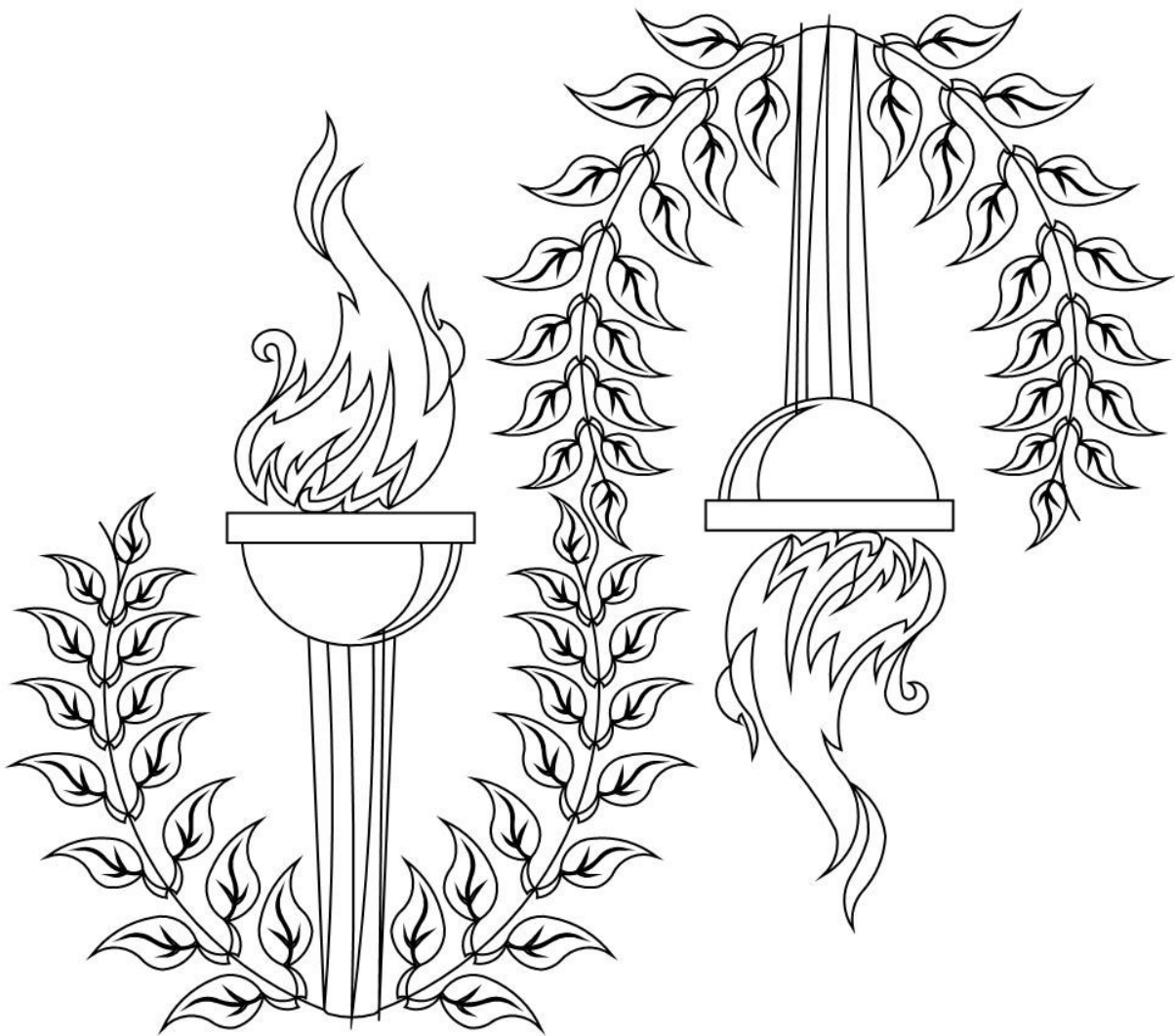

Pattern: torch pano 001

Archive: Onyx Earl

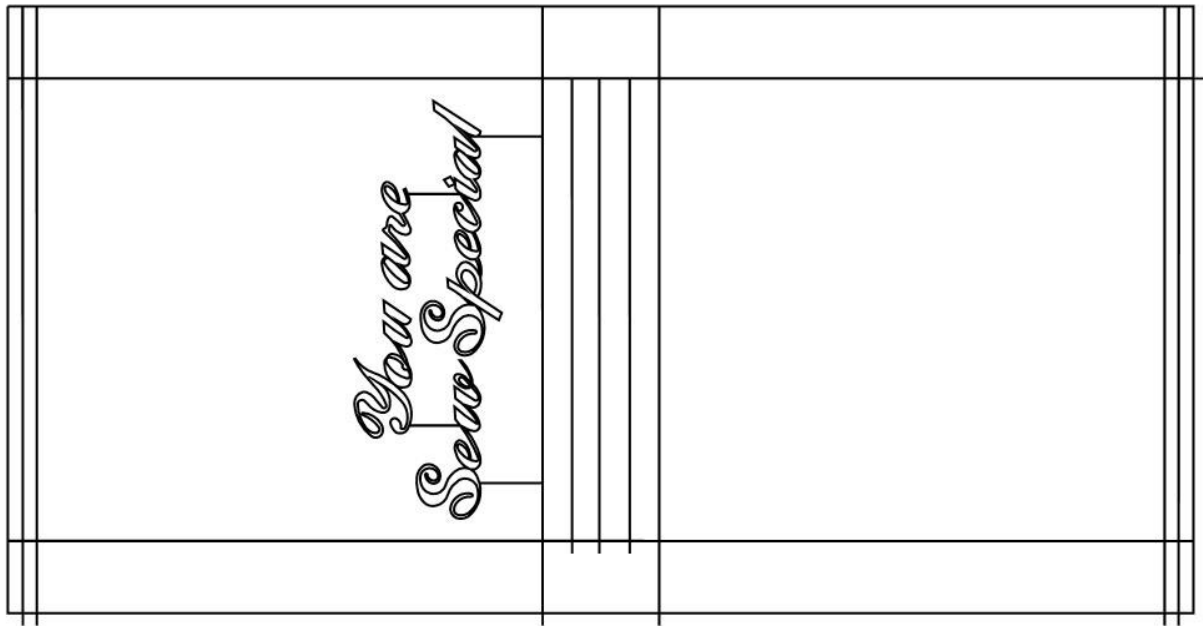

Pattern: tote sew special

Archive: Onyx Earl



Pattern: tweet hex 001

Archive: Onyx Earl

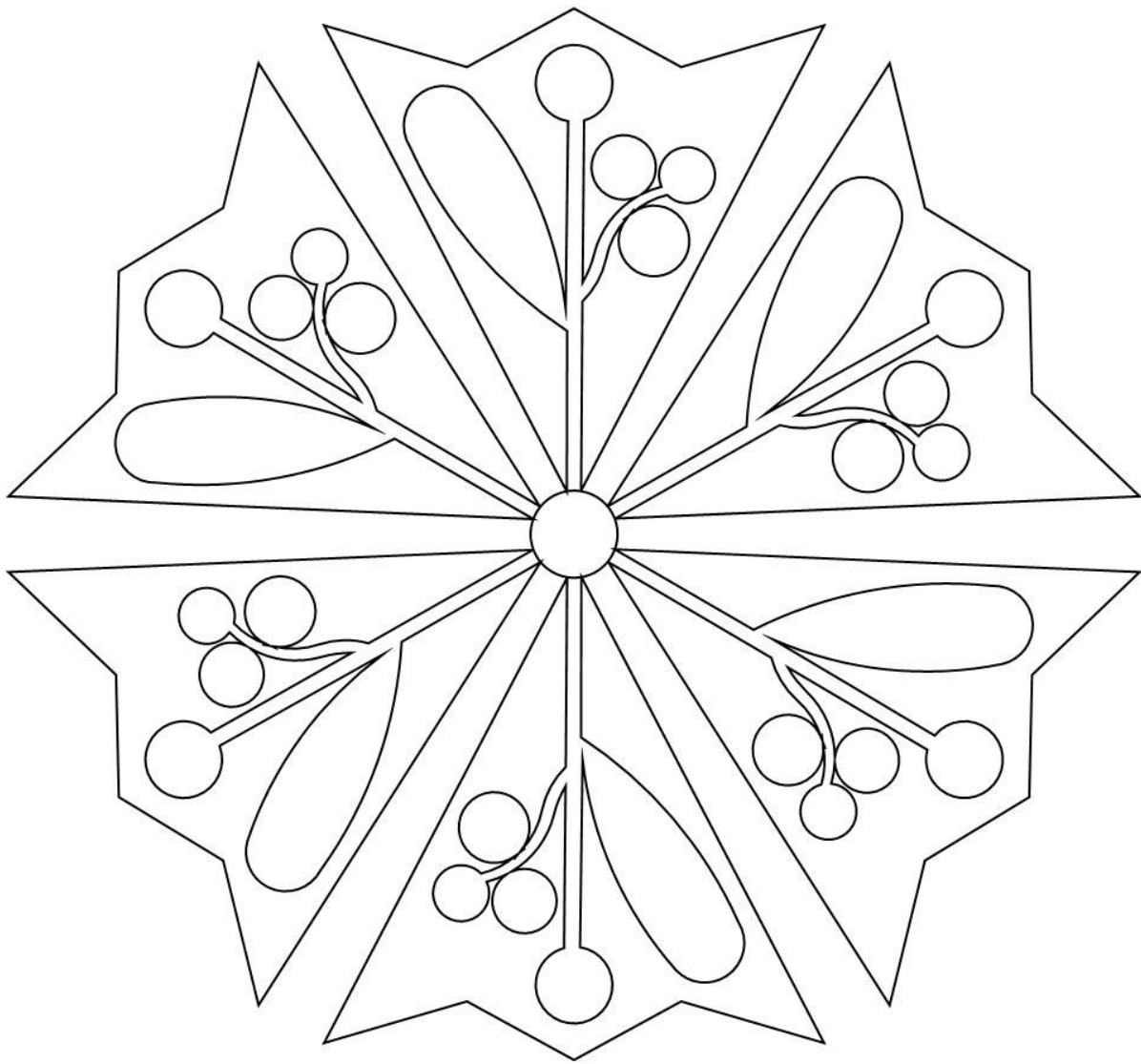

Pattern: tweet hex 002

Archive: Onyx Earl

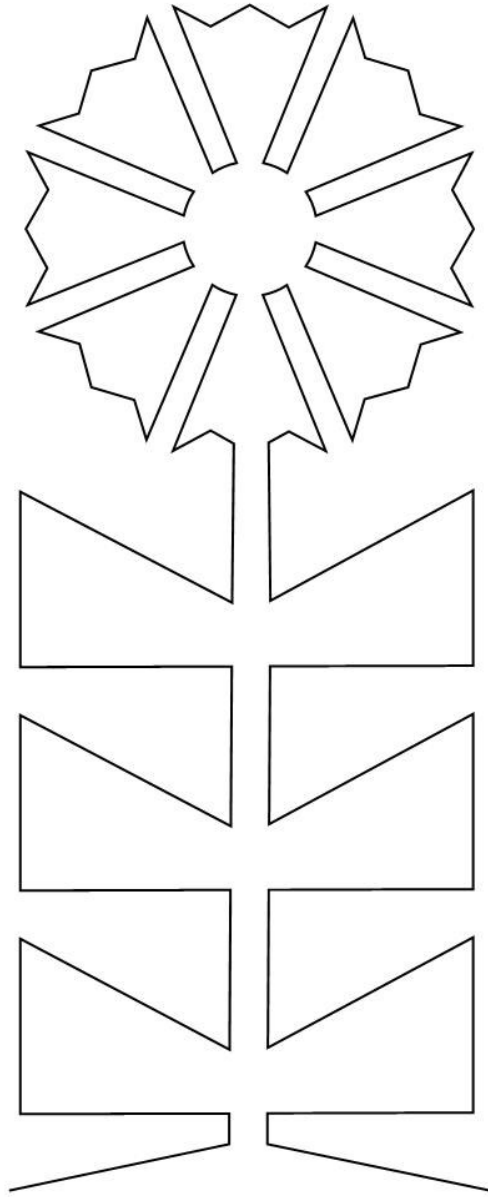

Pattern: tweet p2p 001

Archive: Onyx Earl

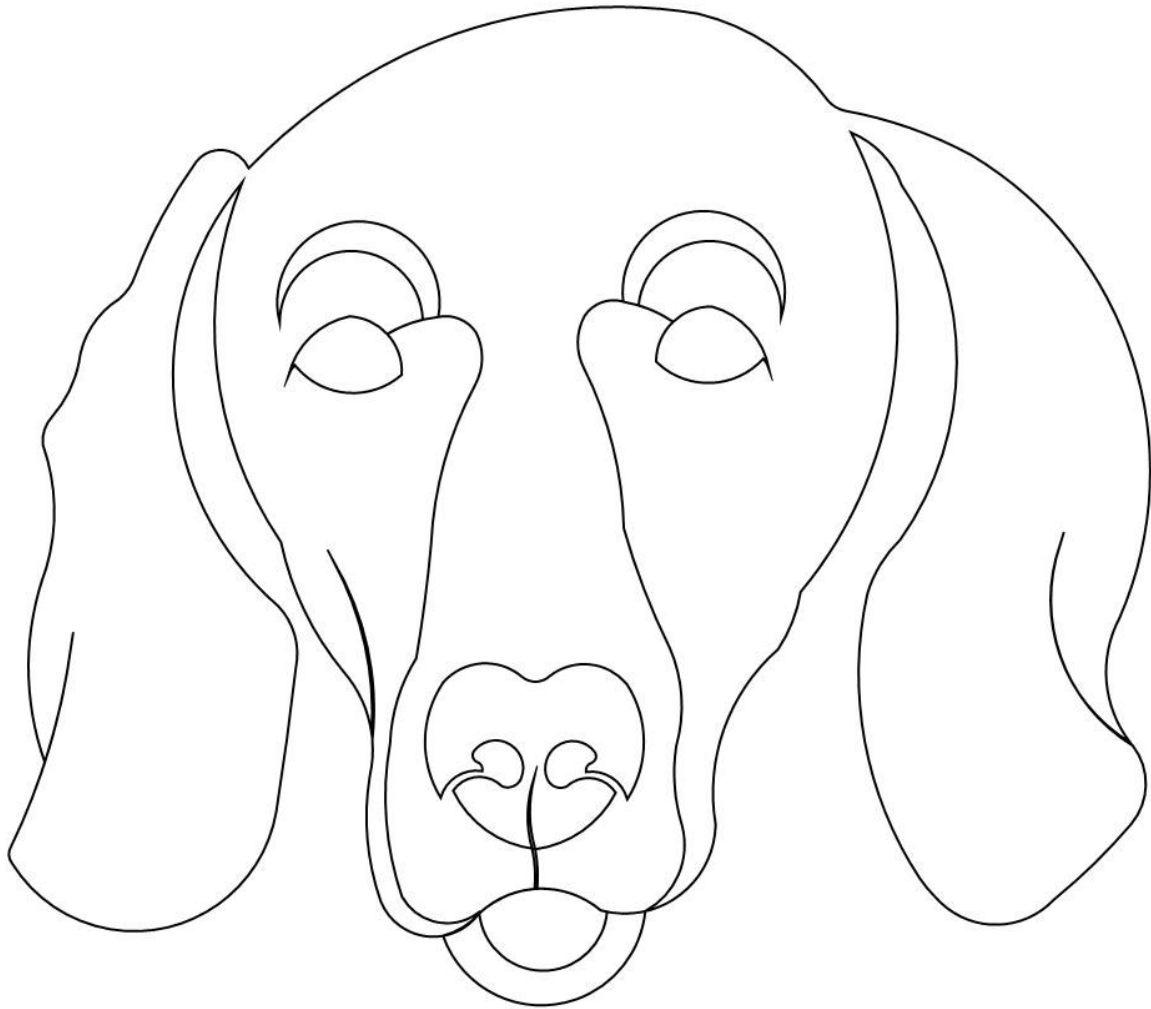

Pattern: weimer block 001

Archive: Onyx Earl

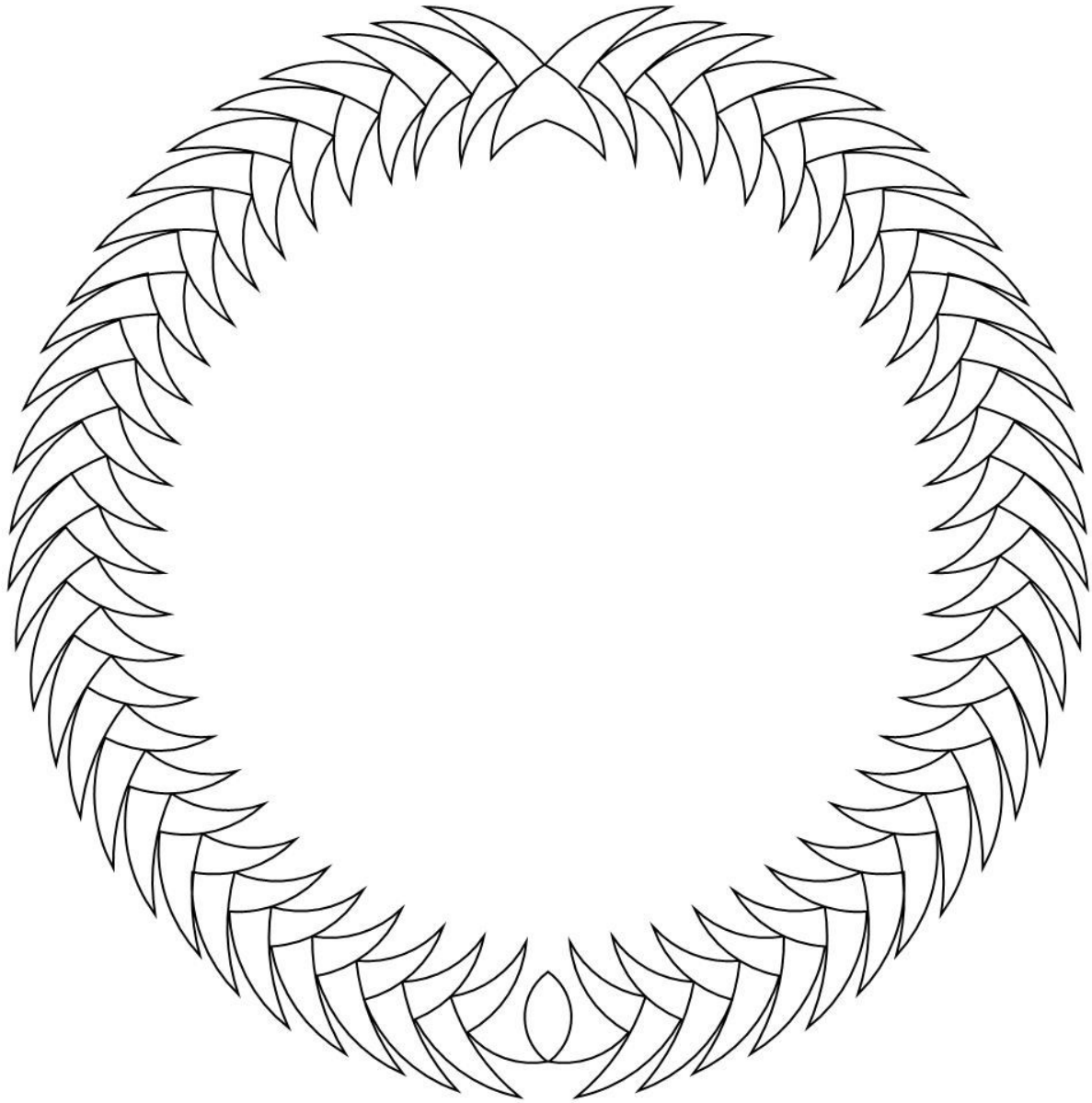

Pattern: wreath 001

Archive: Onyx Earl

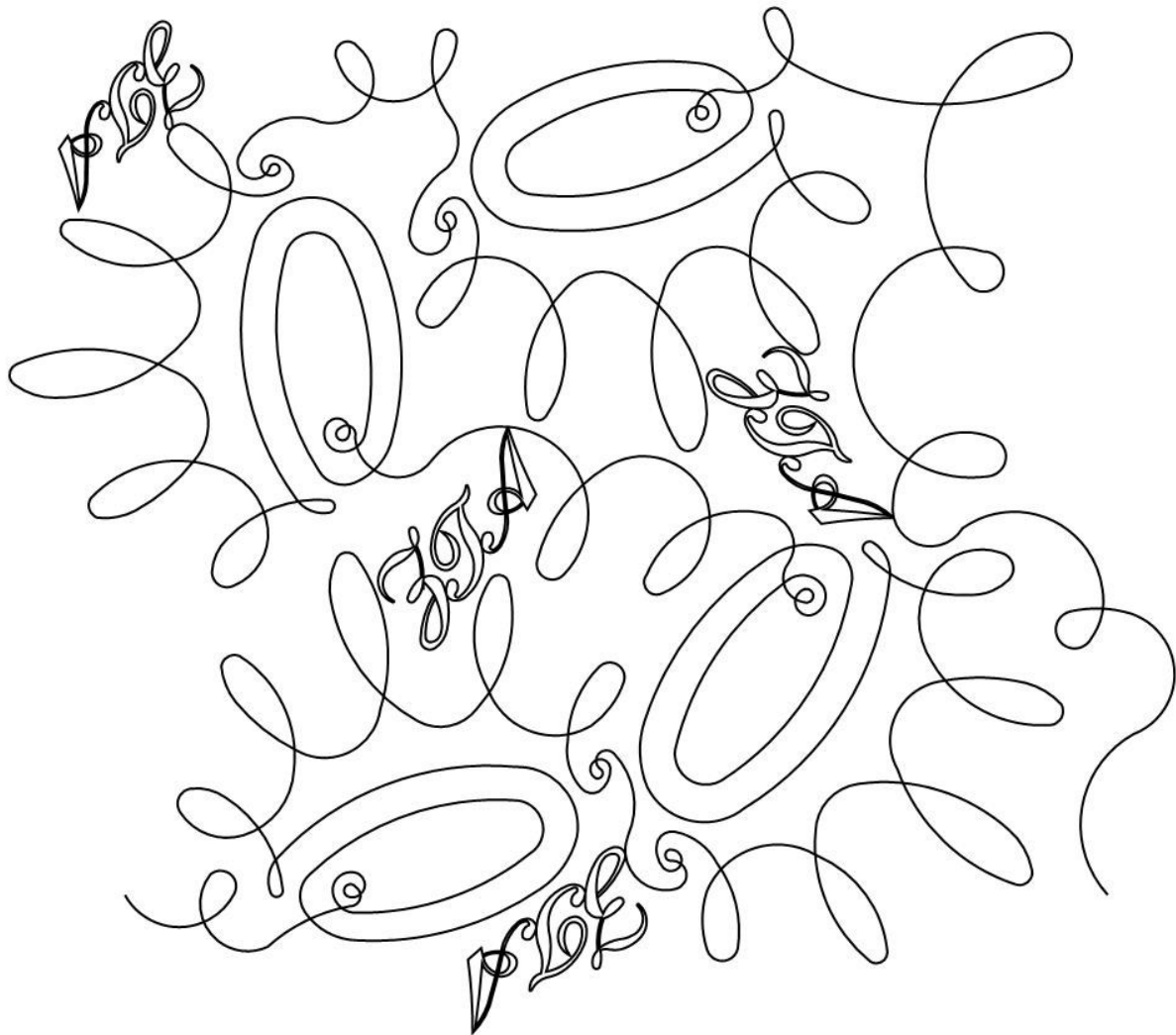

Pattern: zta crown pano 001

Archive: Onyx Earl