

Pattern: 60 degree diamond outline

Archive: Quartz September 2015

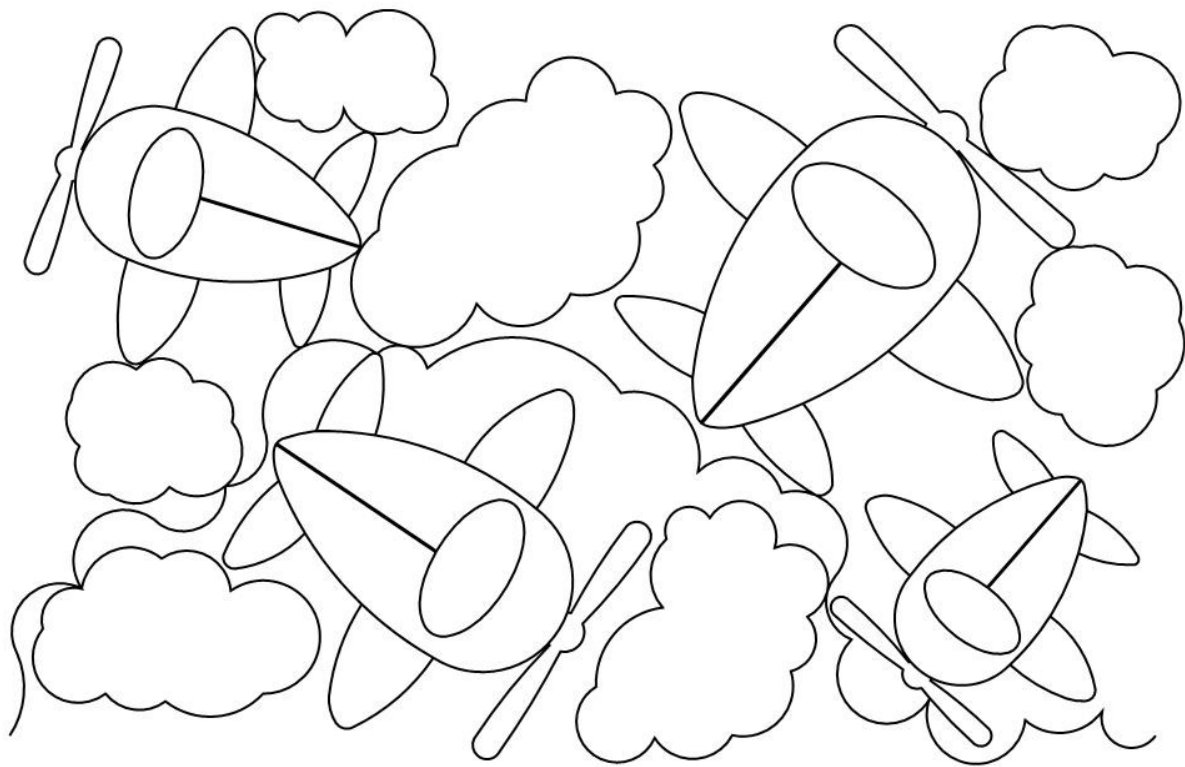

Pattern: airplane pano kid 001

Archive: Quartz September 2015

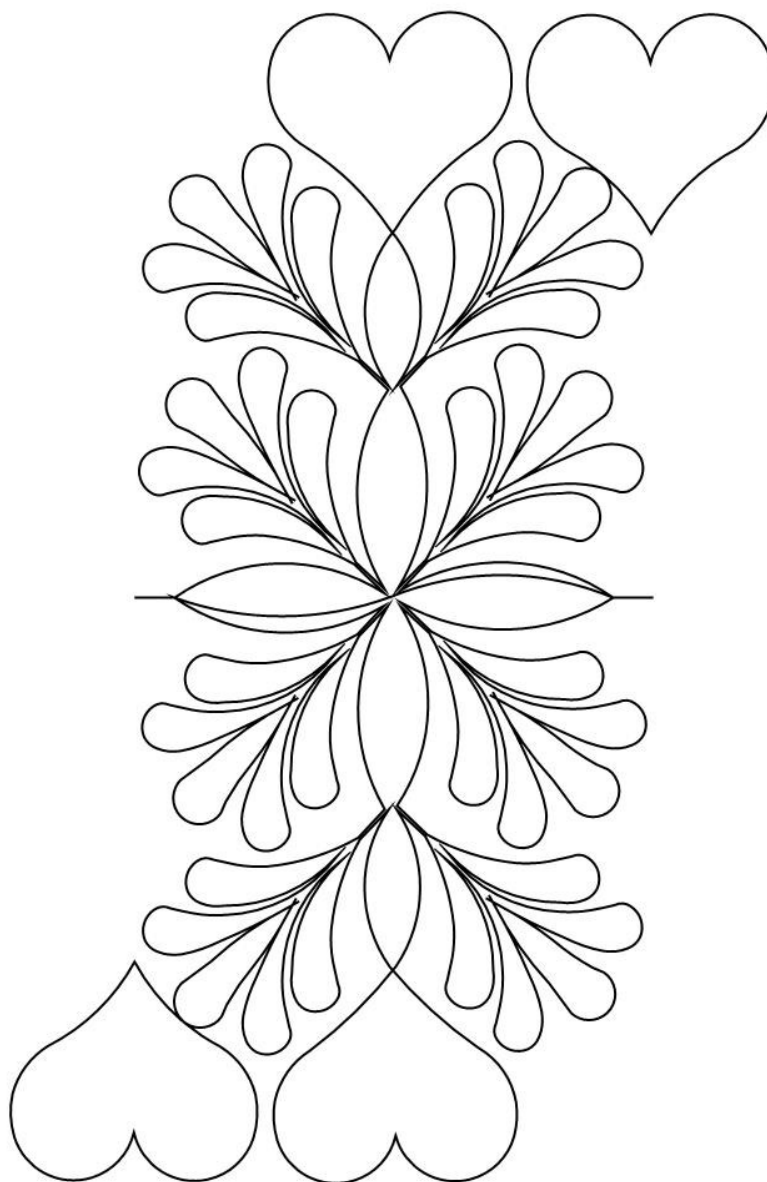

Pattern: allissa border 003

Archive: Quartz September 2015

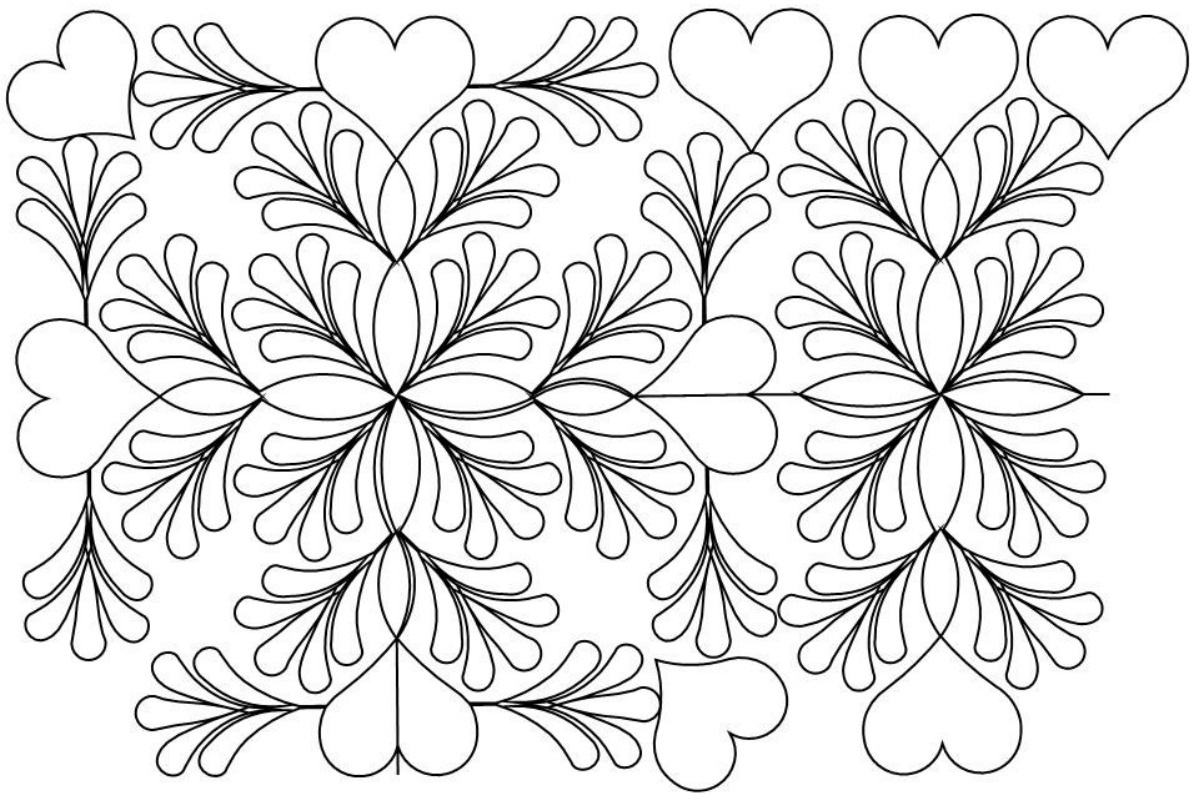

Pattern: allissa brd crn 003

Archive: Quartz September 2015

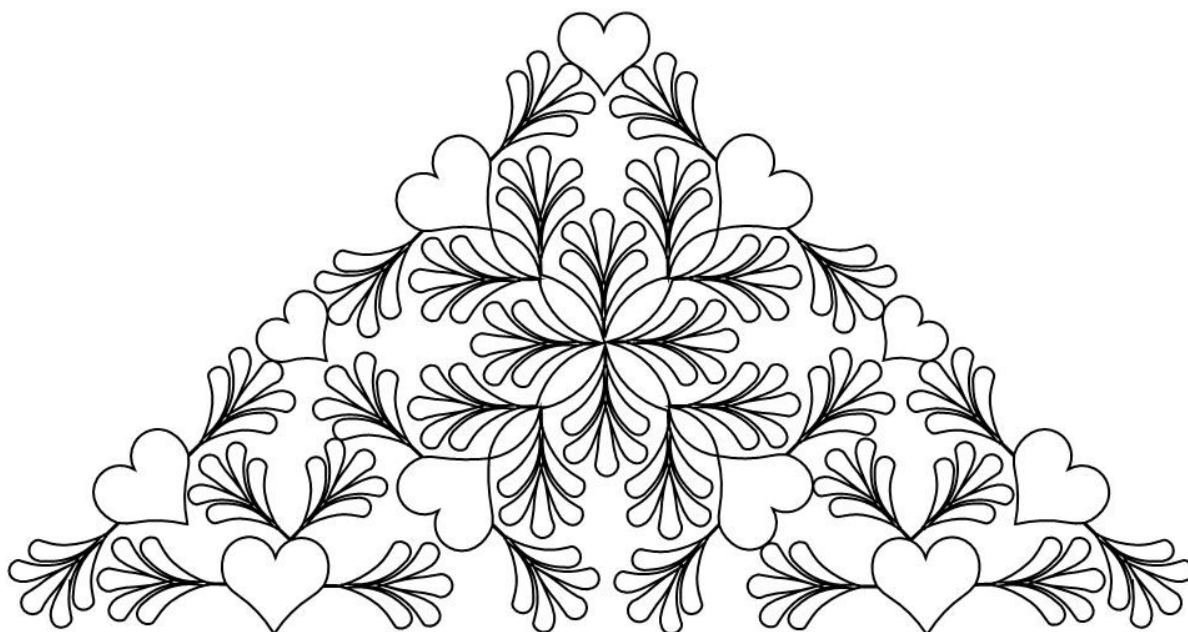

Pattern: allissa set tri 001

Archive: Quartz September 2015

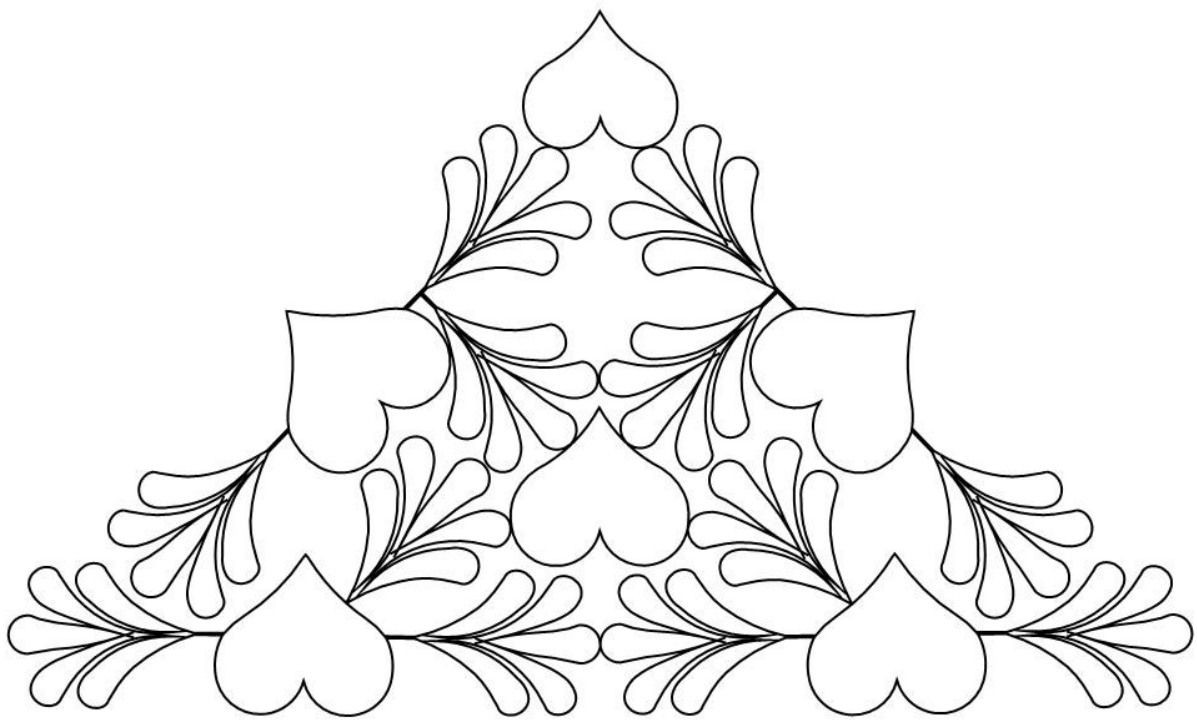

Pattern: allissa set tri 002

Archive: Quartz September 2015

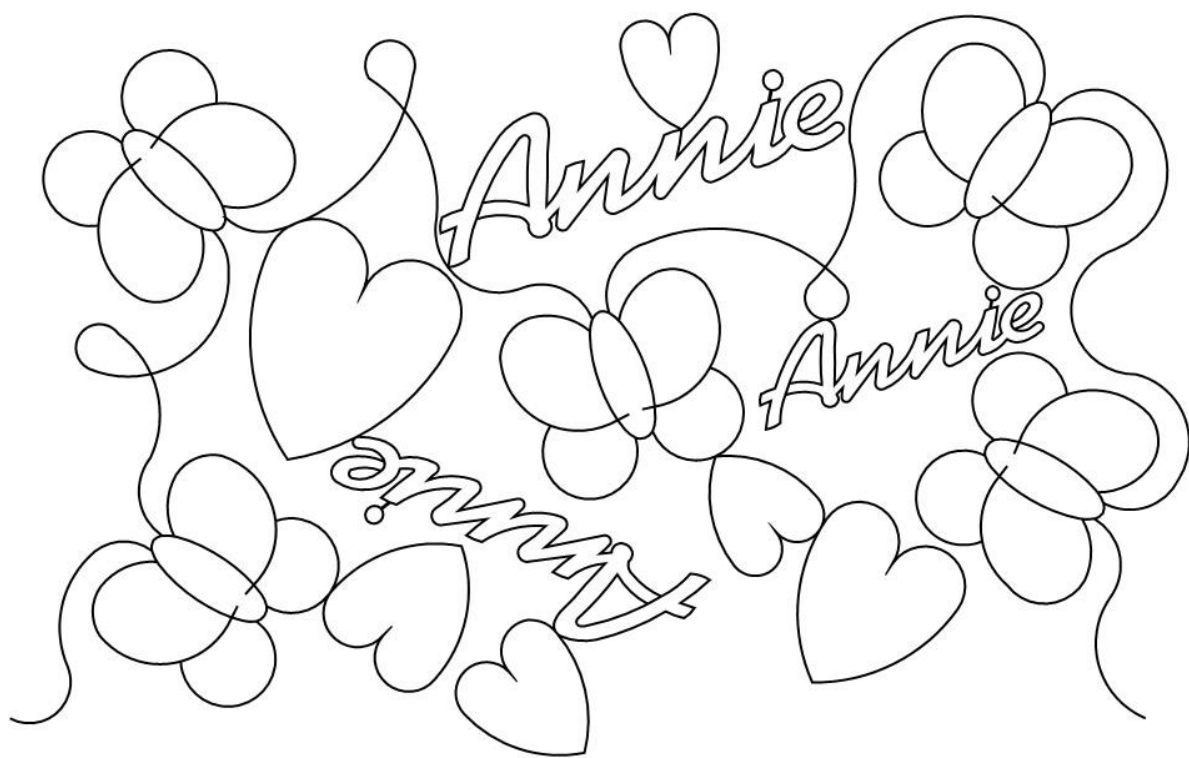

Pattern: annie pano 001

Archive: Quartz September 2015

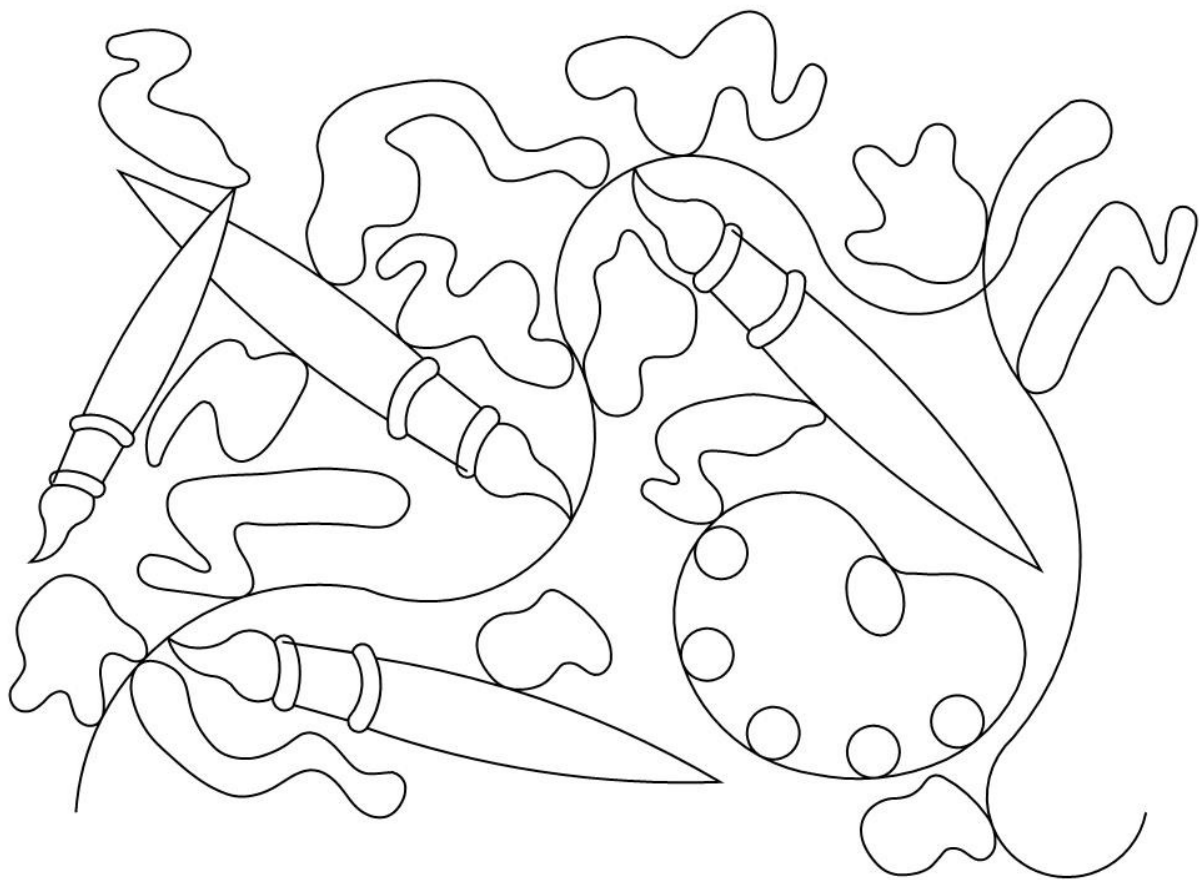

Pattern: artist pano 002

Archive: Quartz September 2015

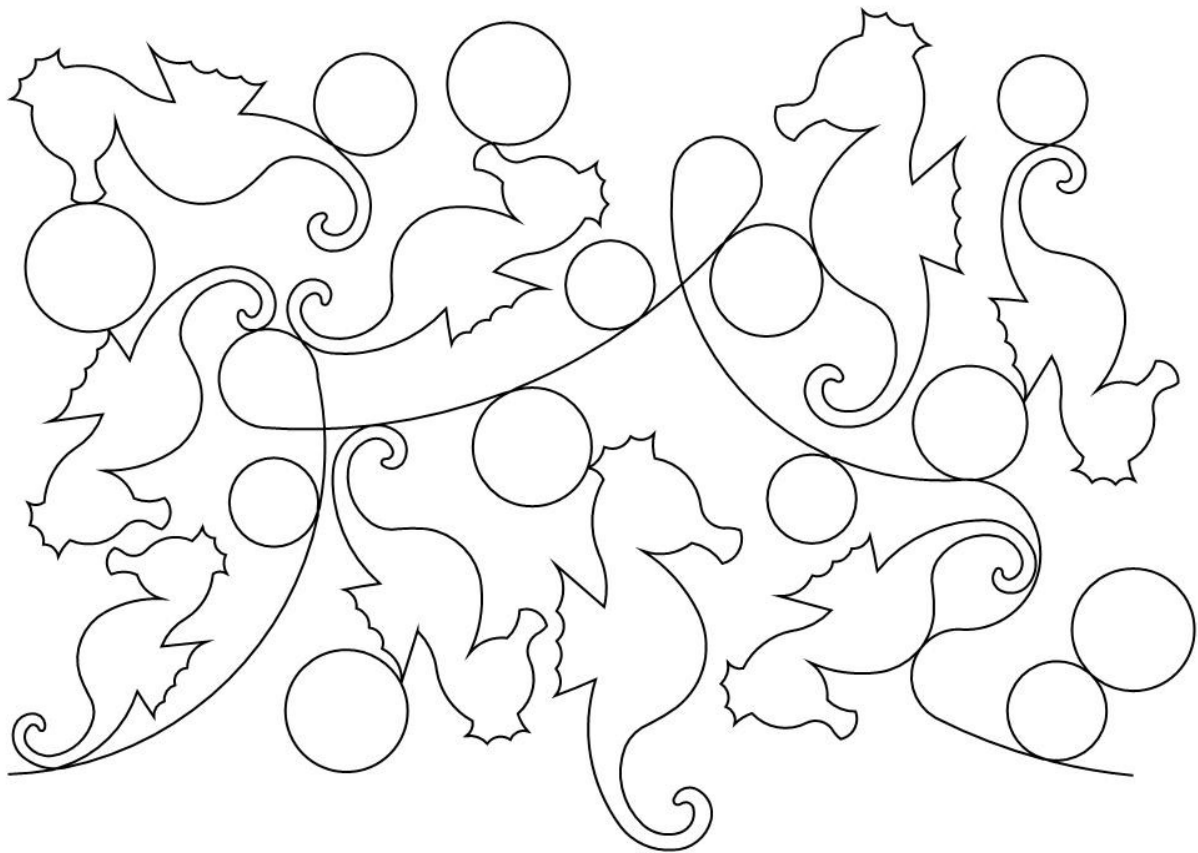

Pattern: baby seahorse pano 001

Archive: Quartz September 2015

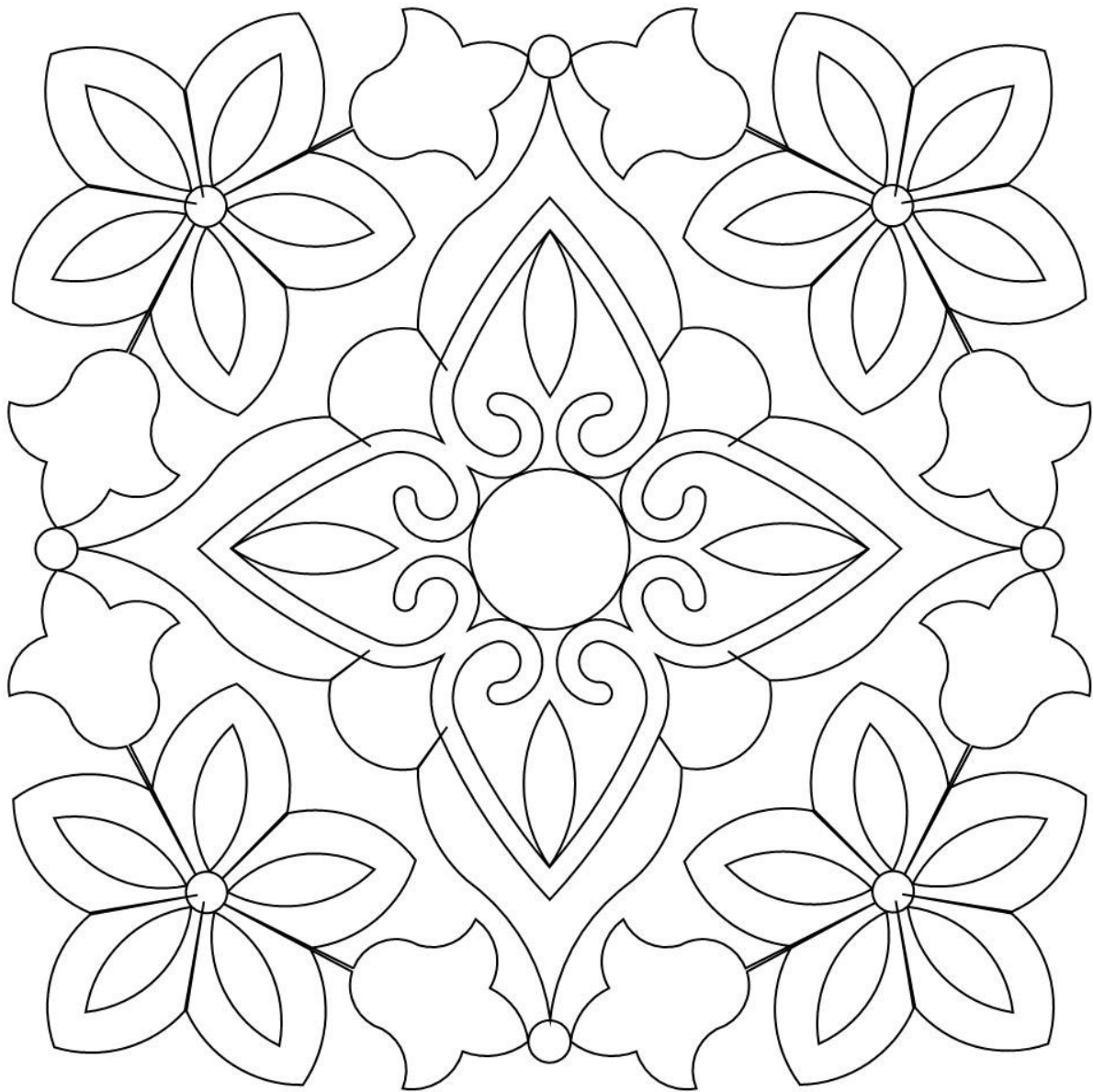

Pattern: bandana block 001

Archive: Quartz September 2015

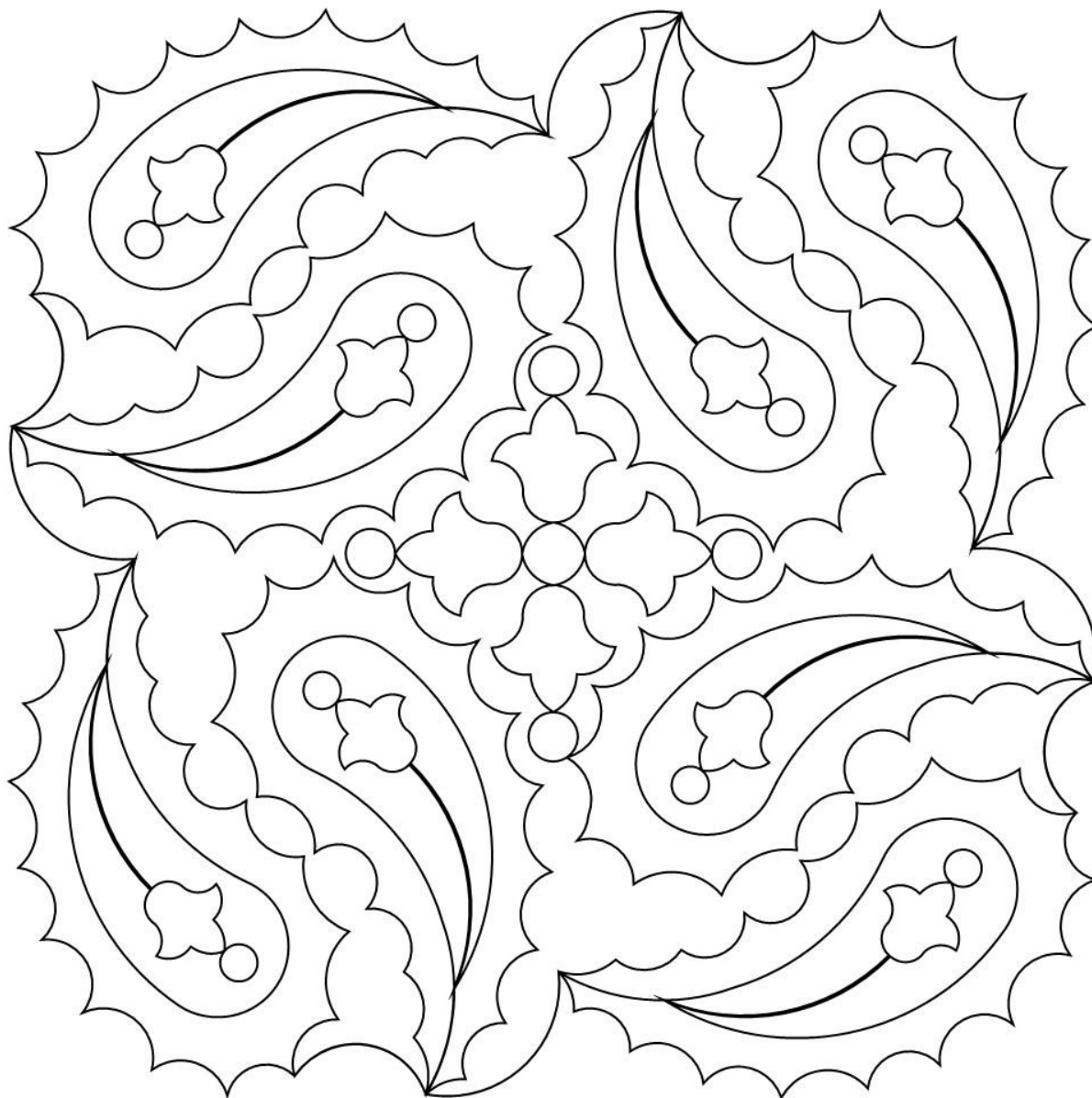

Pattern: bandana block 002

Archive: Quartz September 2015

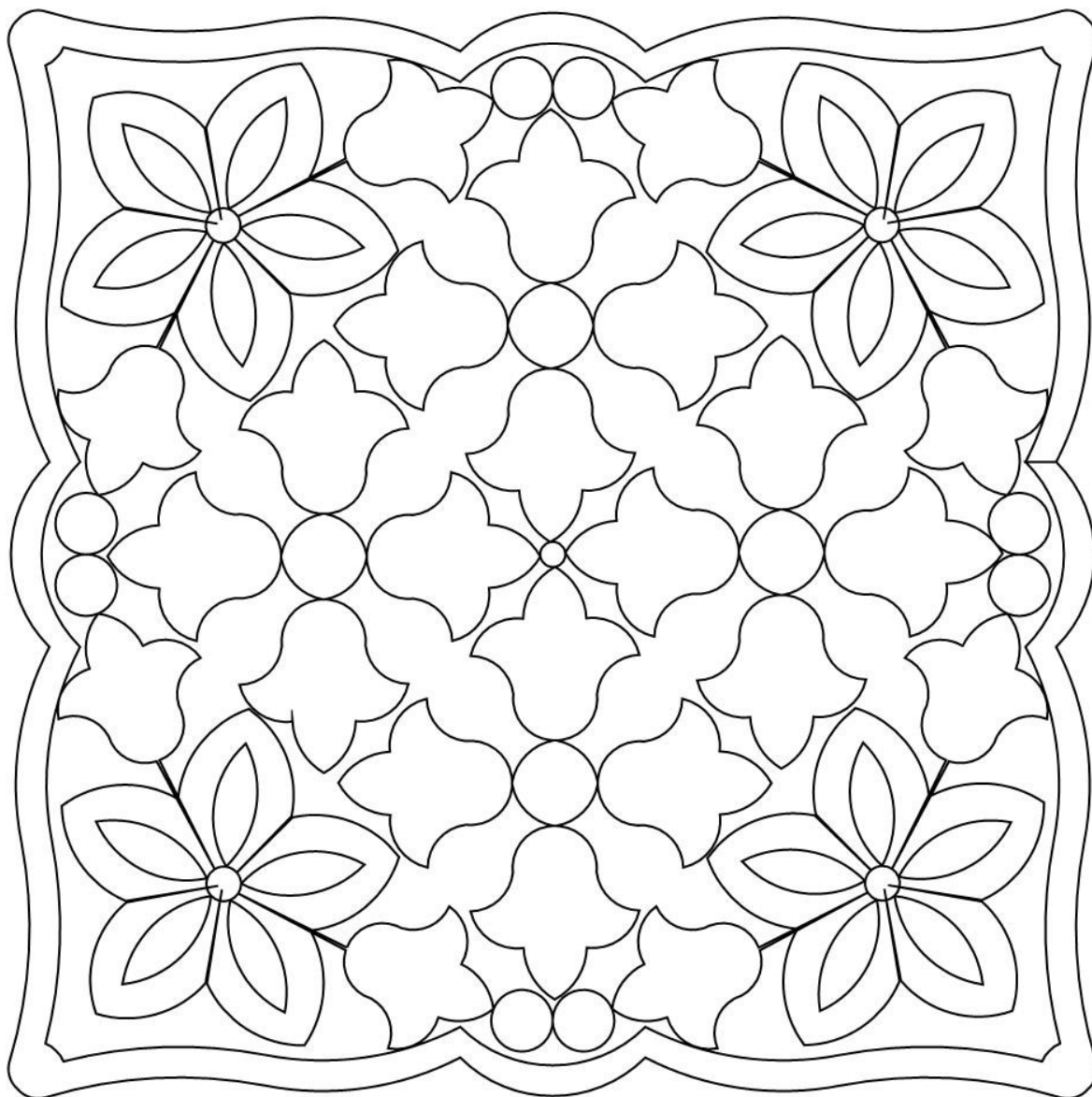

Pattern: bandana block 003

Archive: Quartz September 2015

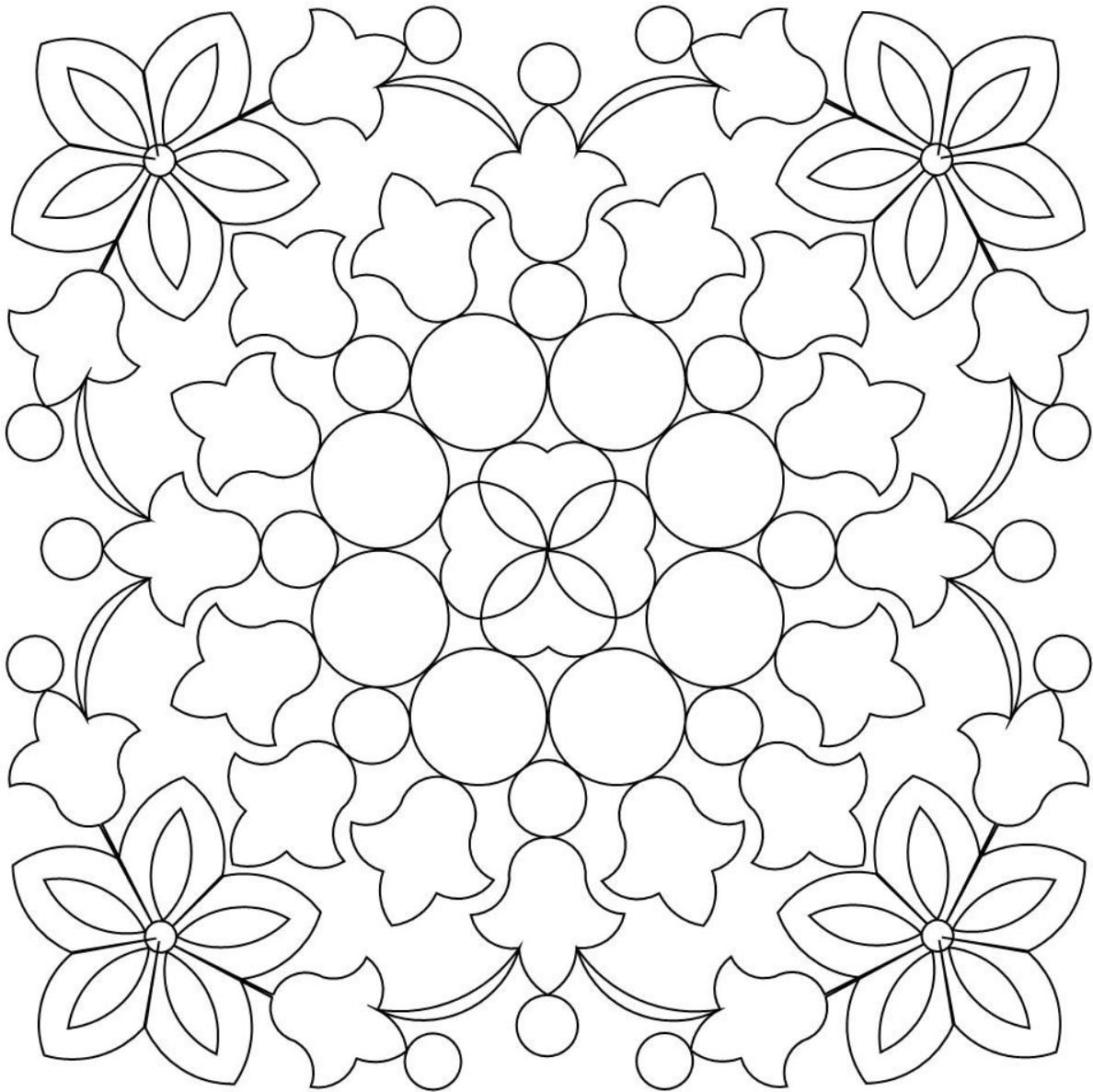

Pattern: bandana block 004

Archive: Quartz September 2015

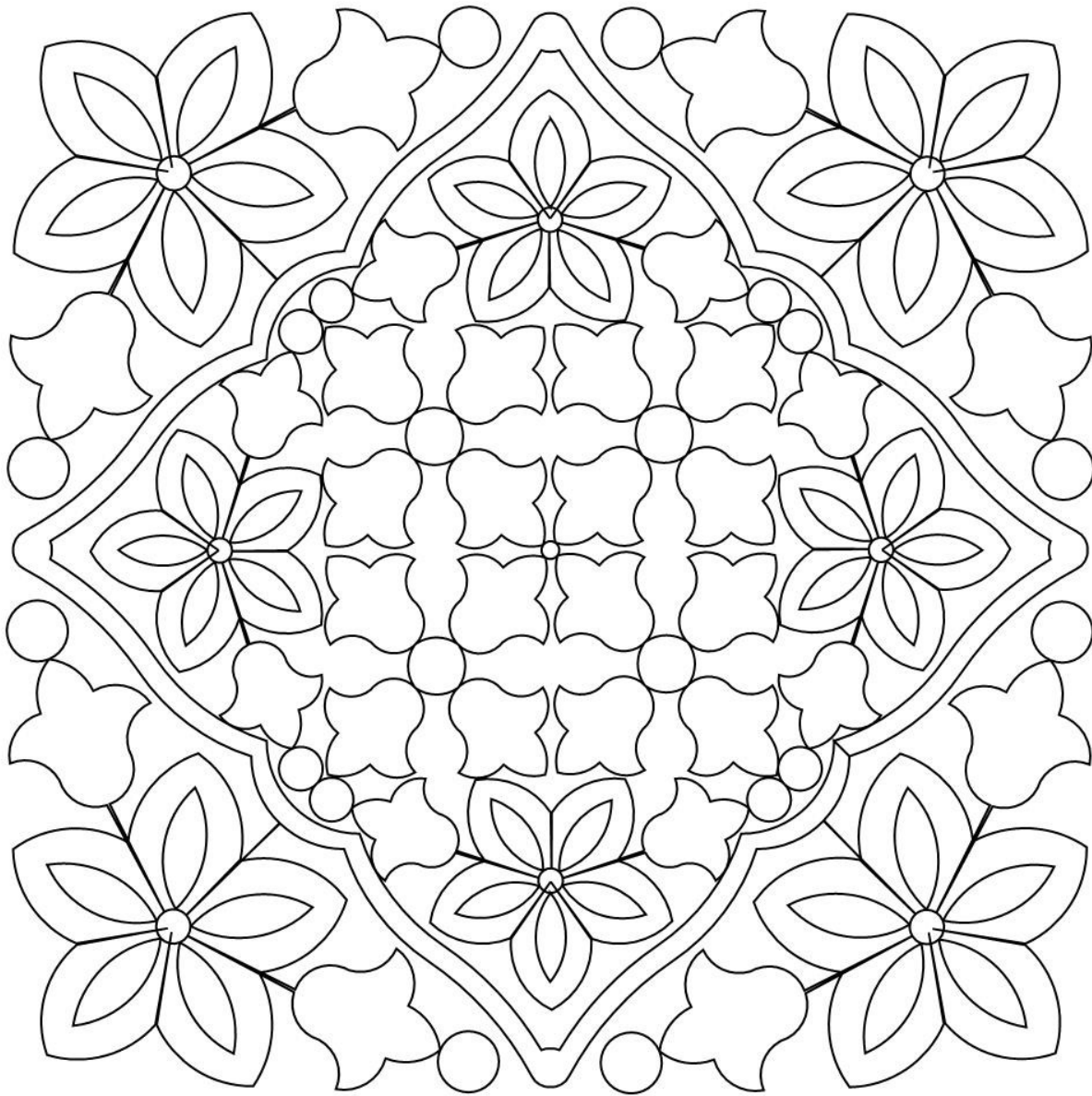

Pattern: bandana block 005

Archive: Quartz September 2015

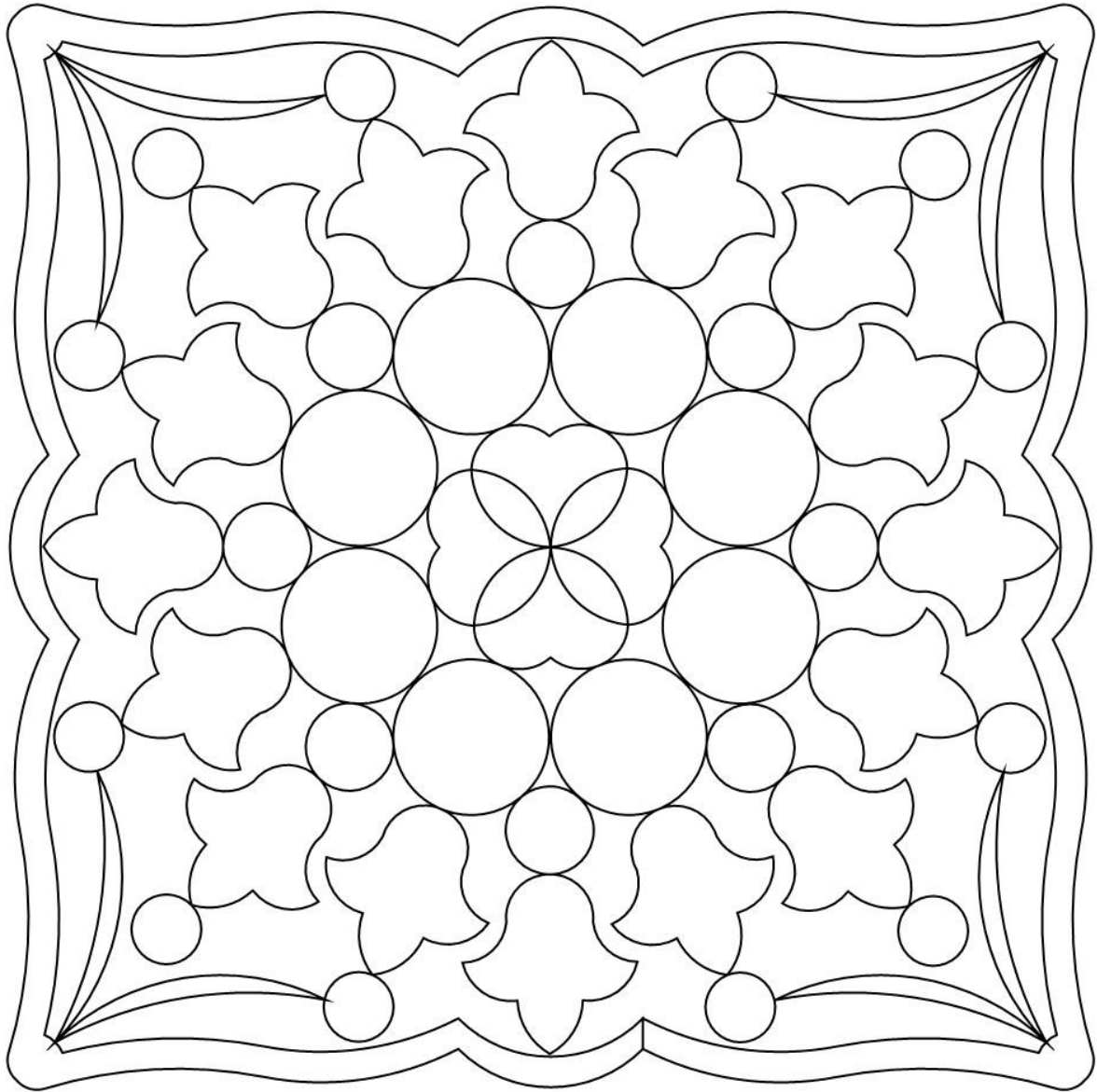

Pattern: bandana block 006

Archive: Quartz September 2015

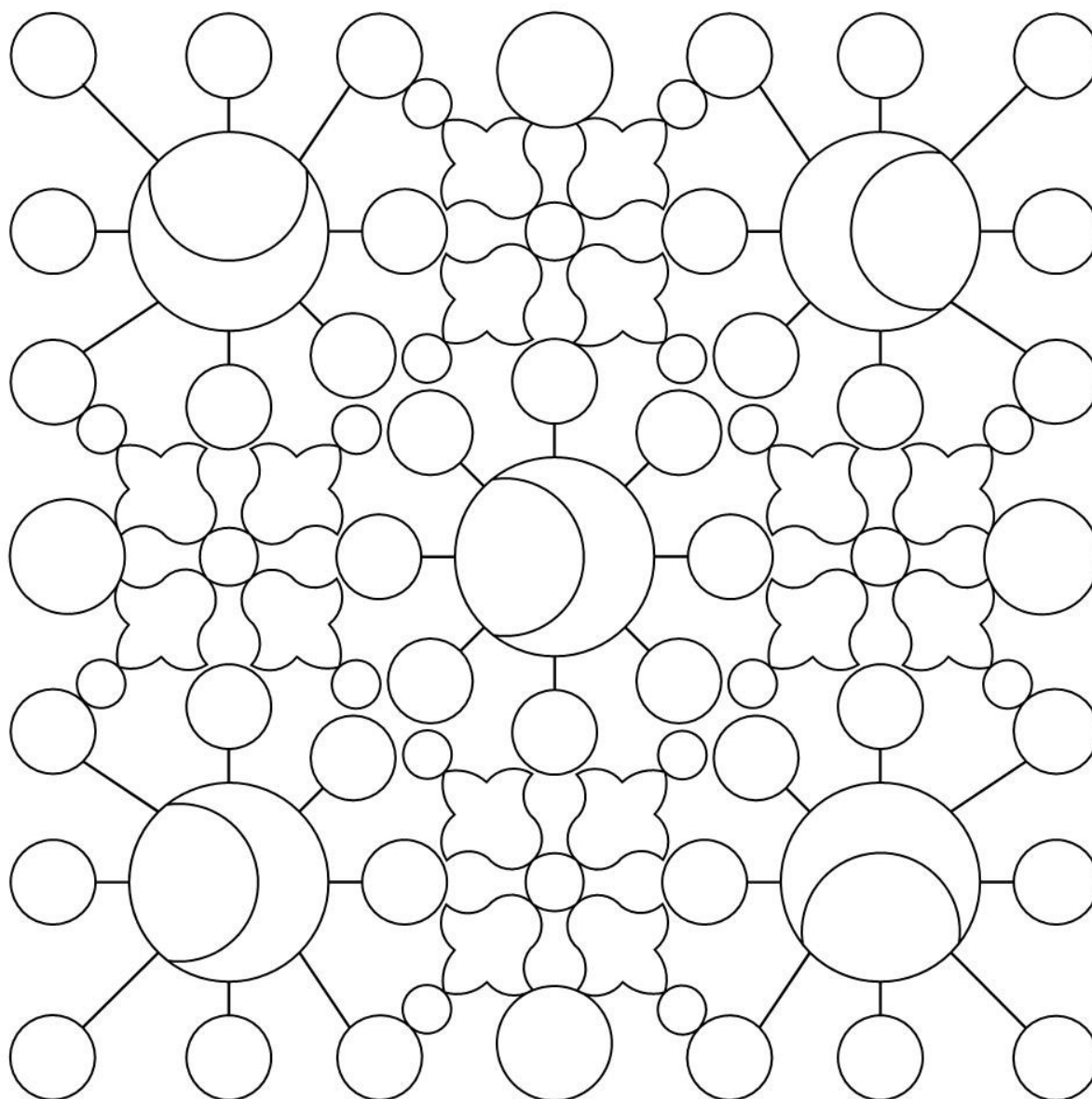

Pattern: bandana block 007

Archive: Quartz September 2015

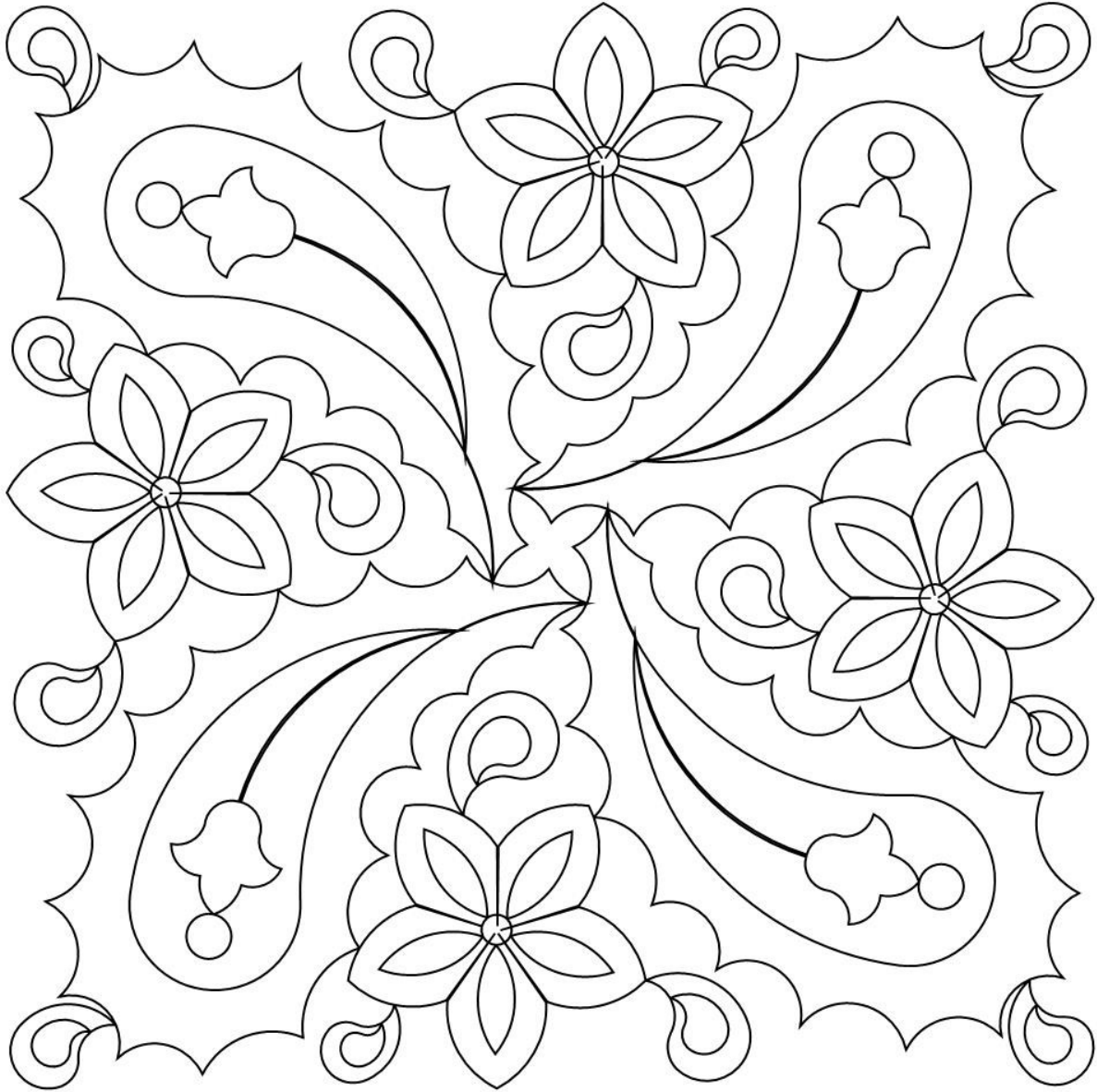

Pattern: bandana block 008

Archive: Quartz September 2015

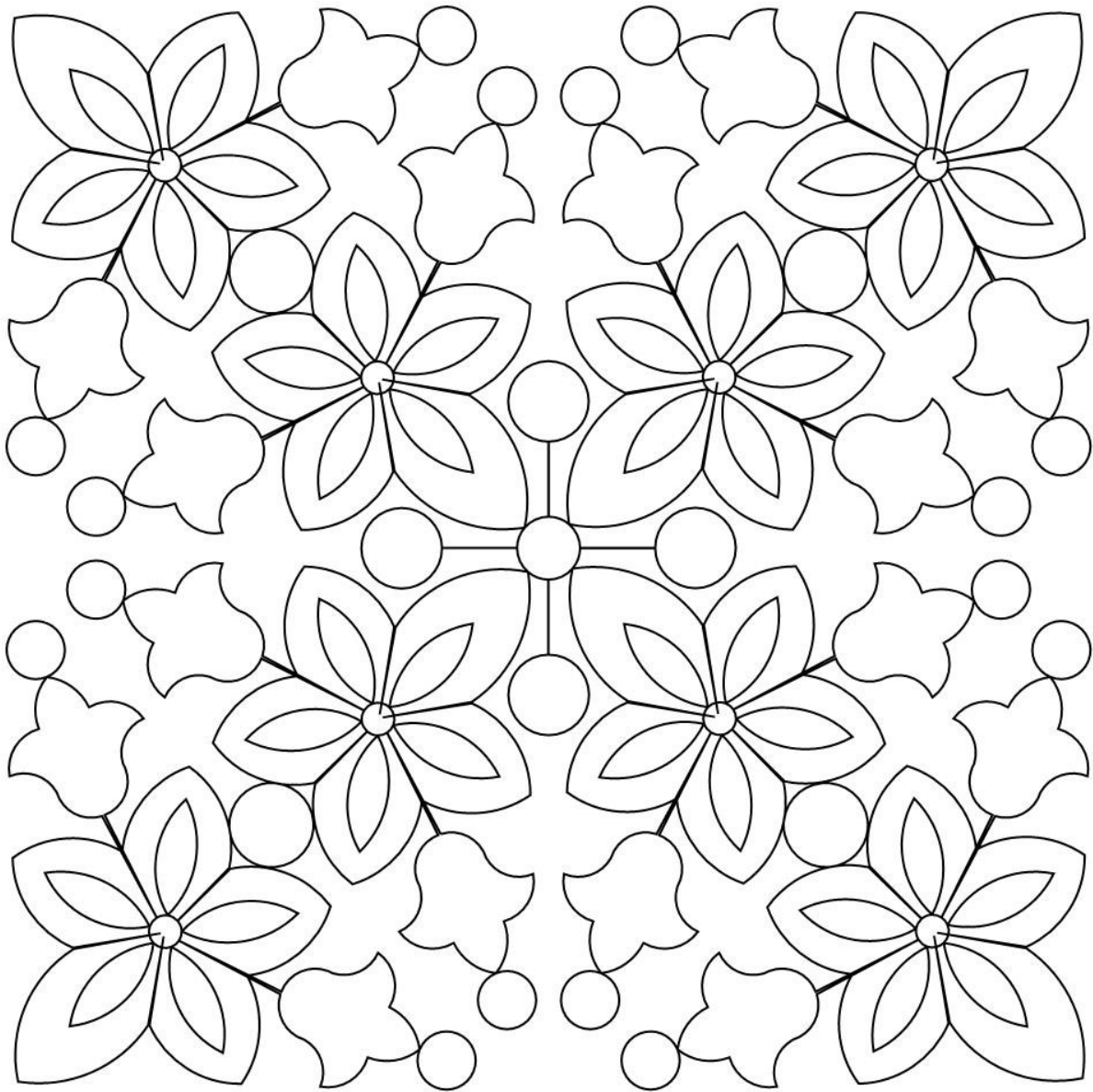

Pattern: bandana block 009

Archive: Quartz September 2015

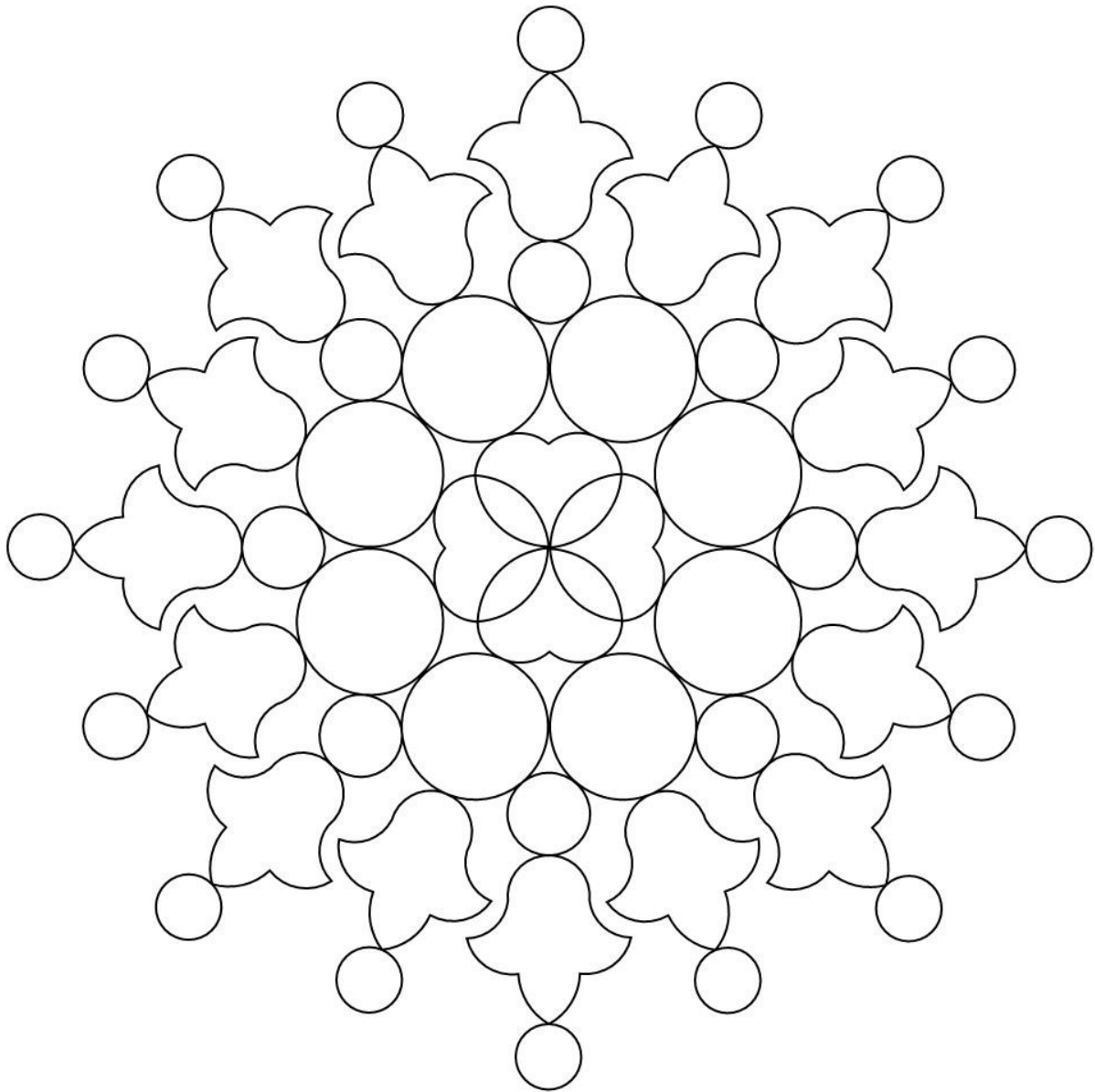

Pattern: bandana block 010

Archive: Quartz September 2015

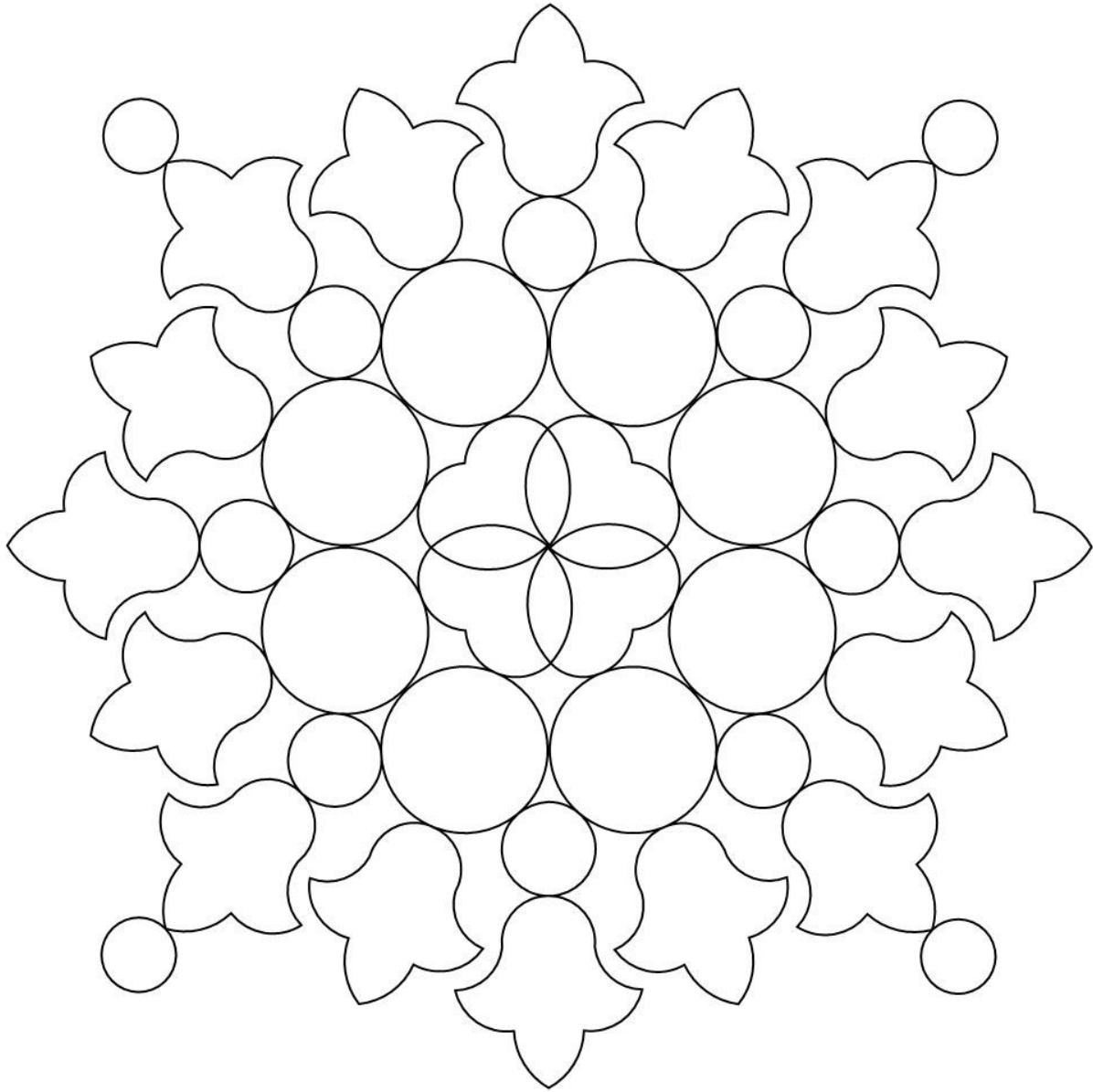

Pattern: bandana block 011

Archive: Quartz September 2015

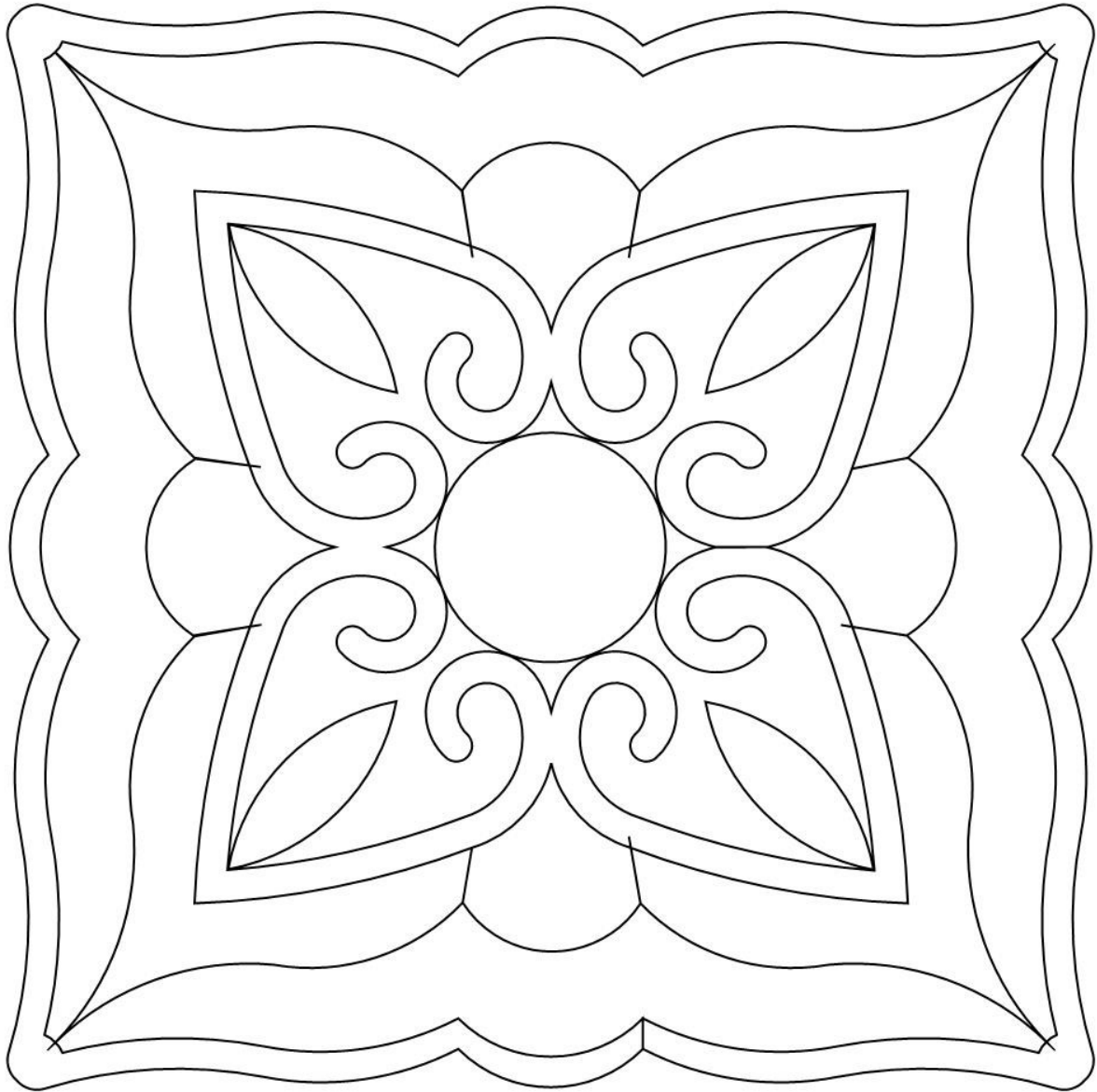

Pattern: bandana block 012

Archive: Quartz September 2015

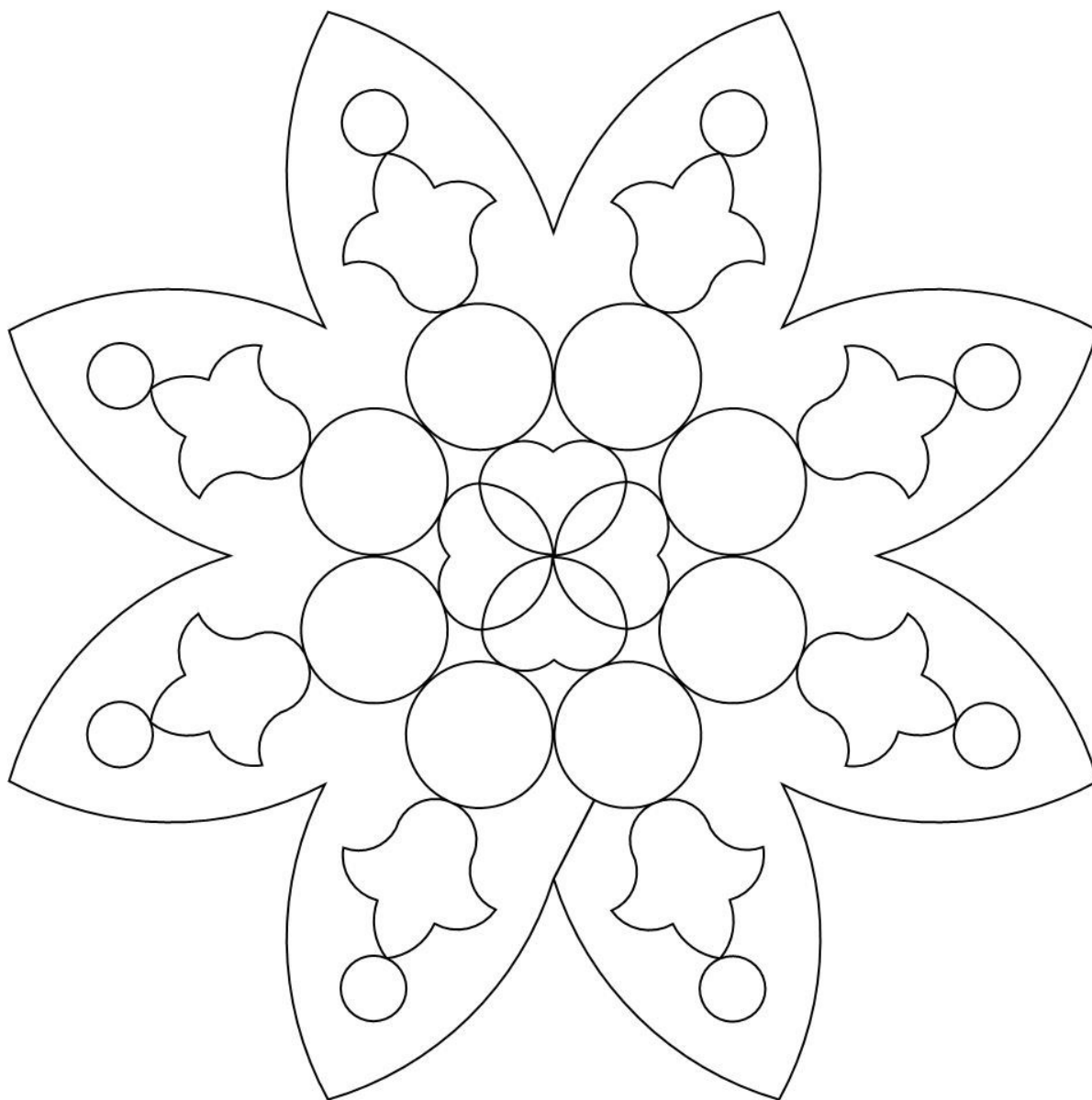

Pattern: bandana block 013

Archive: Quartz September 2015

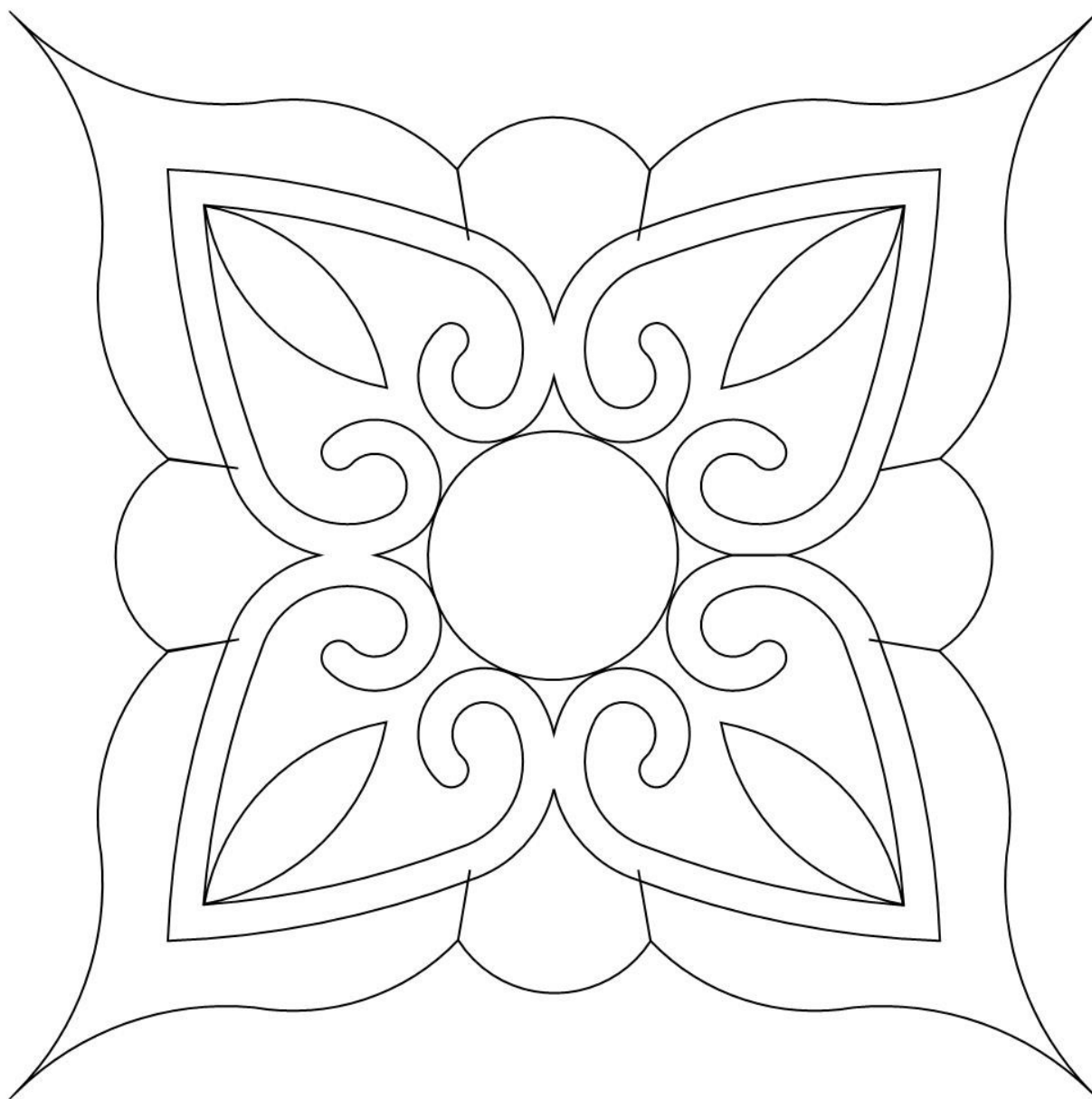

Pattern: bandana block 014

Archive: Quartz September 2015

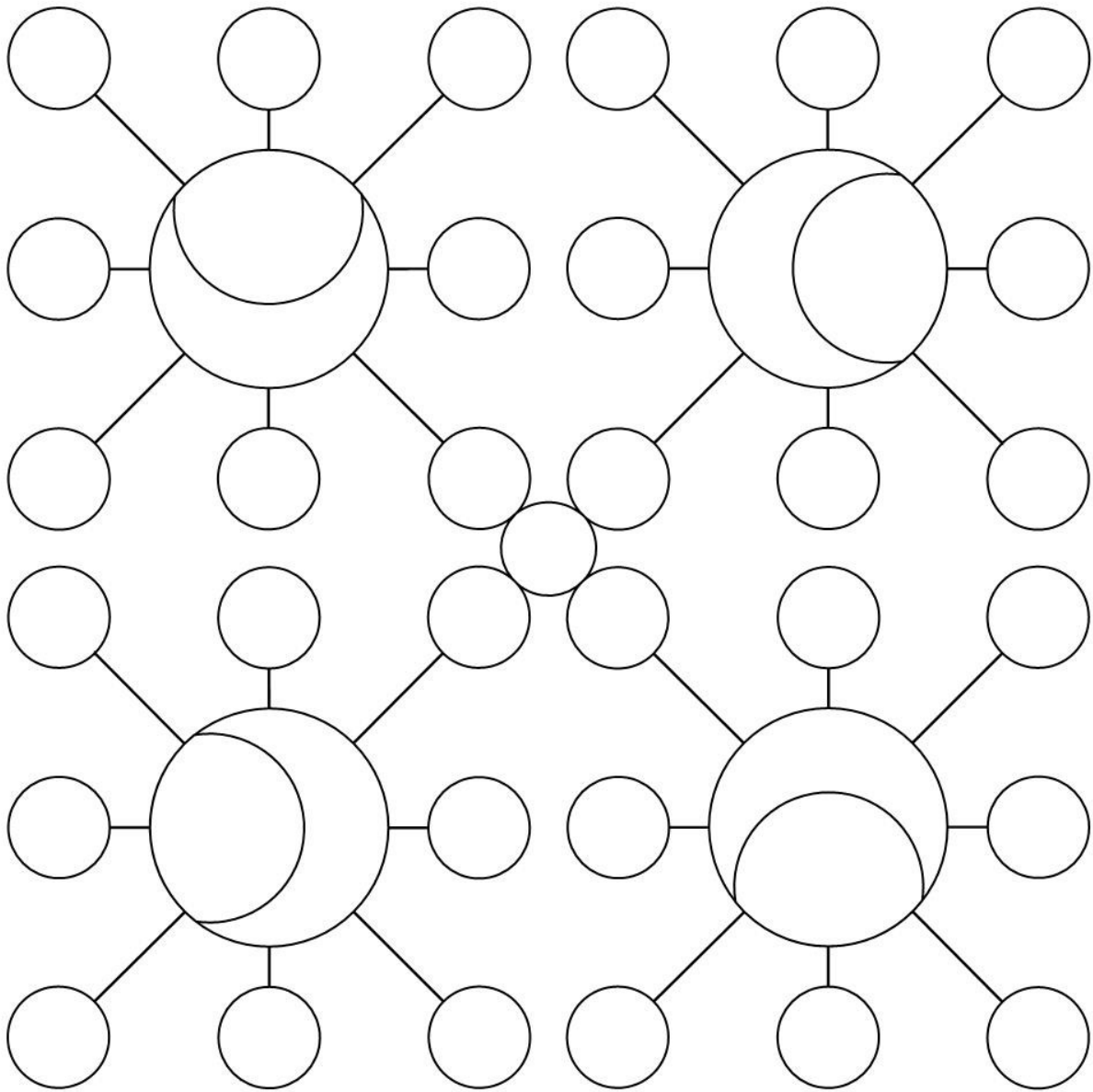

Pattern: bandana block 015

Archive: Quartz September 2015

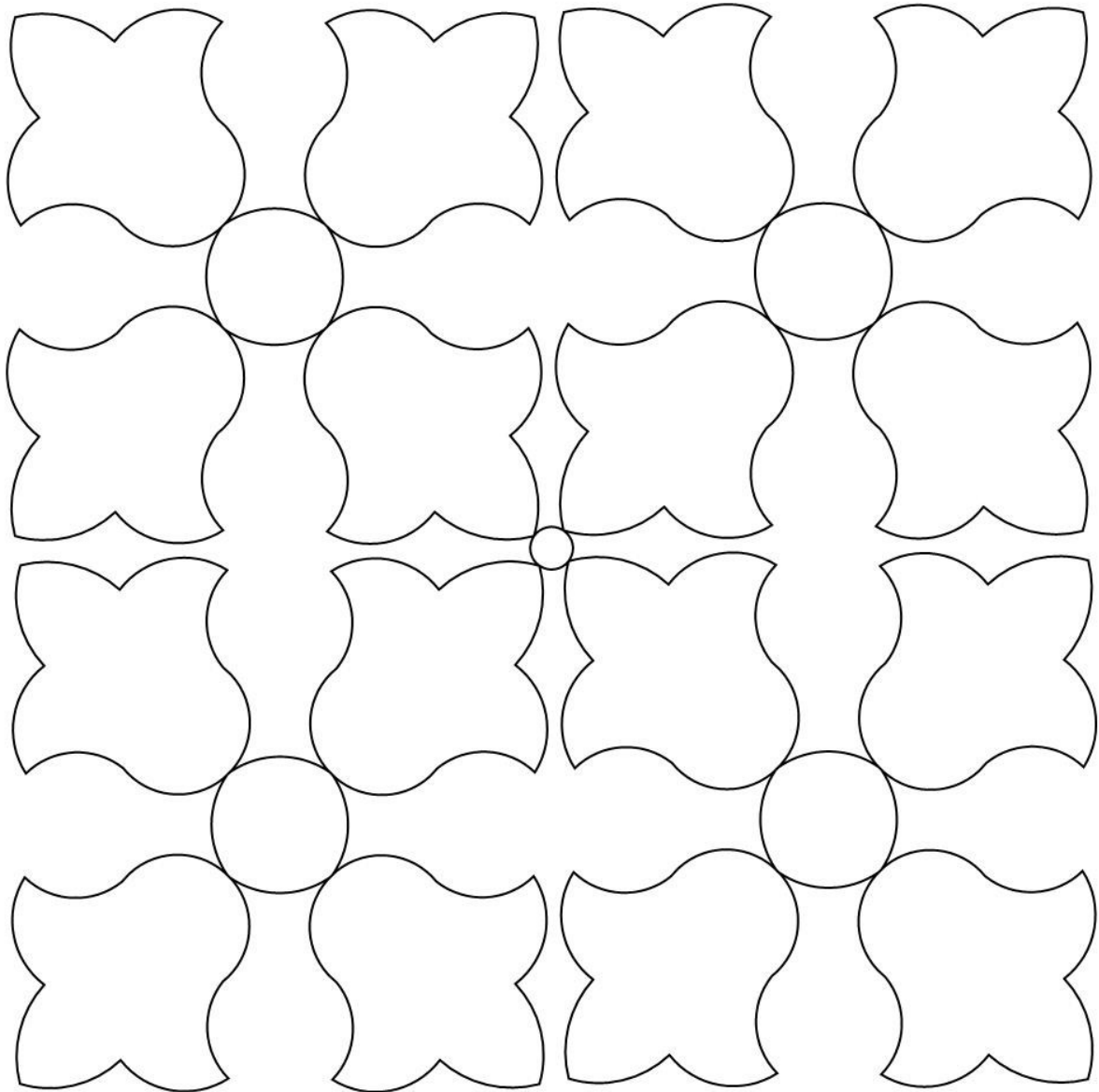

Pattern: bandana block 016

Archive: Quartz September 2015

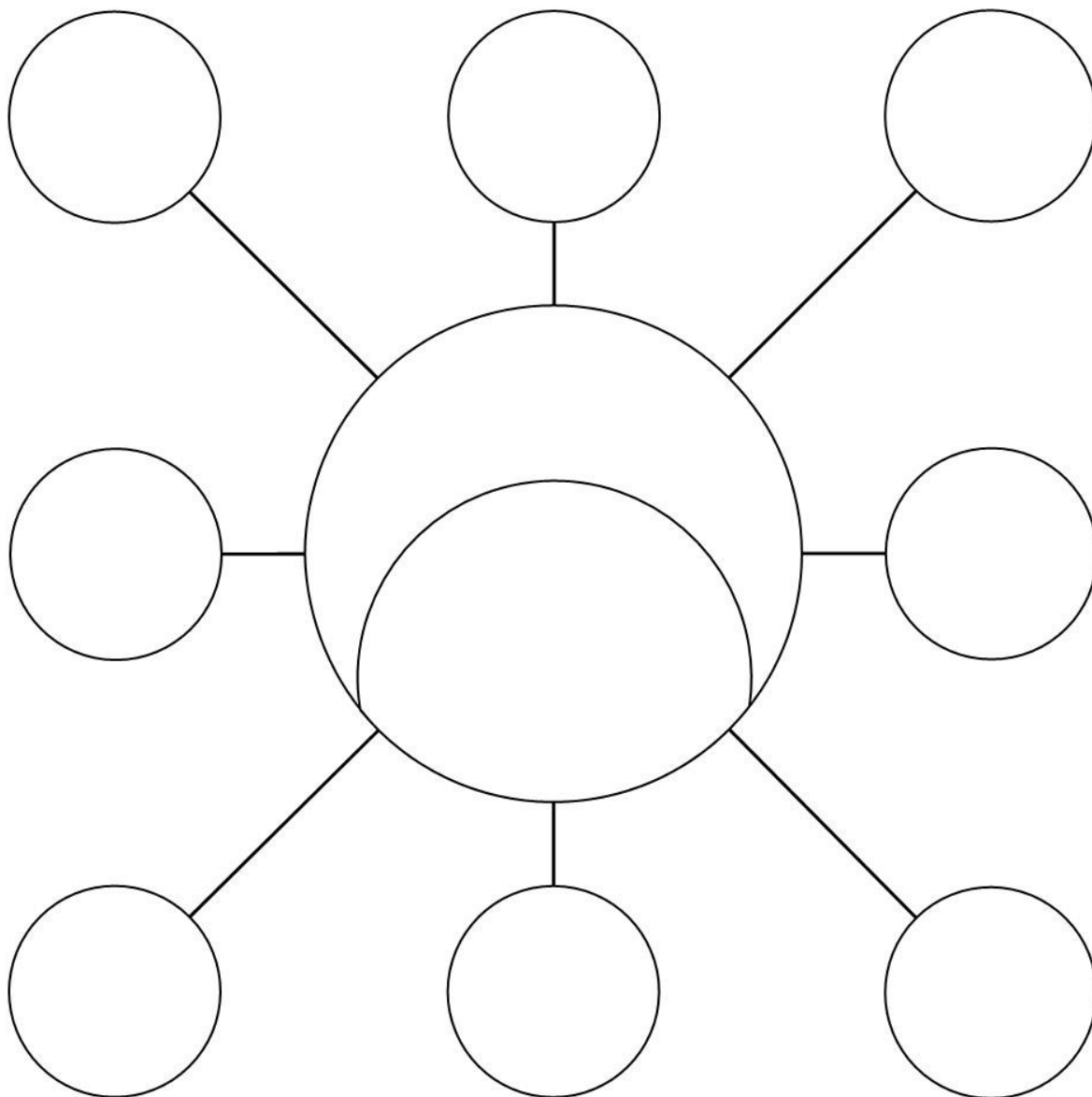

Pattern: bandana block 017

Archive: Quartz September 2015

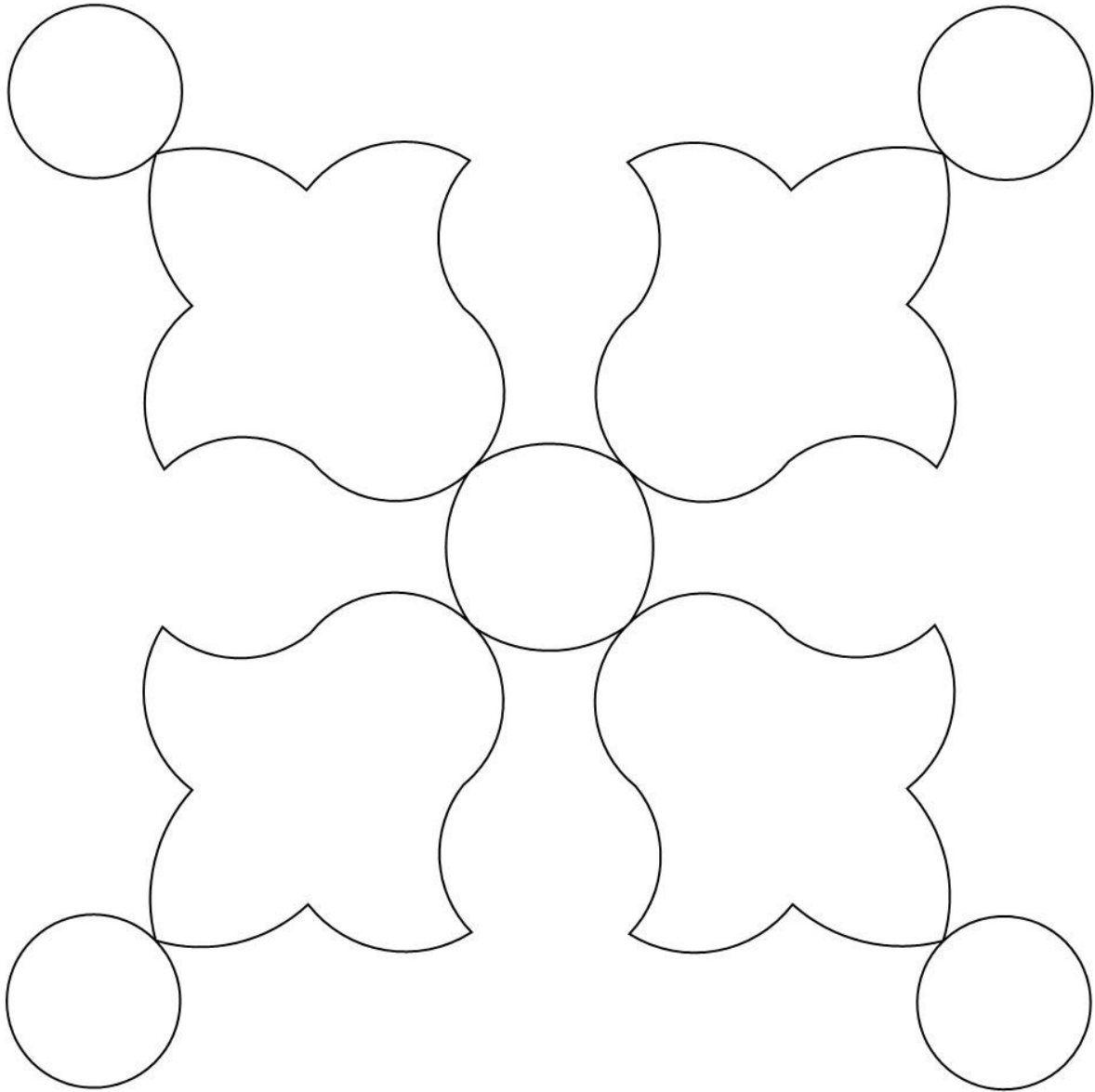

Pattern: bandana block 018

Archive: Quartz September 2015

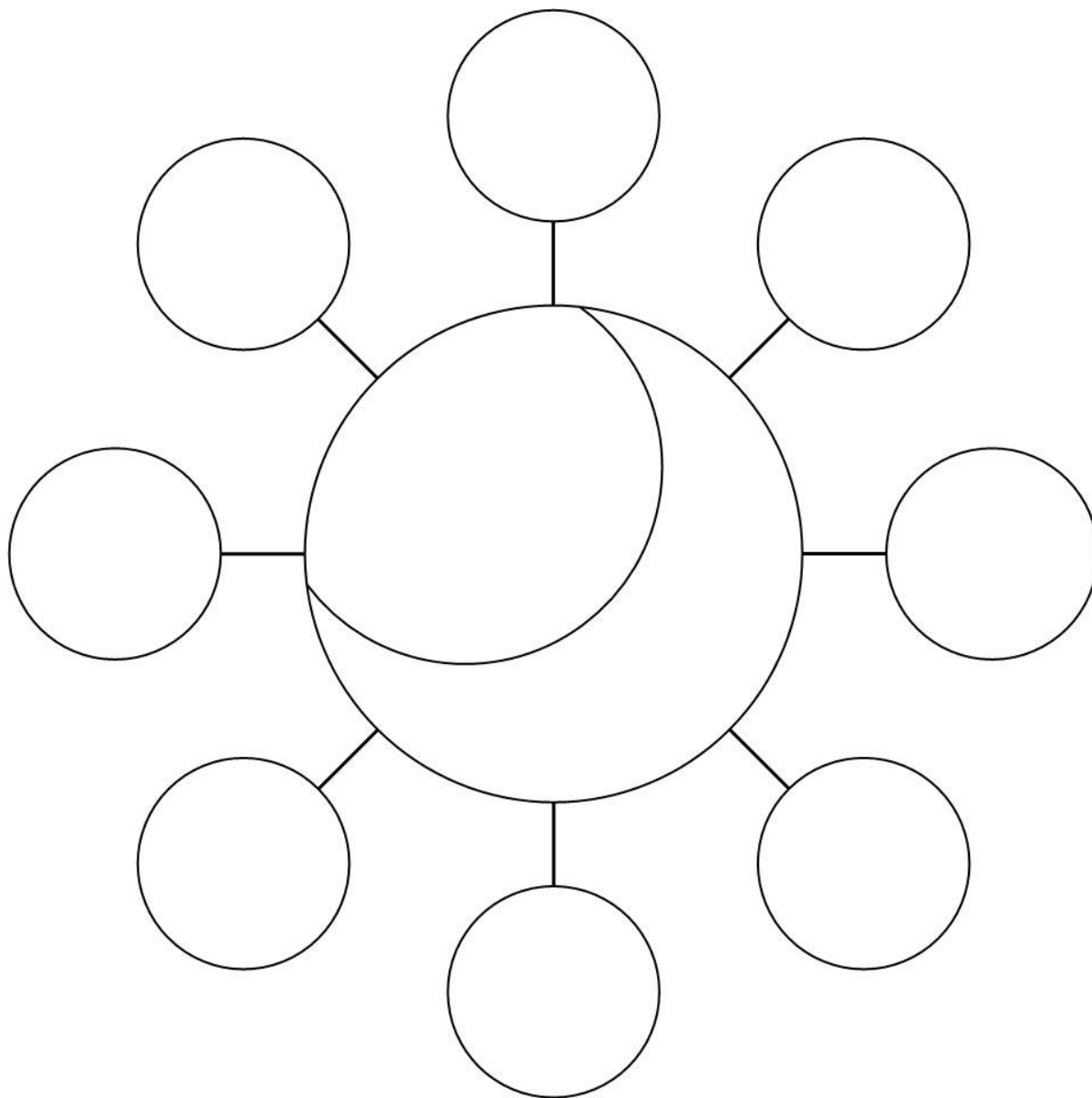

Pattern: bandana block 019

Archive: Quartz September 2015

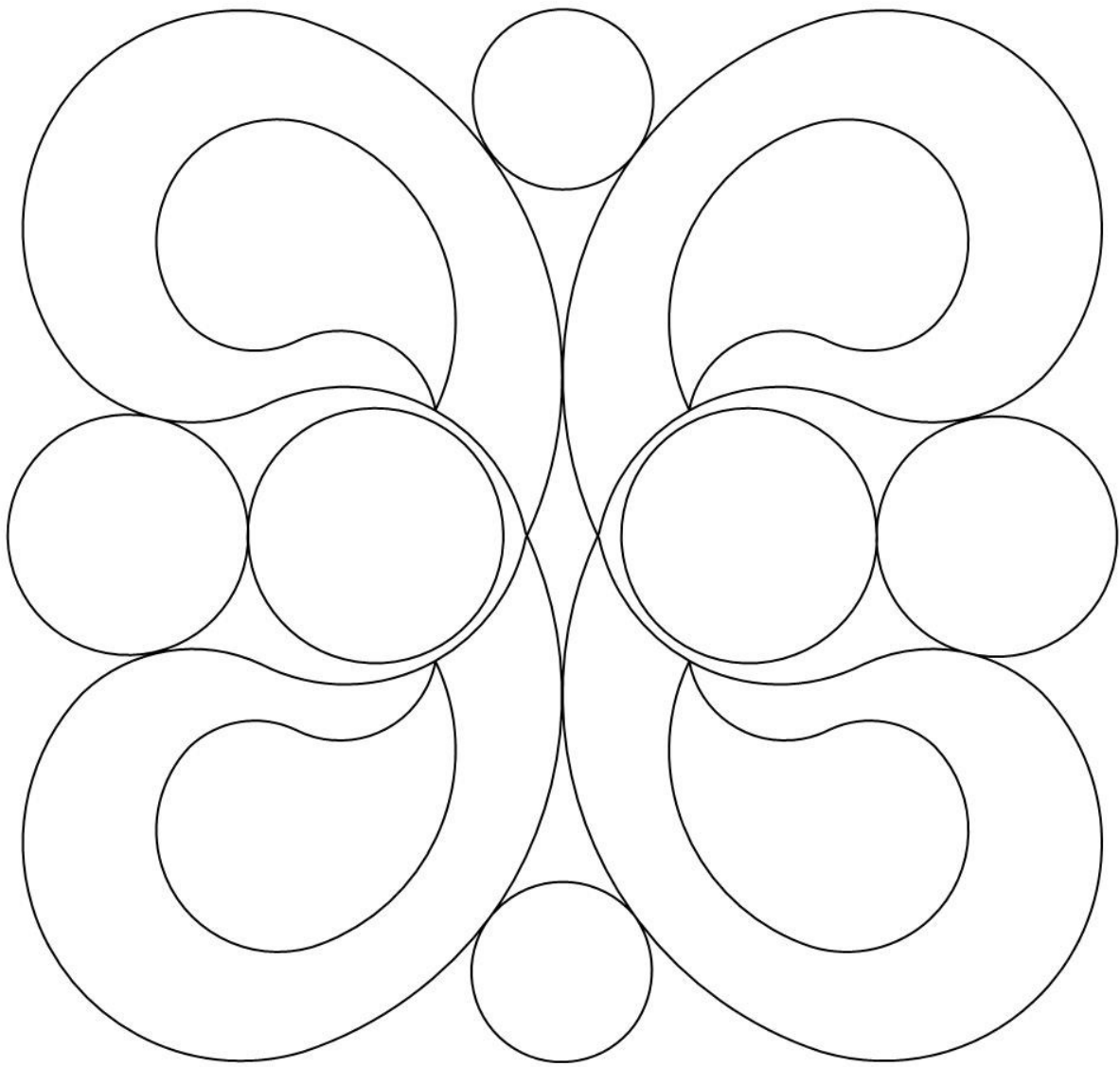

Pattern: bandana block 020

Archive: Quartz September 2015

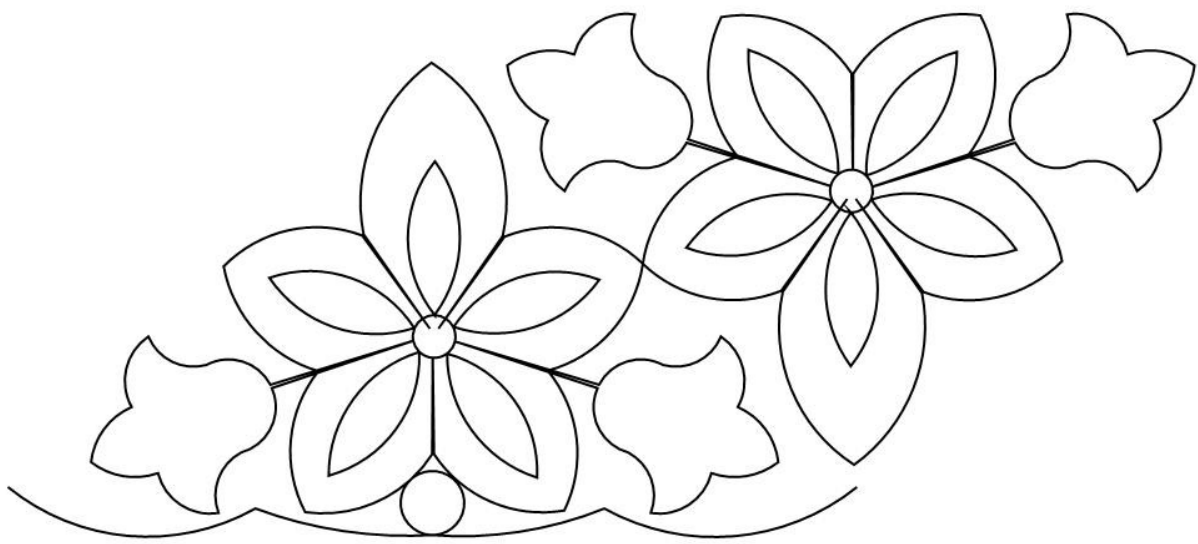

Pattern: bandana border 001

Archive: Quartz September 2015

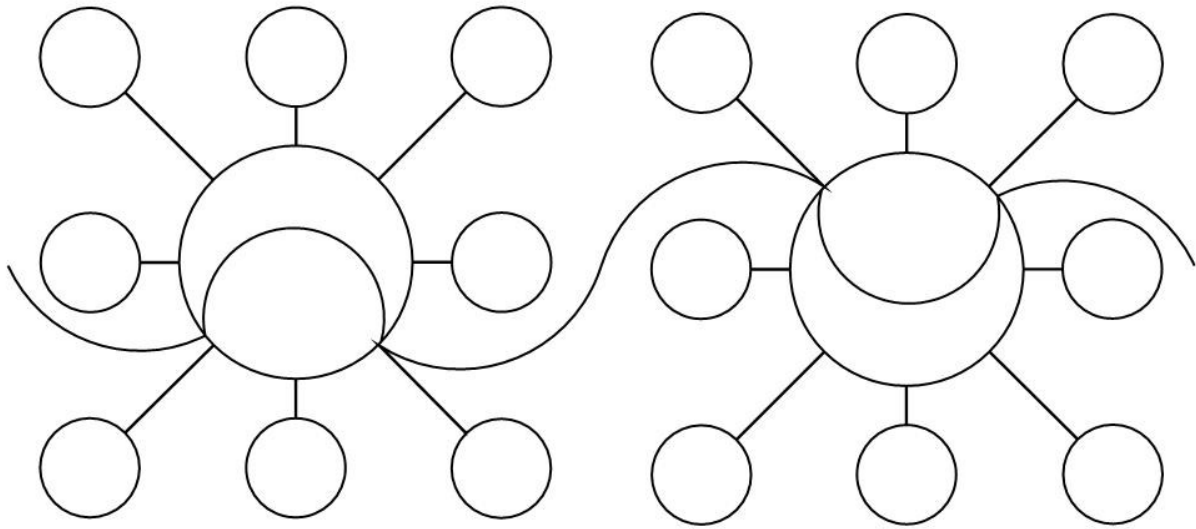

Pattern: bandana border 002

Archive: Quartz September 2015

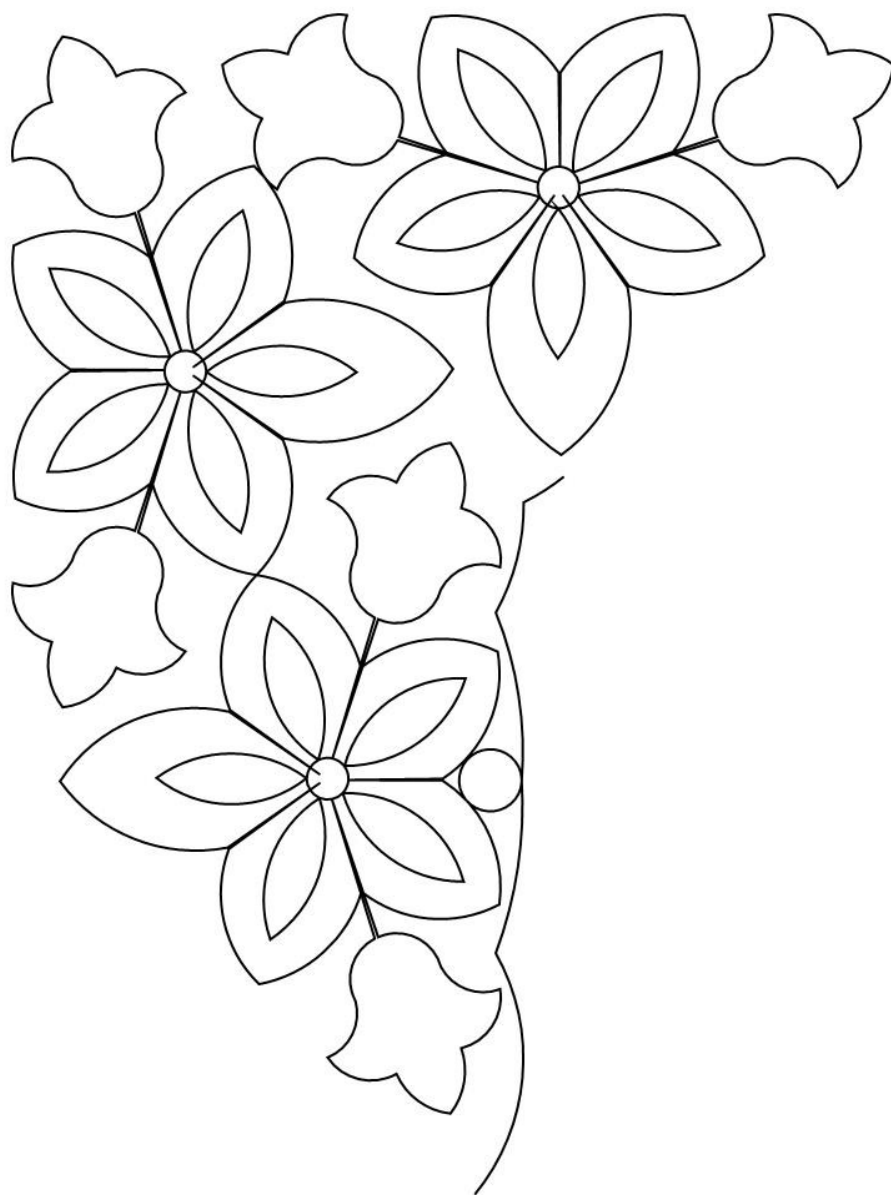

Pattern: bandana brd crn 001

Archive: Quartz September 2015

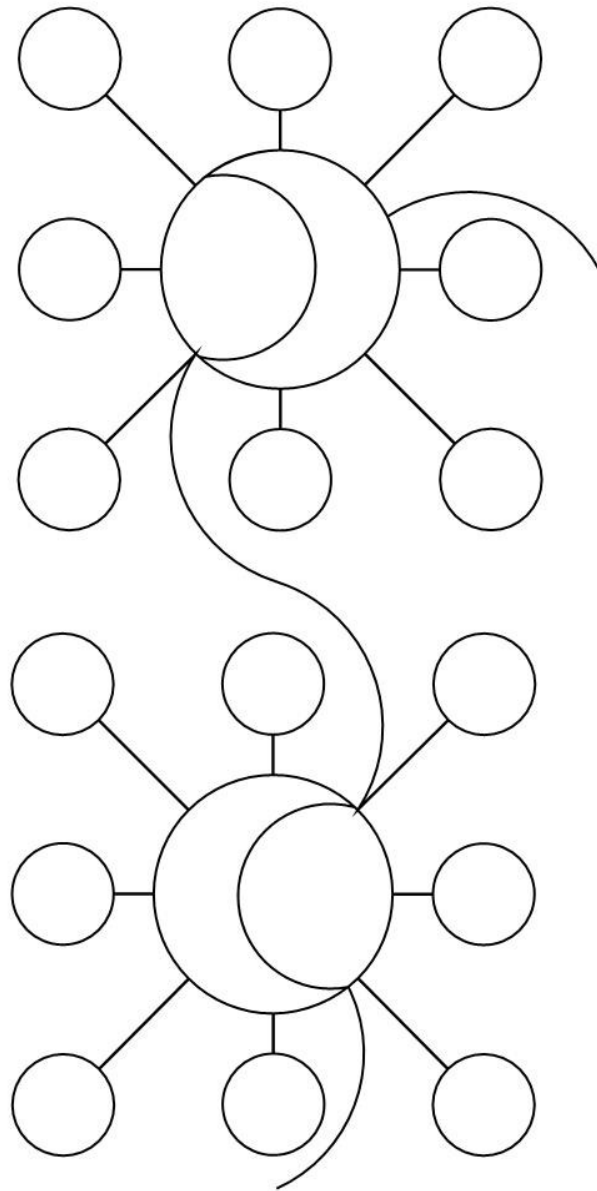

Pattern: bandana brd crn 002

Archive: Quartz September 2015

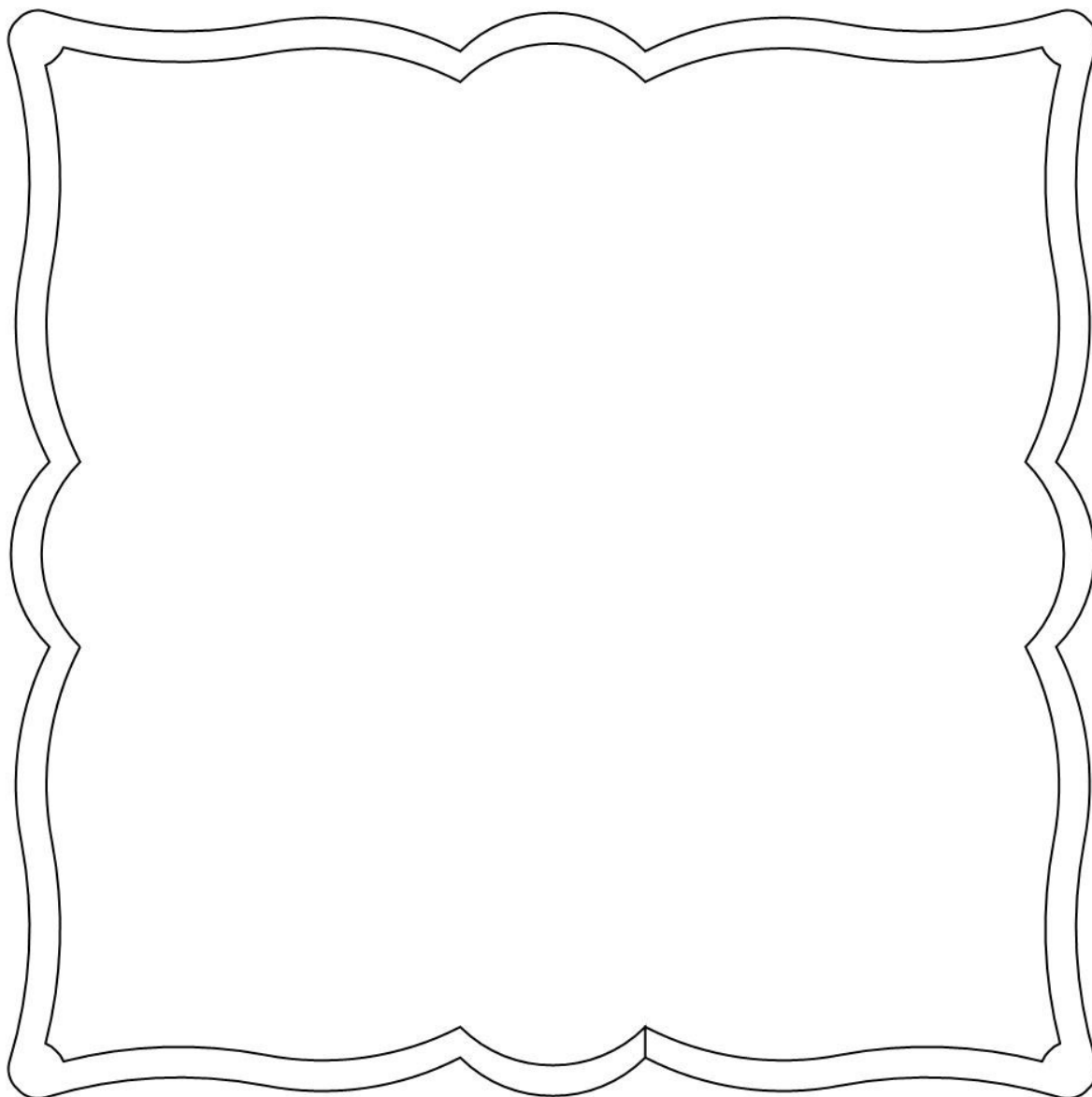

Pattern: bandana frame 001

Archive: Quartz September 2015

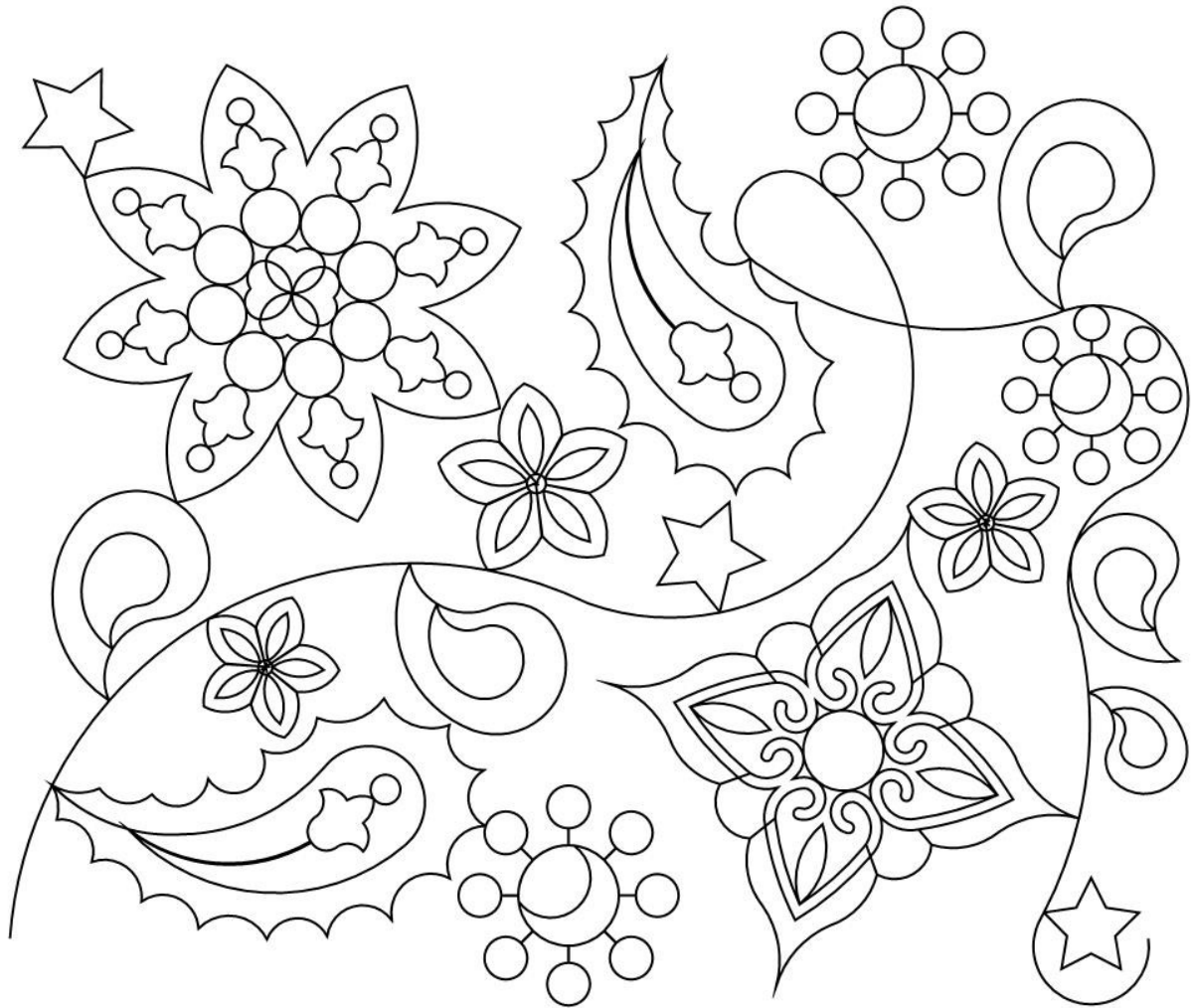

Pattern: bandana pano 001

Archive: Quartz September 2015

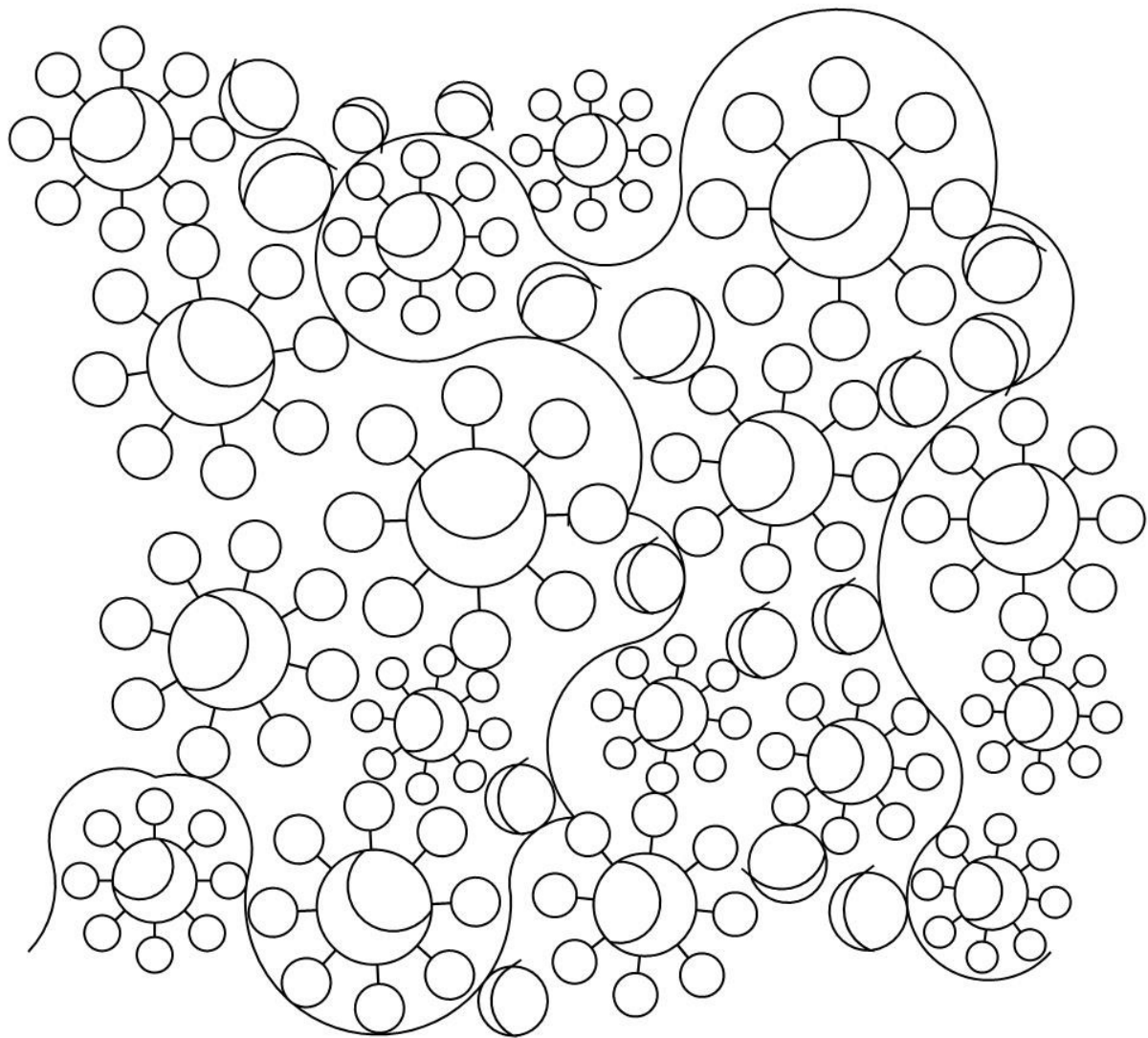

Pattern: bandana pano 002

Archive: Quartz September 2015

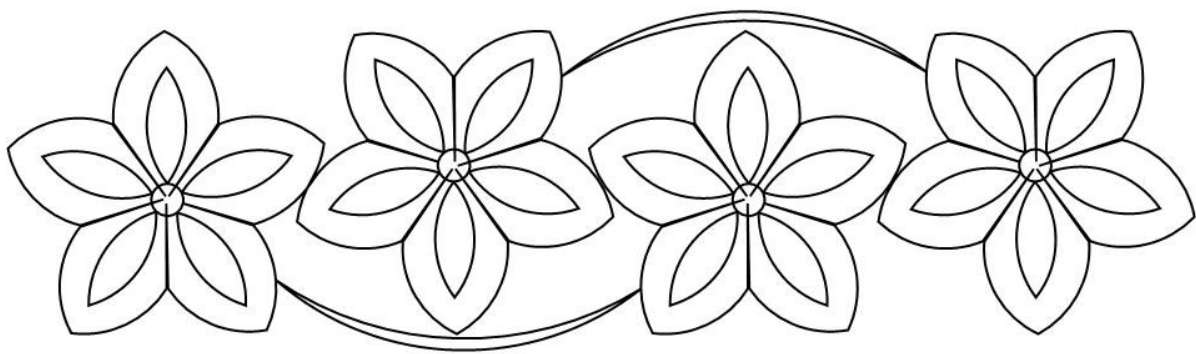

Pattern: bandana sash 001

Archive: Quartz September 2015

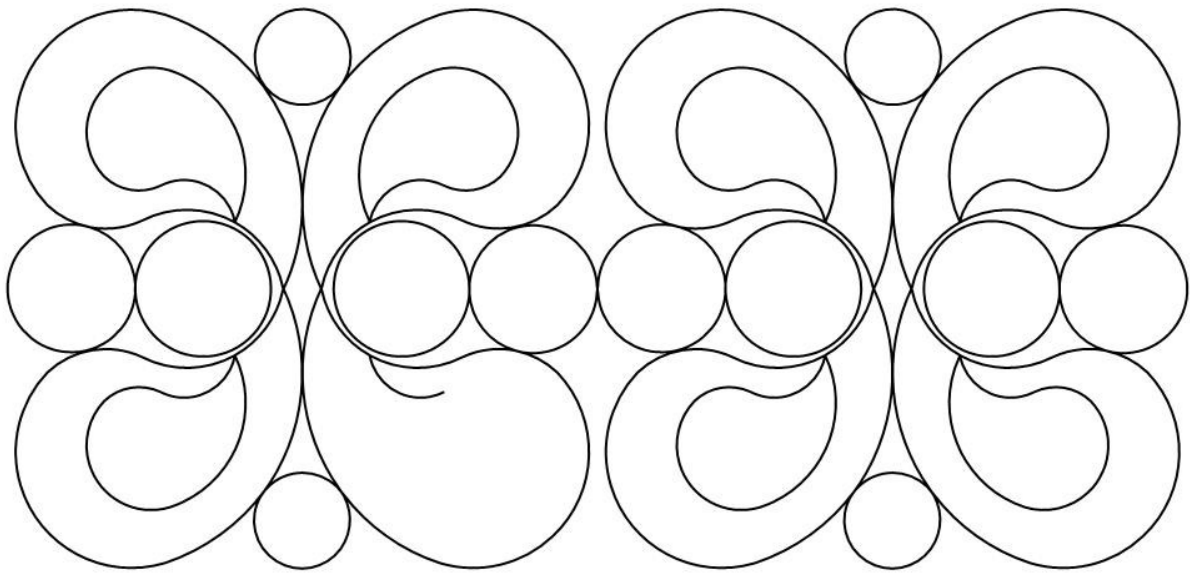

Pattern: bandana sash 002

Archive: Quartz September 2015

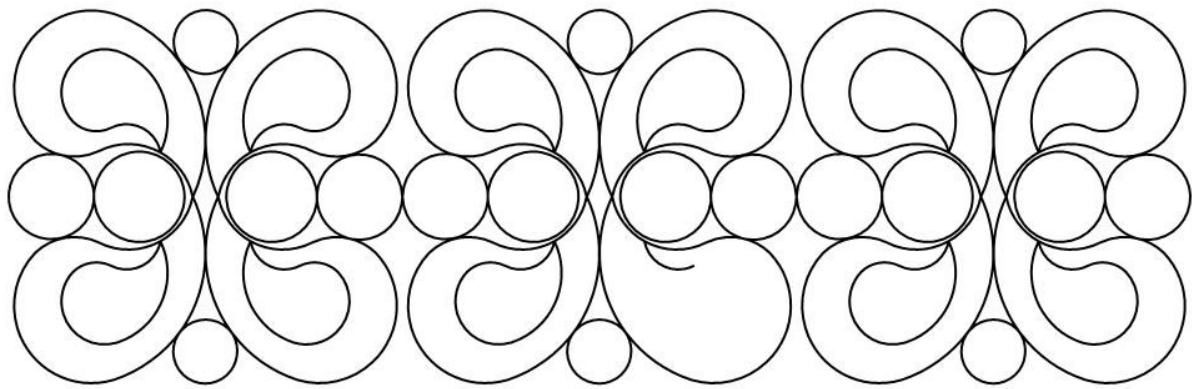

Pattern: bandana sash 003

Archive: Quartz September 2015

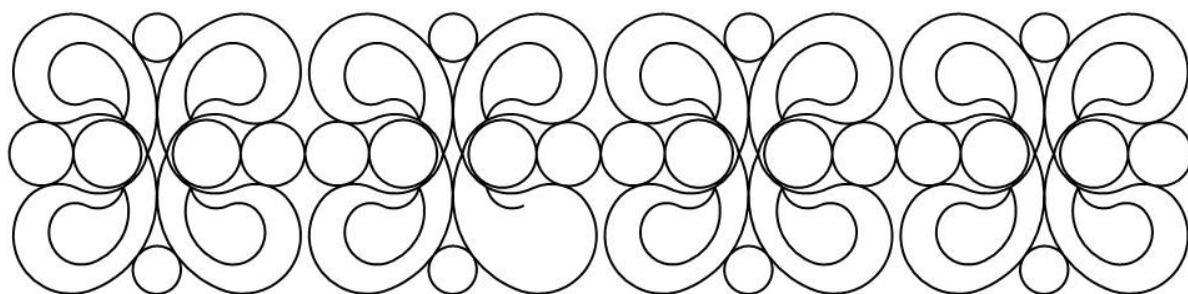

Pattern: bandana sash 004

Archive: Quartz September 2015

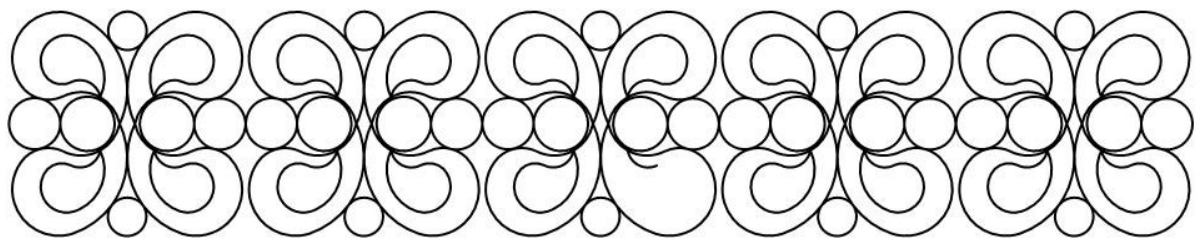

Pattern: bandana sash 005

Archive: Quartz September 2015

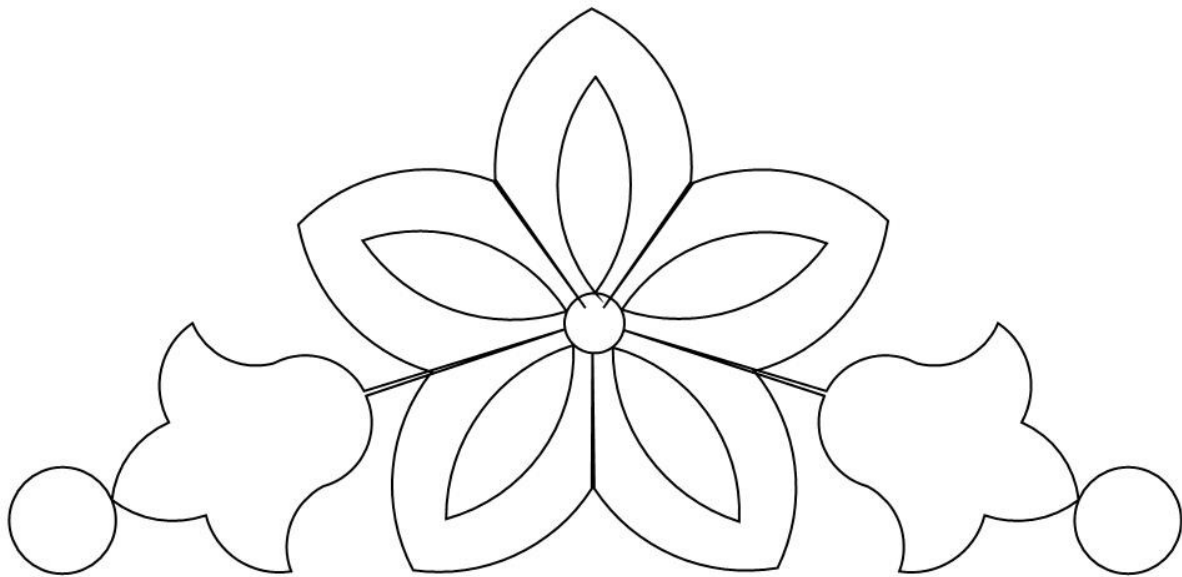

Pattern: bandana tri 001

Archive: Quartz September 2015

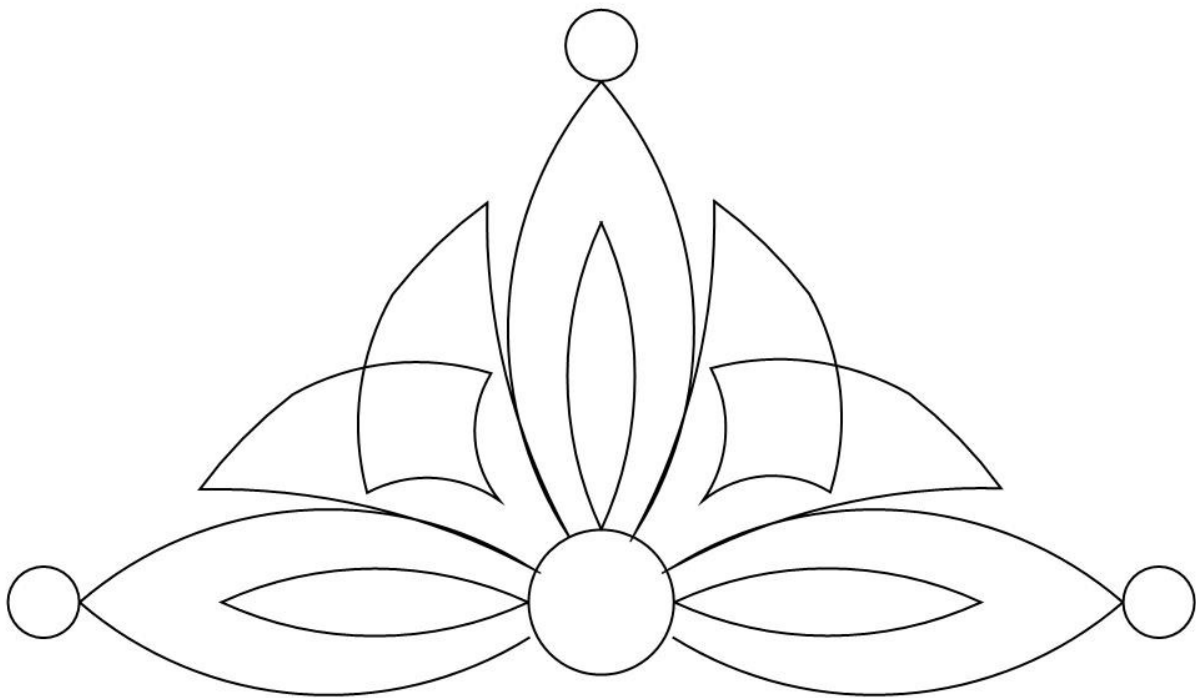

Pattern: beauty tri 001

Archive: Quartz September 2015

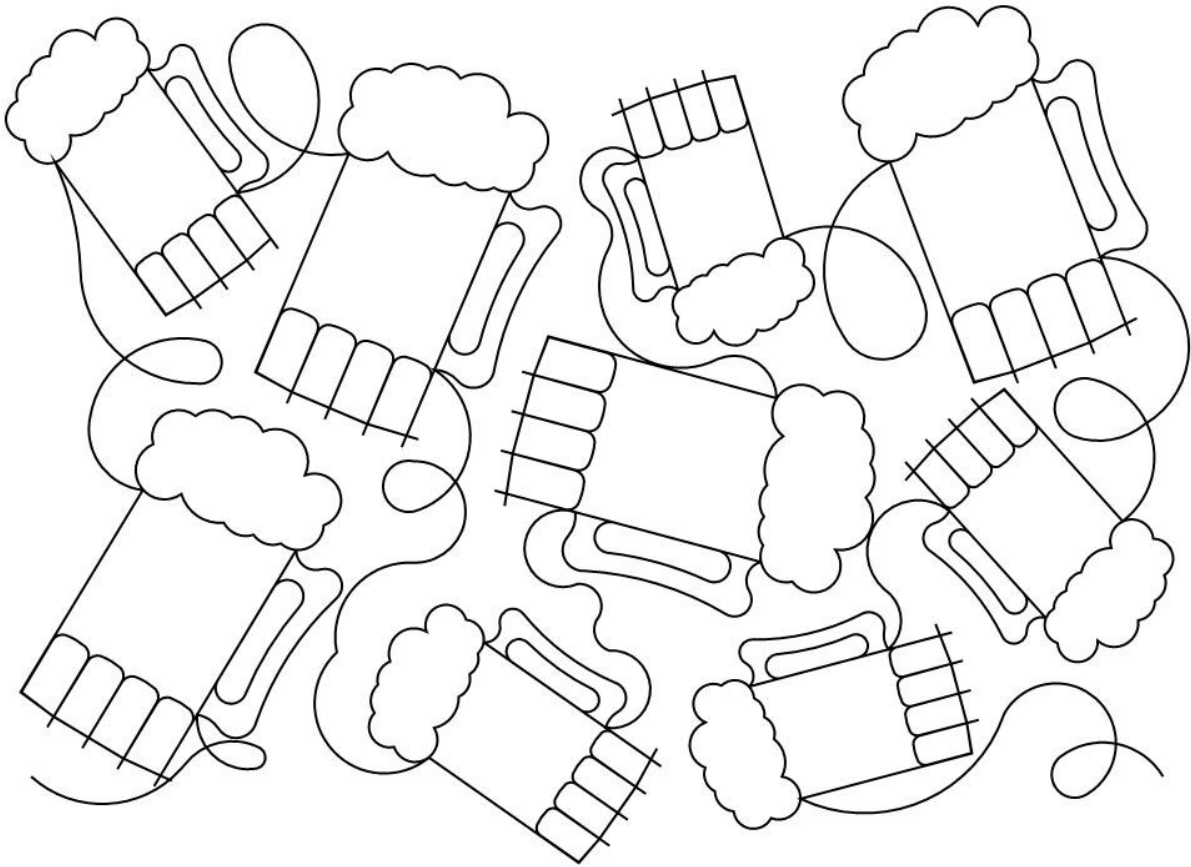

Pattern: beer mug pano 001

Archive: Quartz September 2015



Pattern: bird border 003

Archive: Quartz September 2015



Pattern: bird brd crn 003

Archive: Quartz September 2015



Pattern: buffalo head

Archive: Quartz September 2015

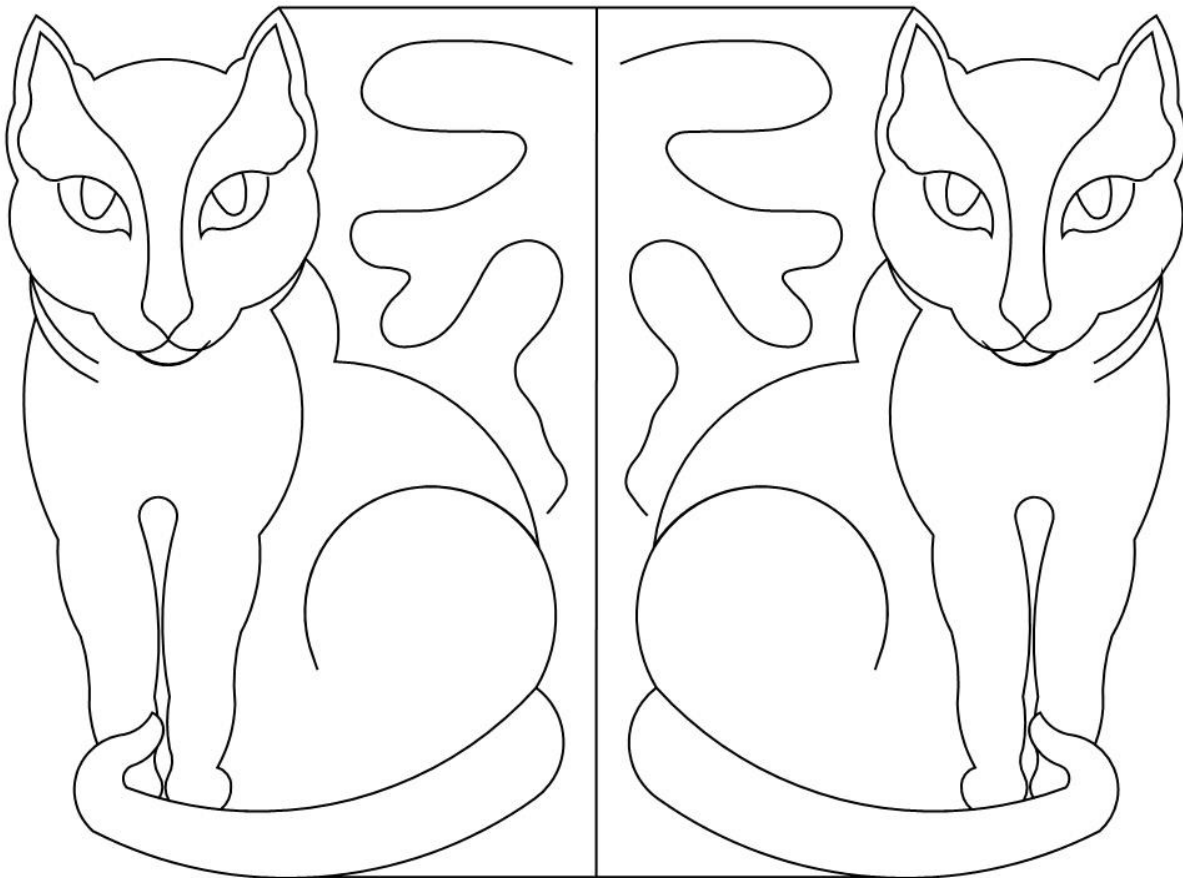

Pattern: cat needle case

Archive: Quartz September 2015

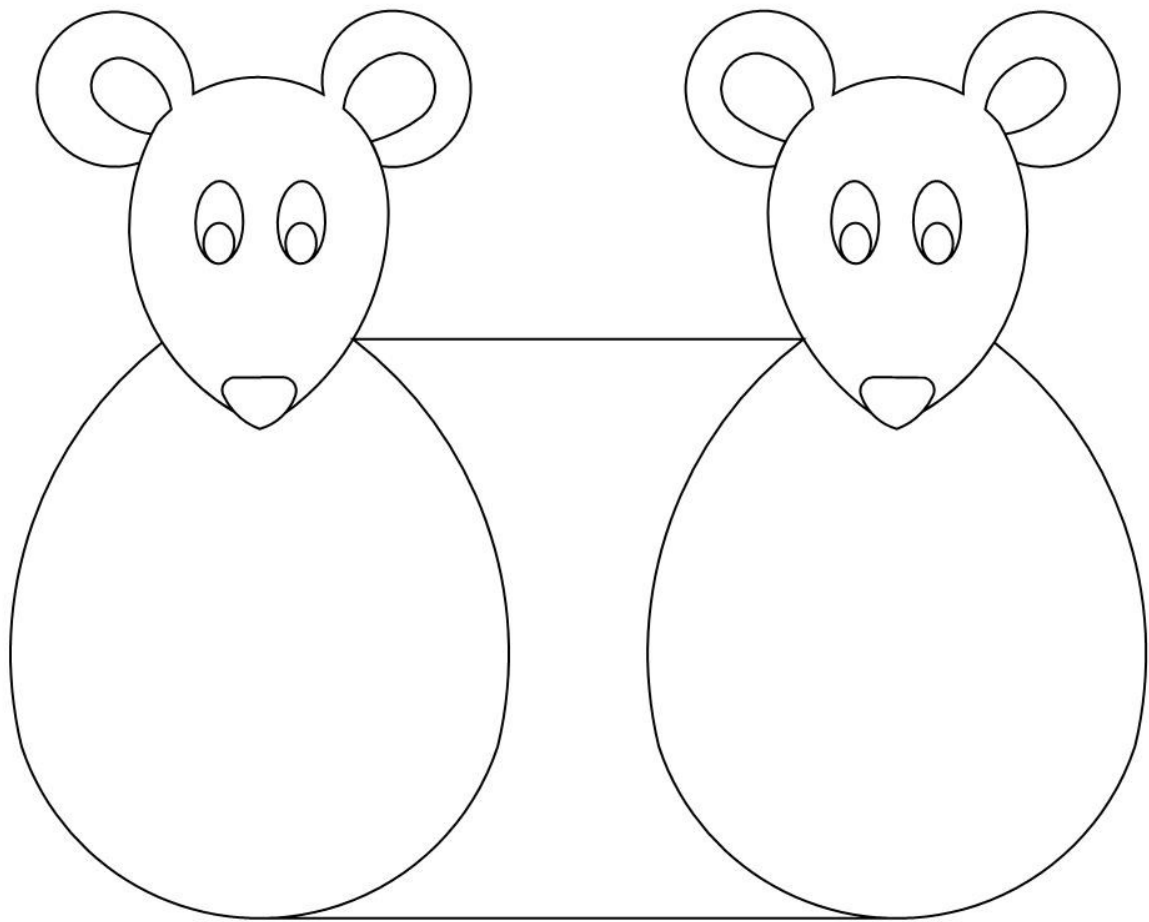

Pattern: cat needle case inside

Archive: Quartz September 2015

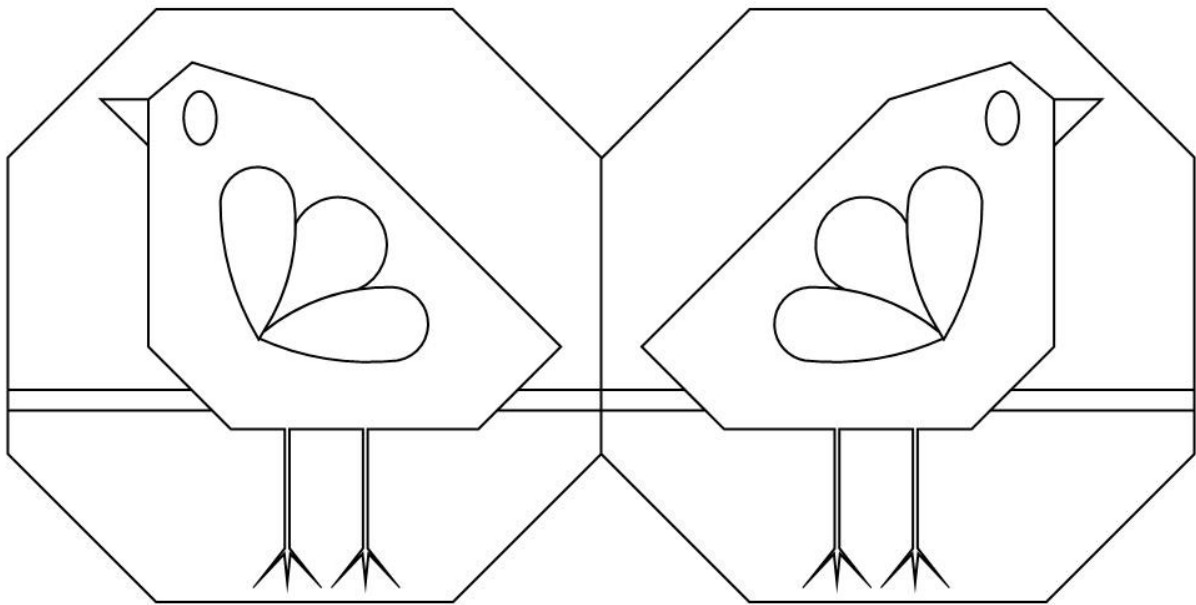

Pattern: chick needlecase

Archive: Quartz September 2015

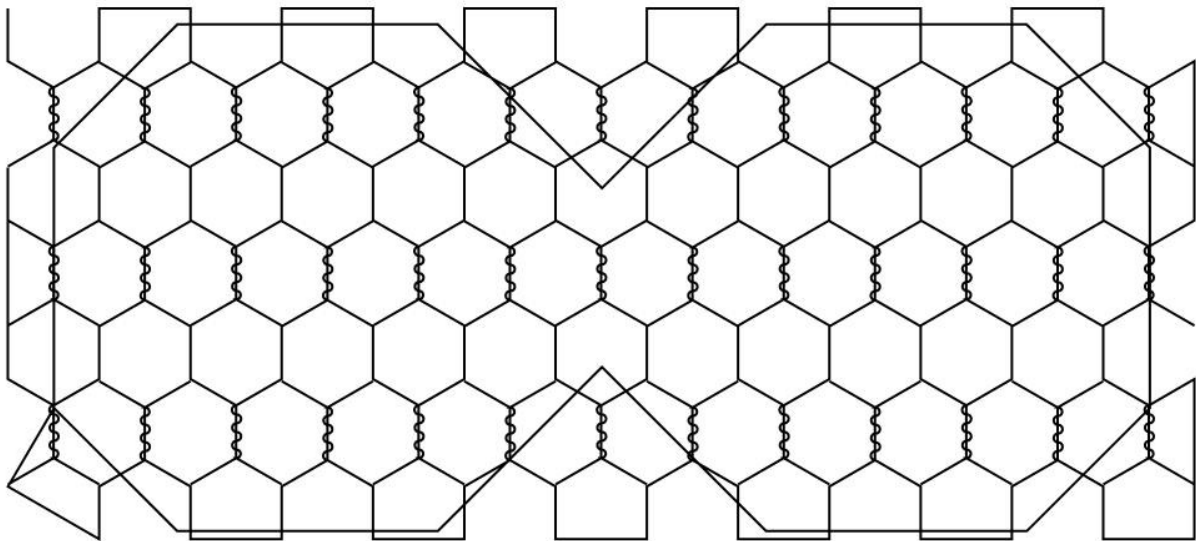

Pattern: chick needlecase inside

Archive: Quartz September 2015

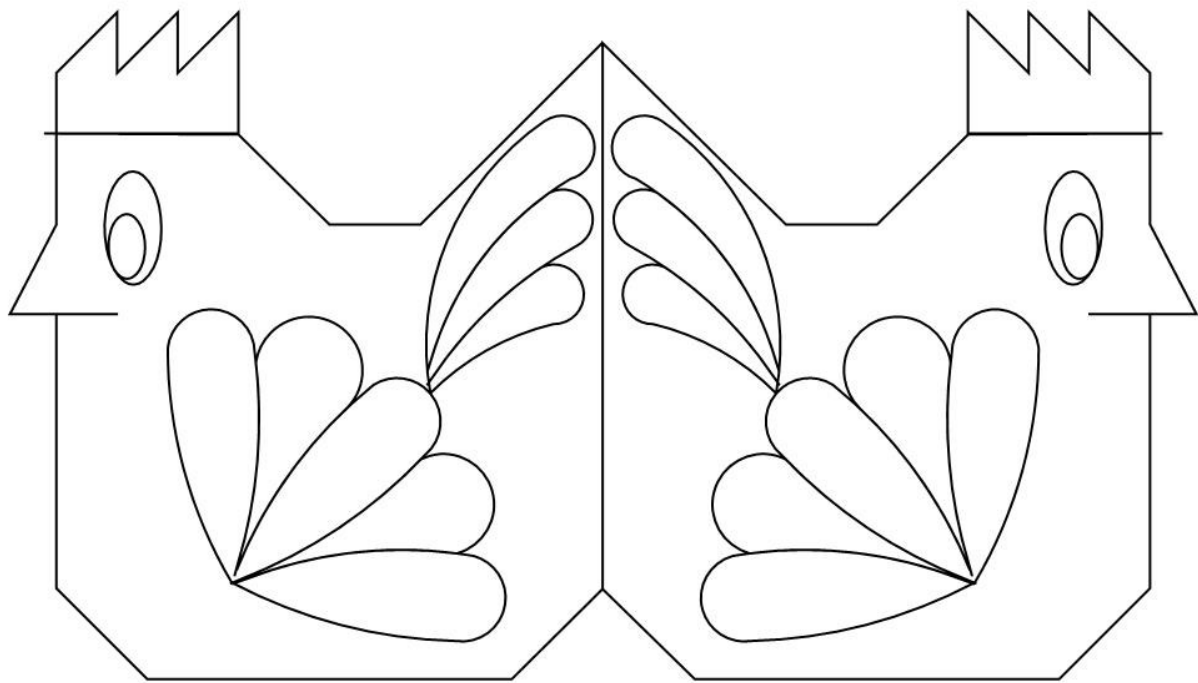

Pattern: chicken needle case

Archive: Quartz September 2015

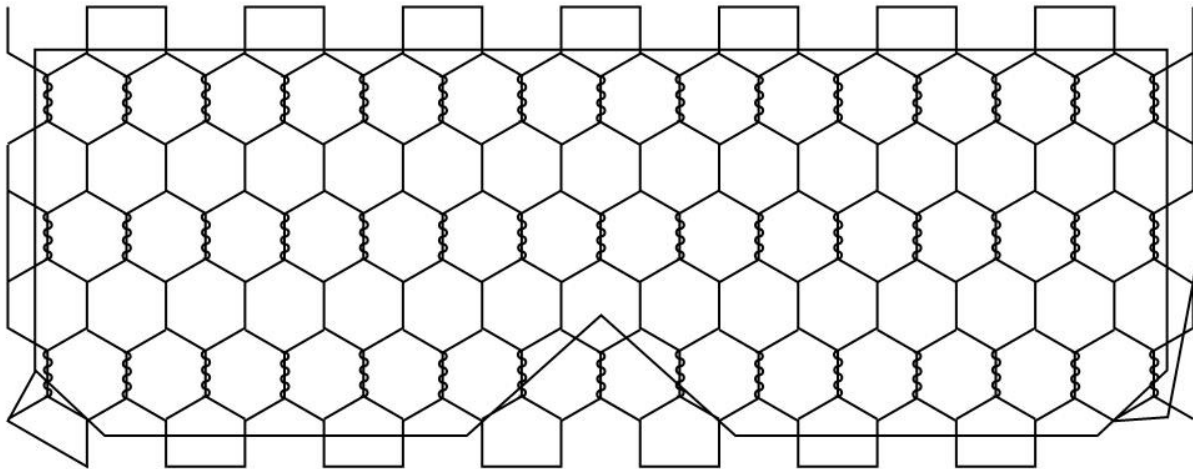

Pattern: chicken needle case inside

Archive: Quartz September 2015

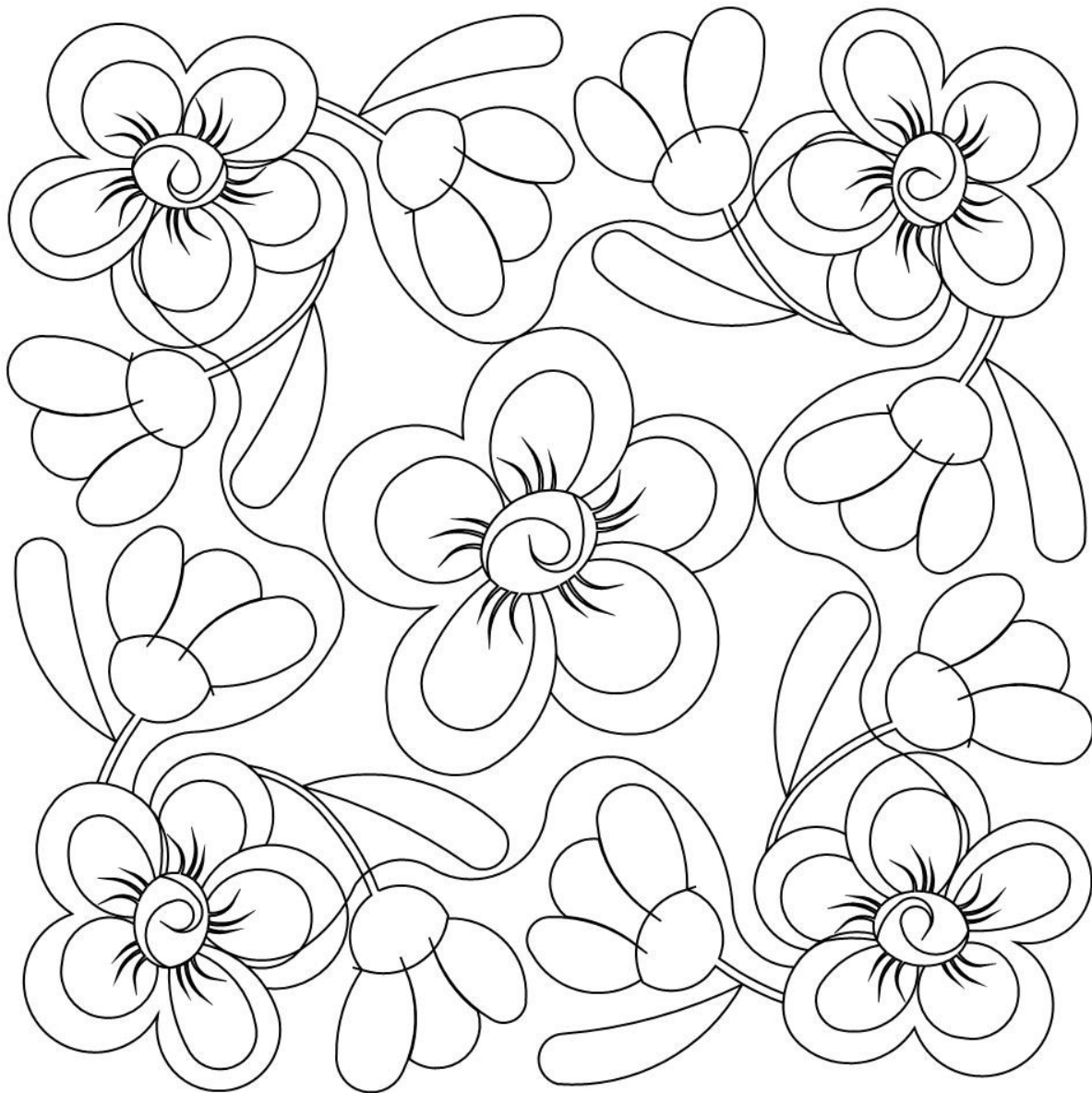

Pattern: cindy flower block 001

Archive: Quartz September 2015

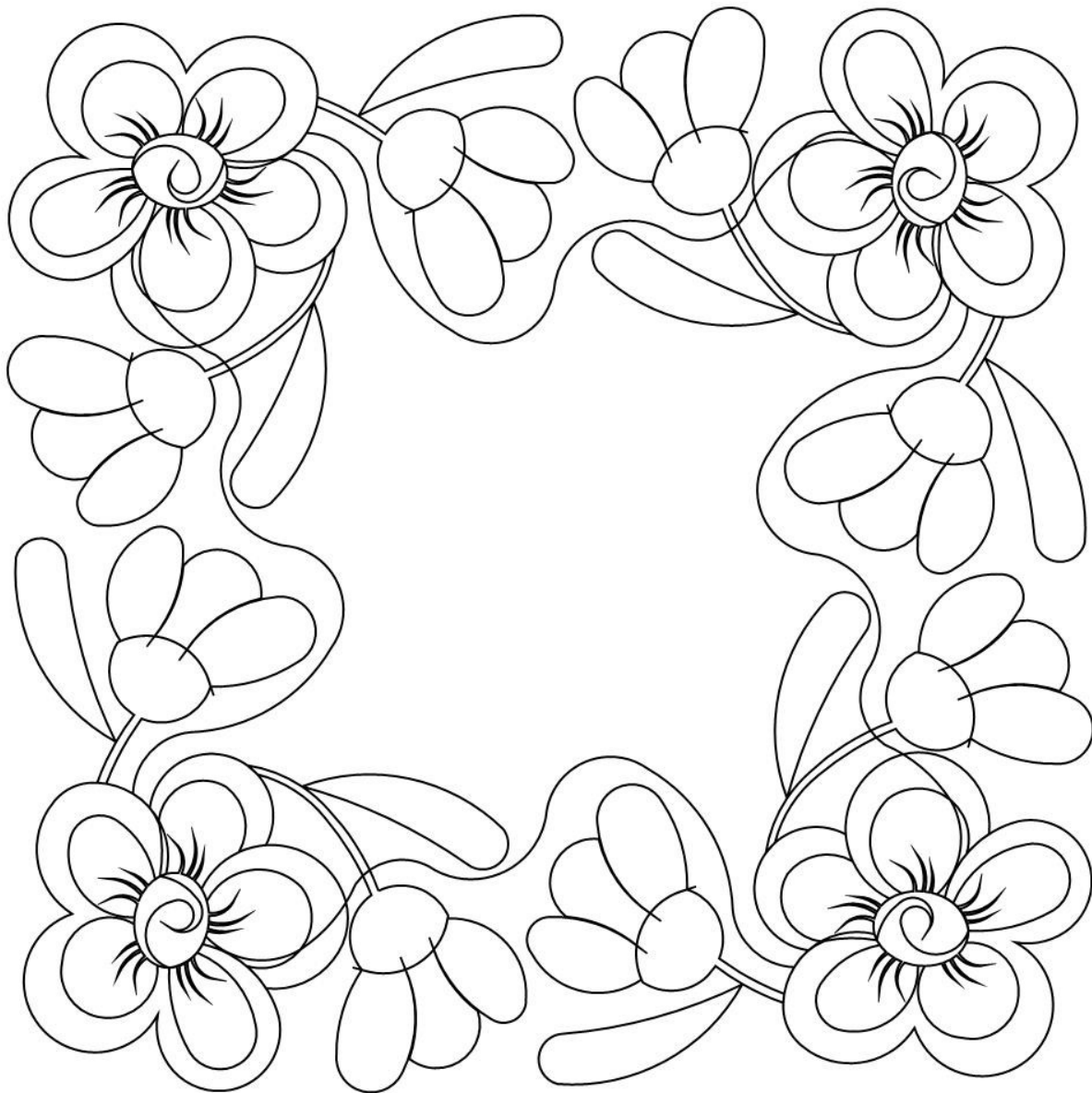

Pattern: cindy flower frame

Archive: Quartz September 2015

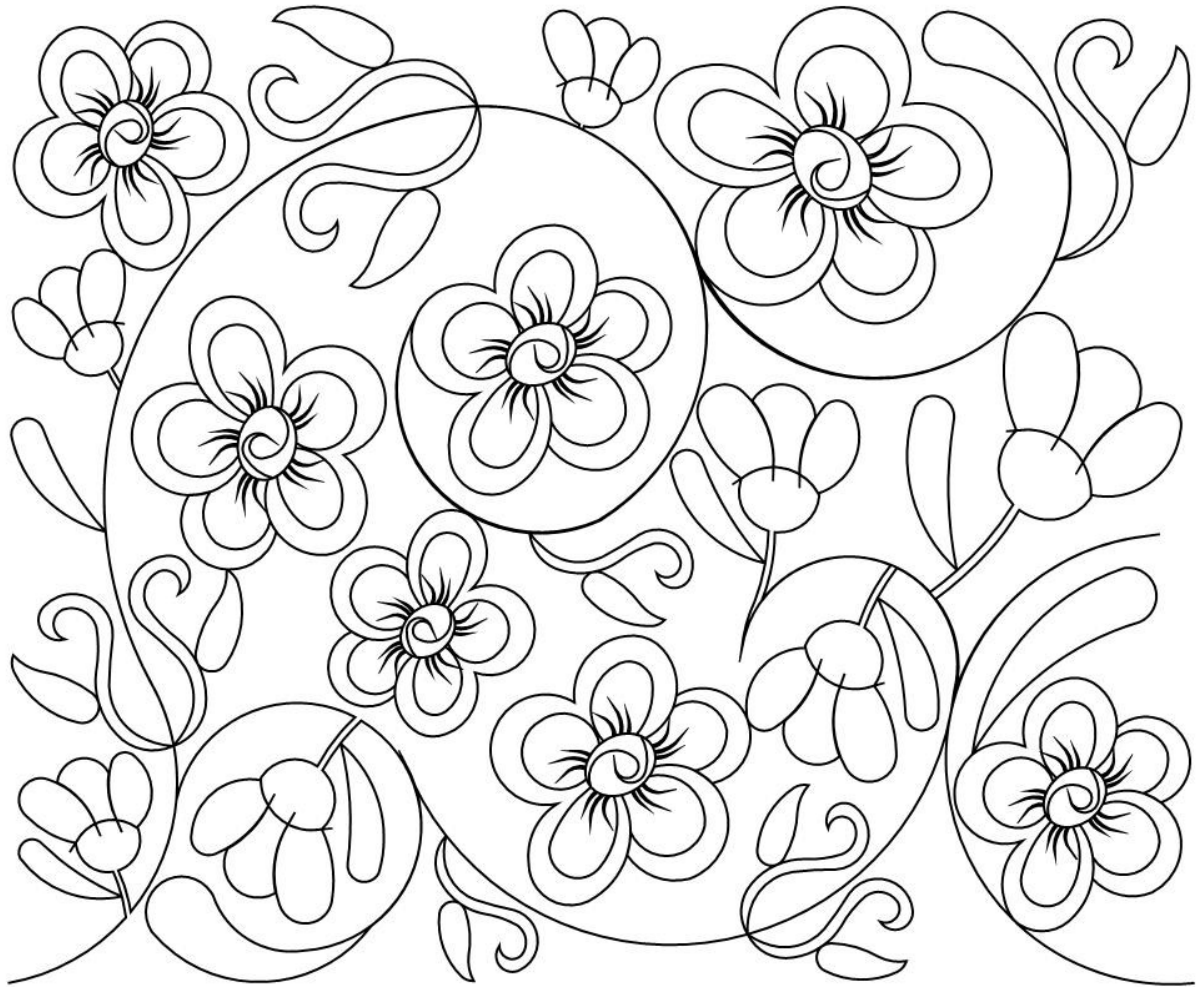

Pattern: cindy flower pano sq 001

Archive: Quartz September 2015

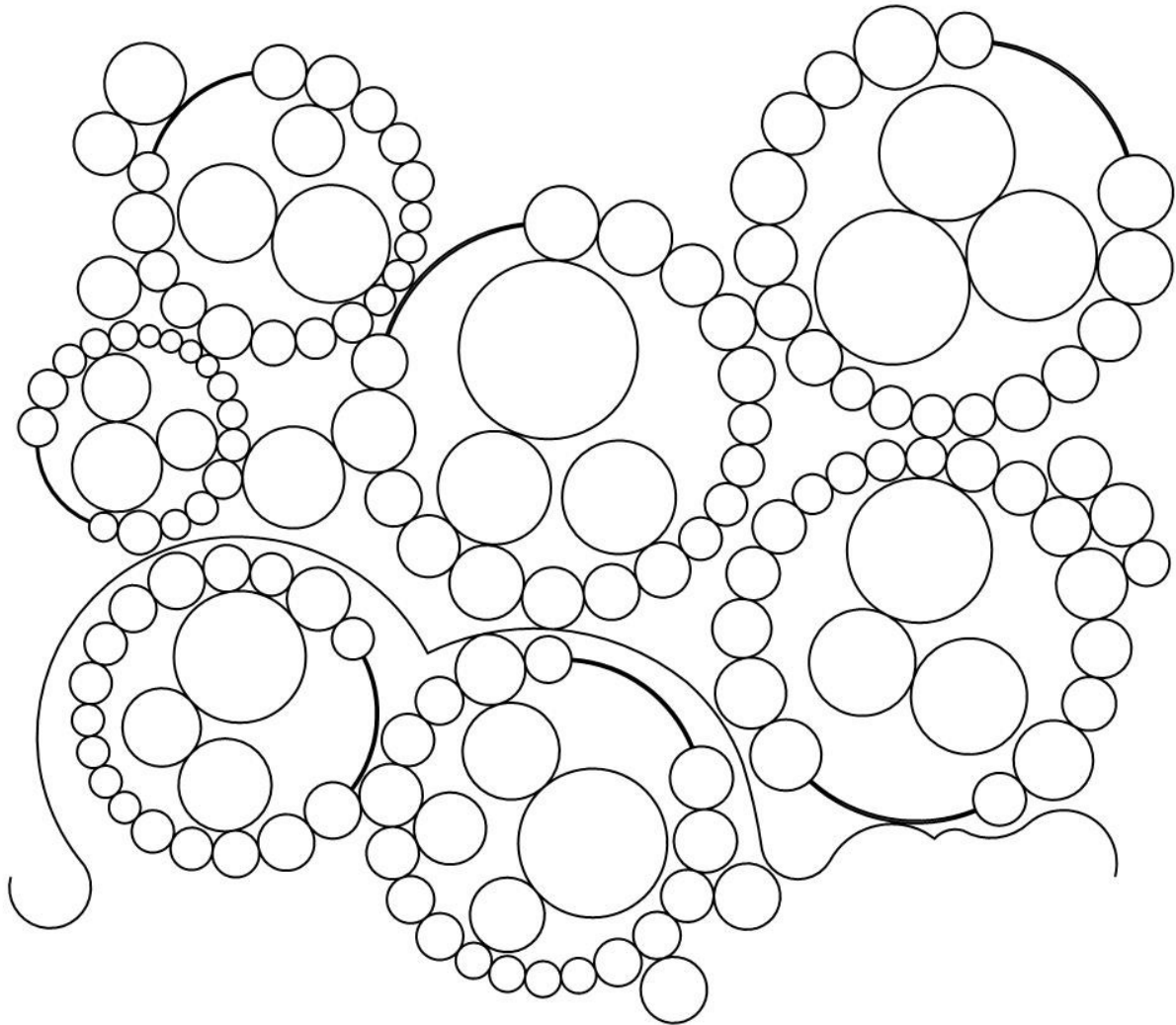

Pattern: circle ring pano 001

Archive: Quartz September 2015



Pattern: climbing vine pano 001

Archive: Quartz September 2015

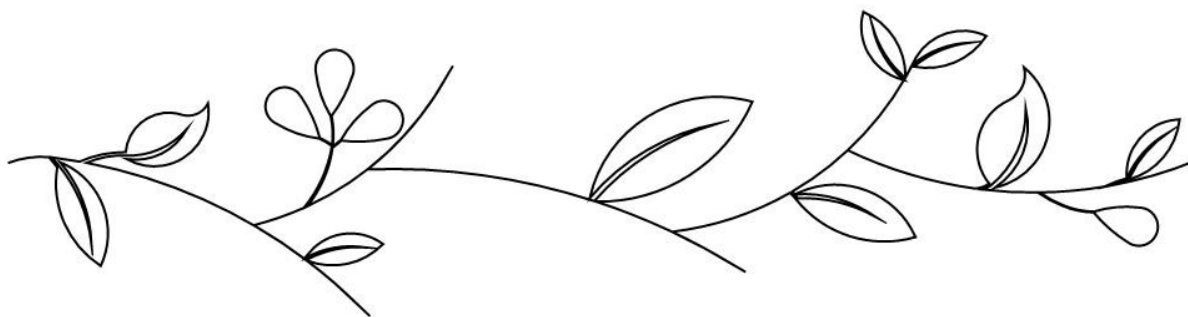

Pattern: climbing vine pano 002

Archive: Quartz September 2015

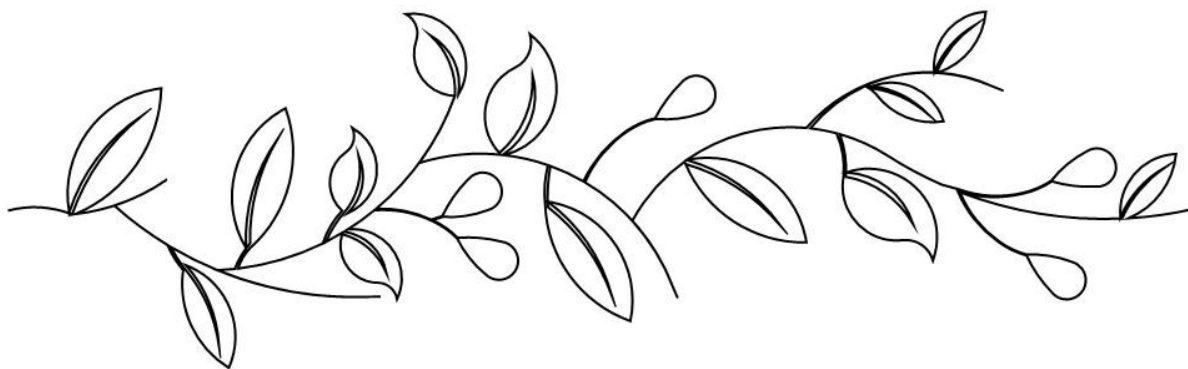

Pattern: climbing vine pano 003

Archive: Quartz September 2015

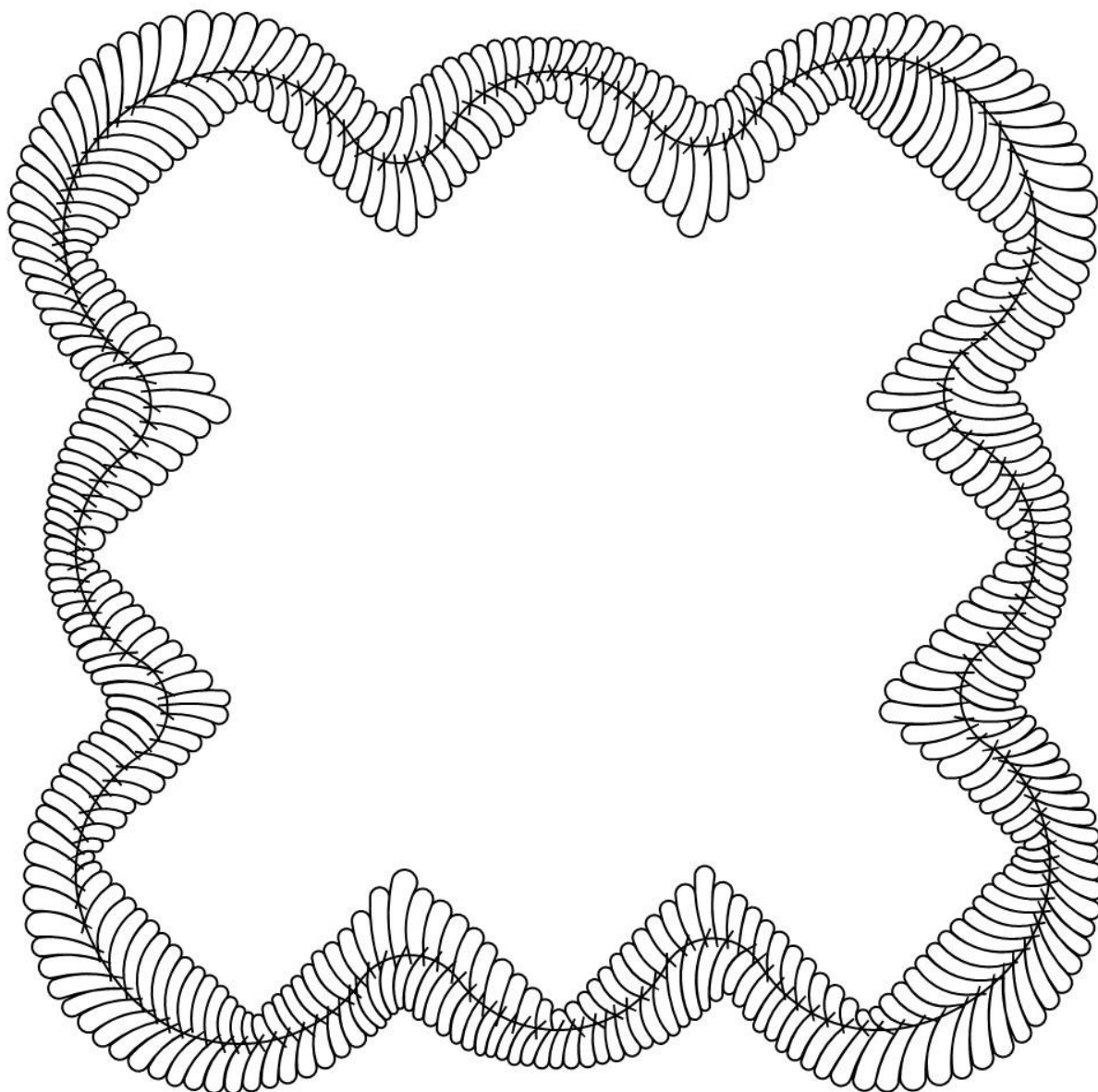

Pattern: dans feather frame 001

Archive: Quartz September 2015

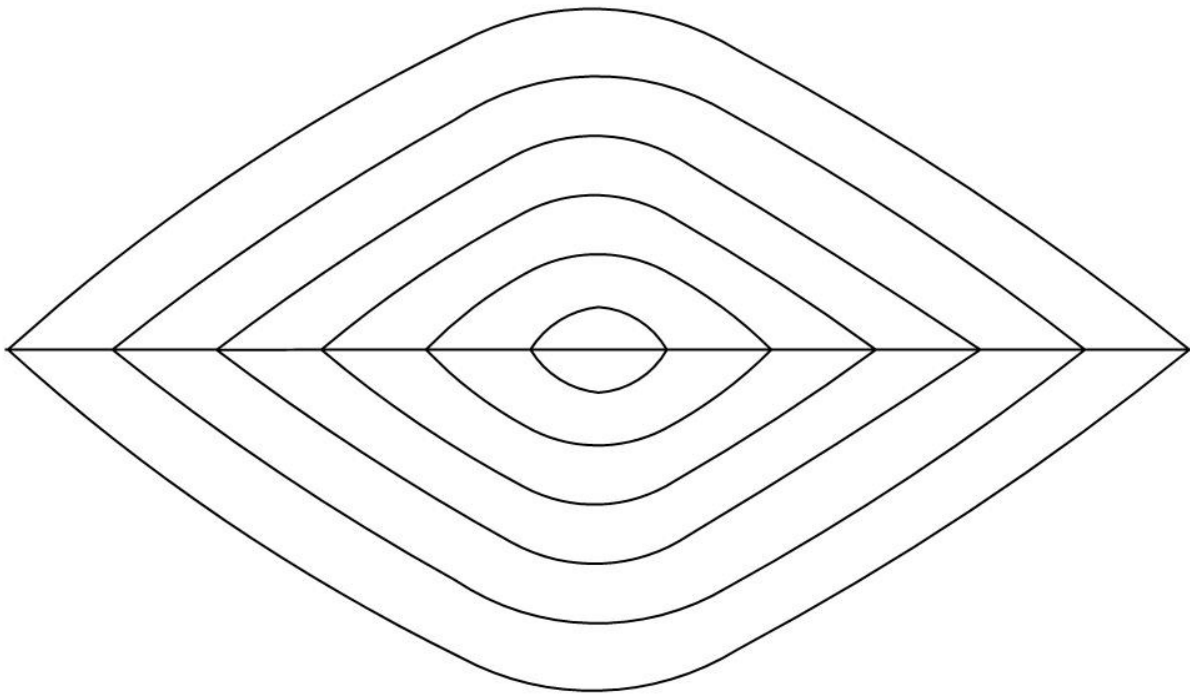

Pattern: diamond alt pano 002

Archive: Quartz September 2015

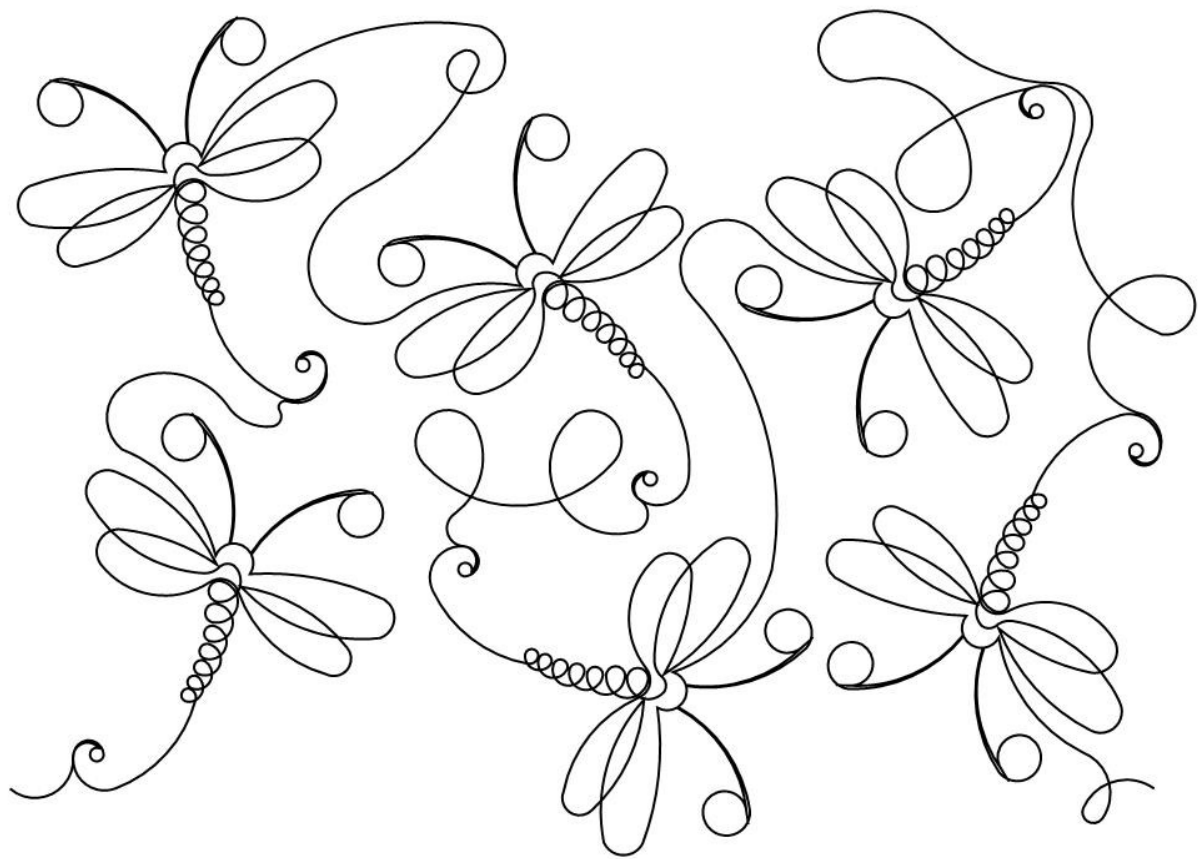

Pattern: dragonfly pano 001

Archive: Quartz September 2015

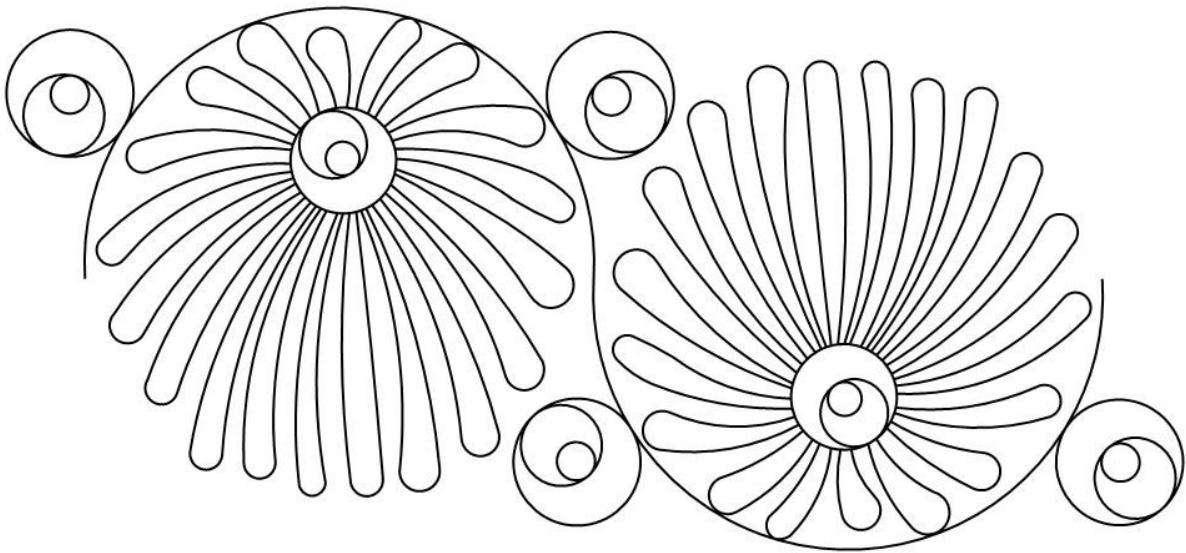

Pattern: drippy flower pano 001

Archive: Quartz September 2015

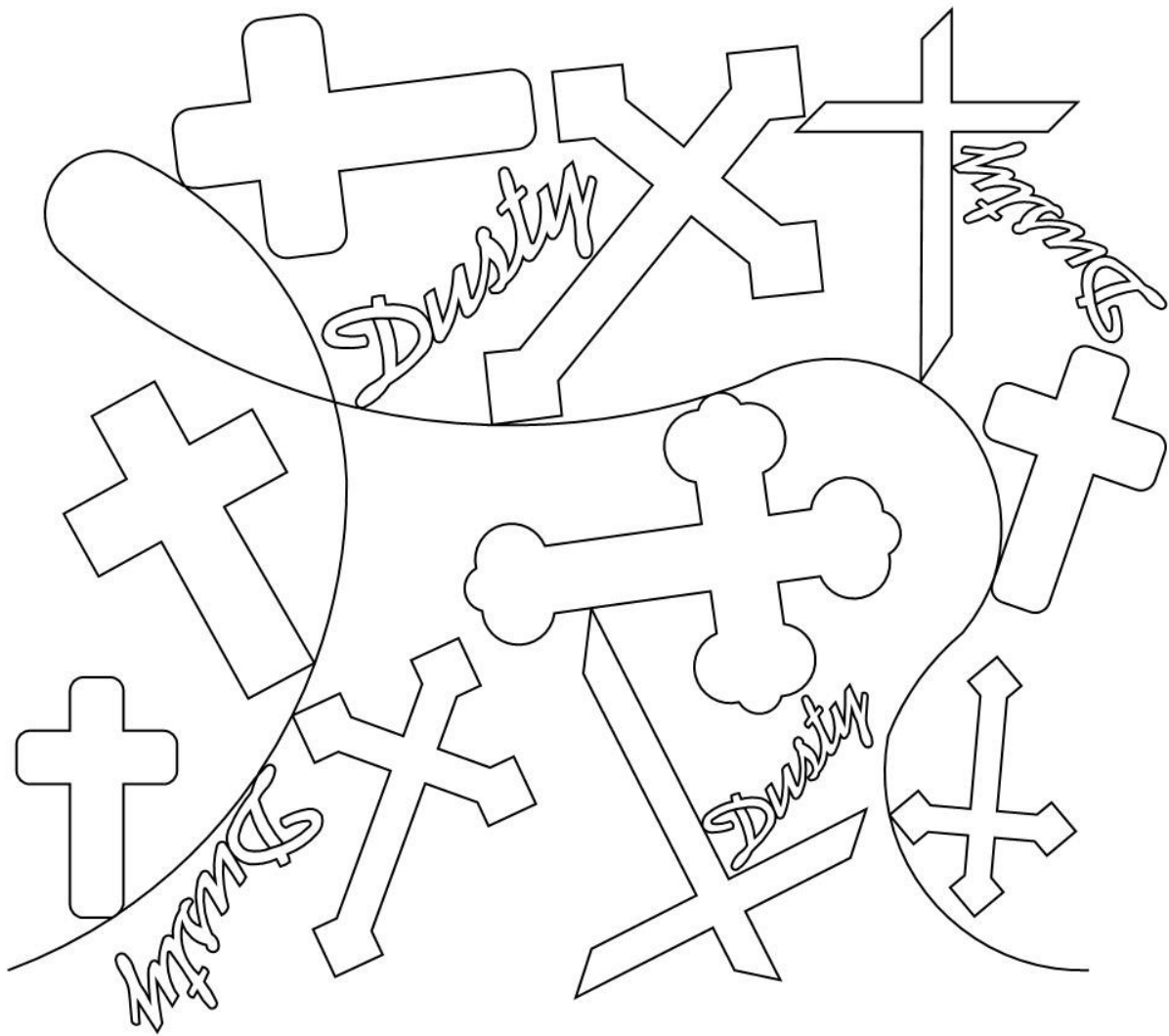

Pattern: dusty crosses pano

Archive: Quartz September 2015

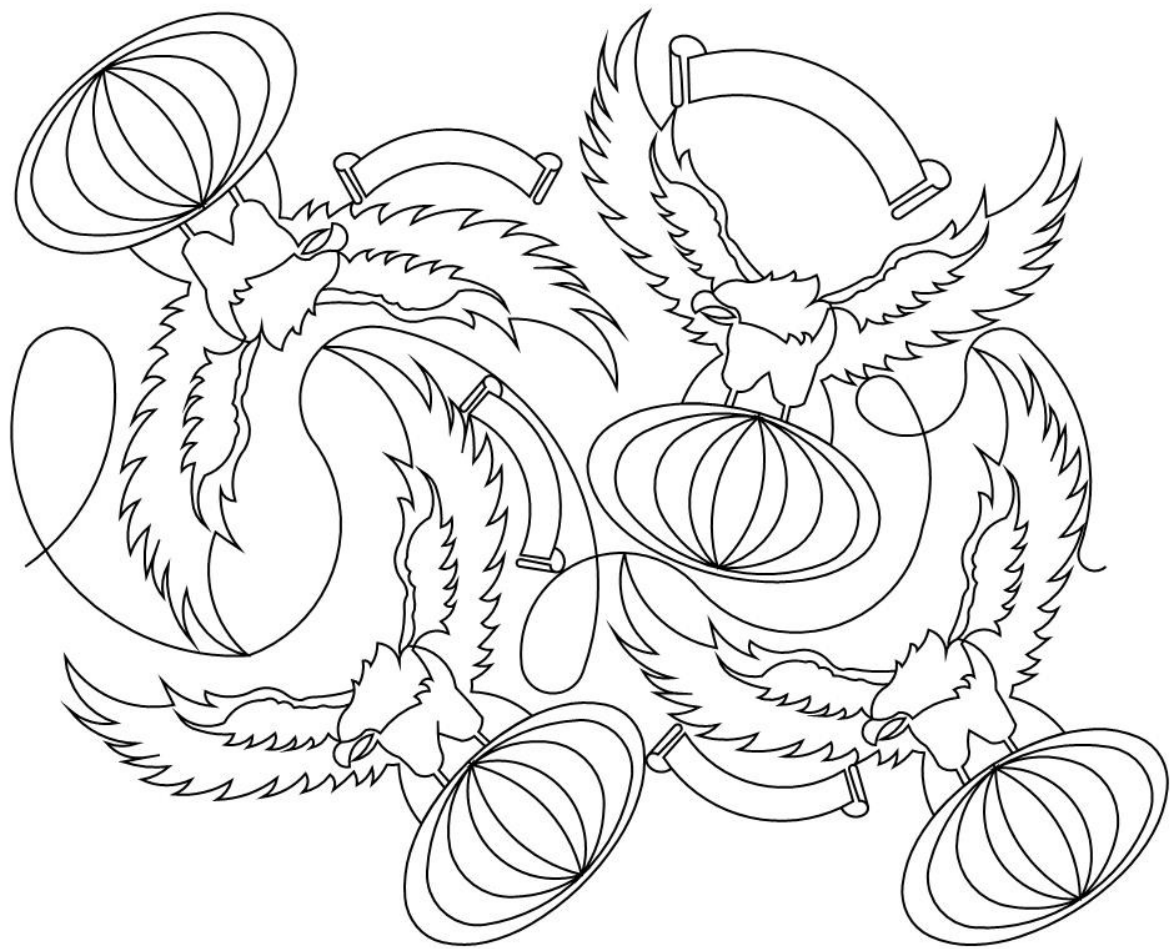

Pattern: eagle world pano 001

Archive: Quartz September 2015

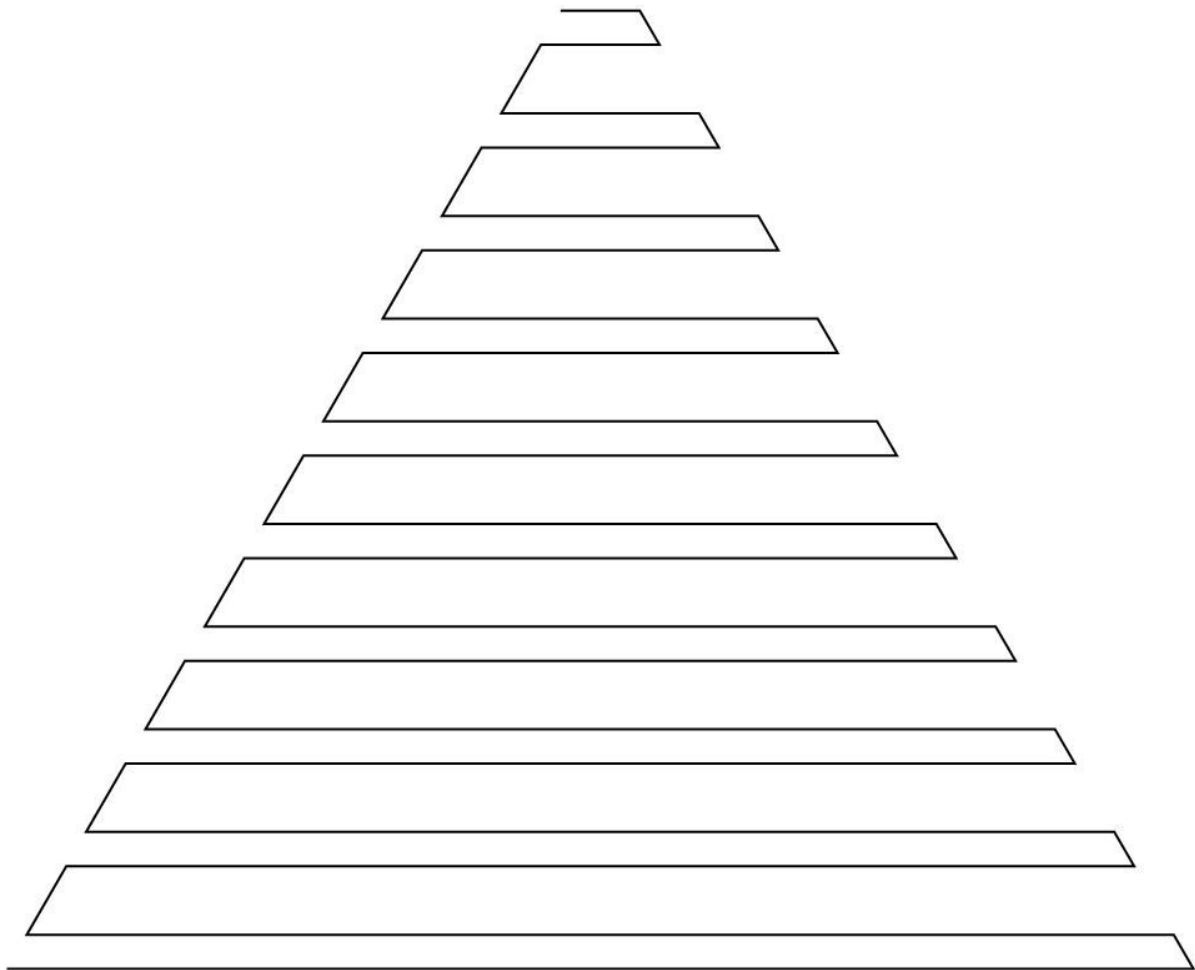

Pattern: eq tri 001

Archive: Quartz September 2015

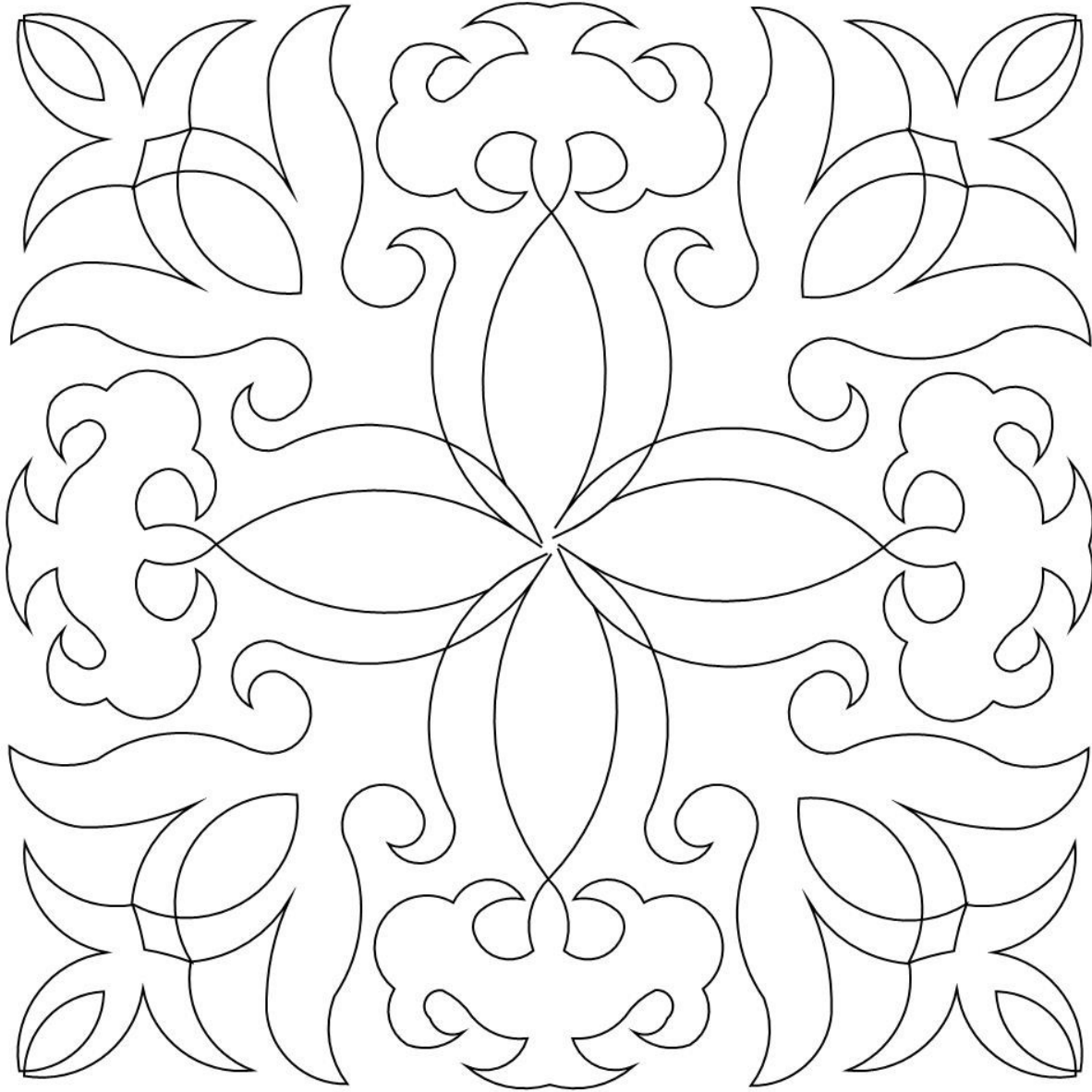

Pattern: fairmont block 004

Archive: Quartz September 2015

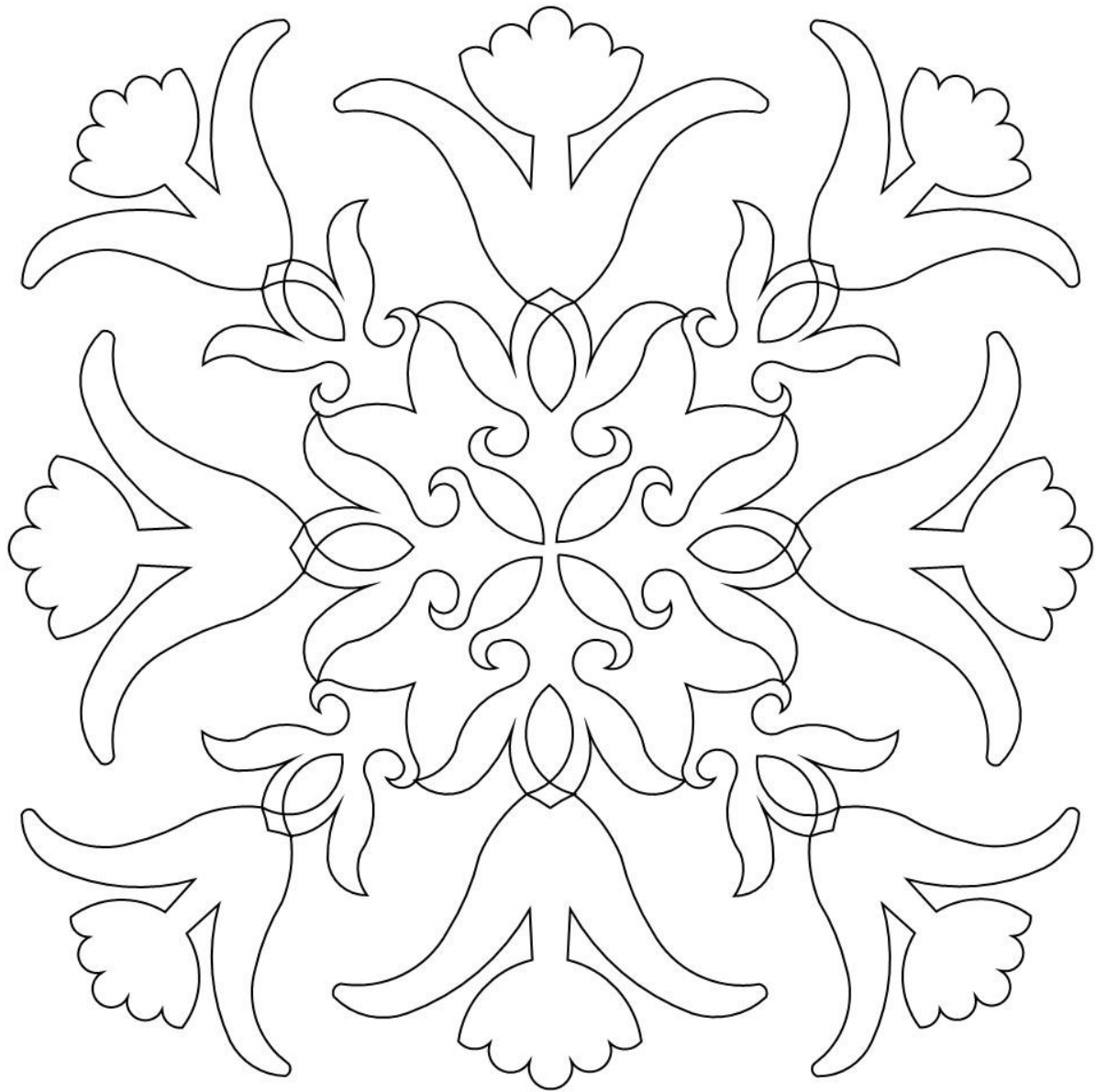

Pattern: fairmont block 005

Archive: Quartz September 2015

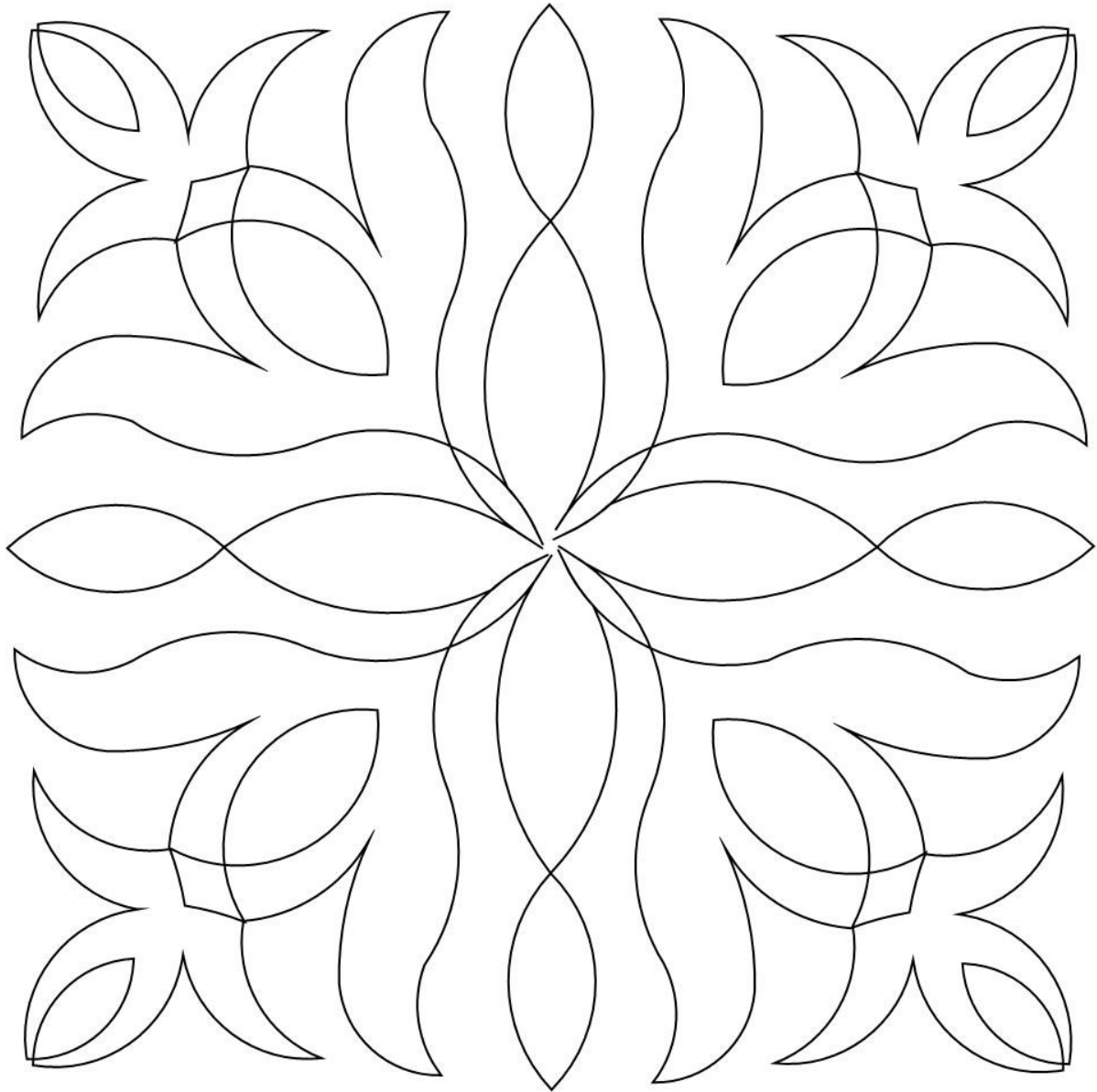

Pattern: fairmont block 006

Archive: Quartz September 2015

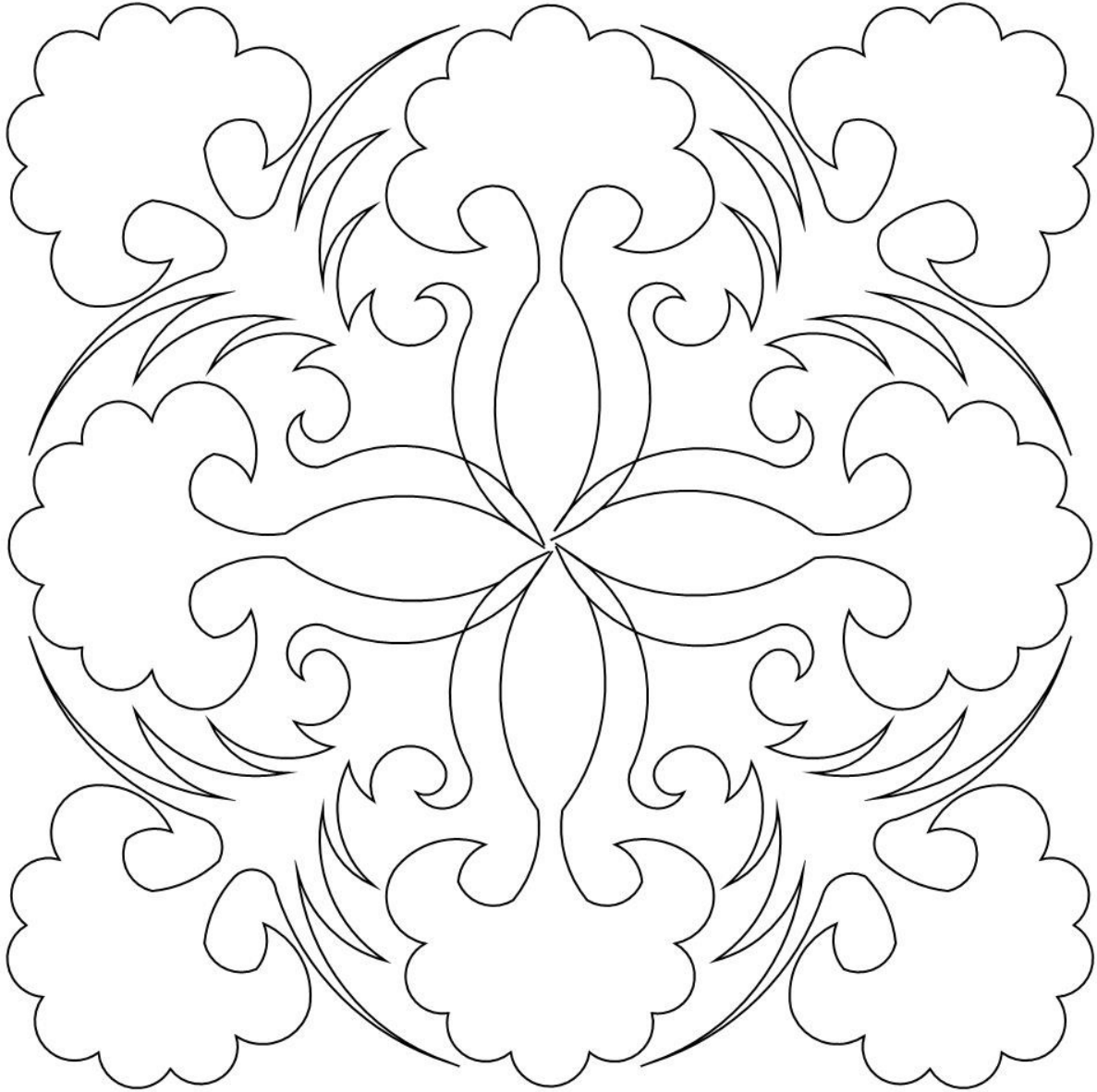

Pattern: fairmont block 007

Archive: Quartz September 2015

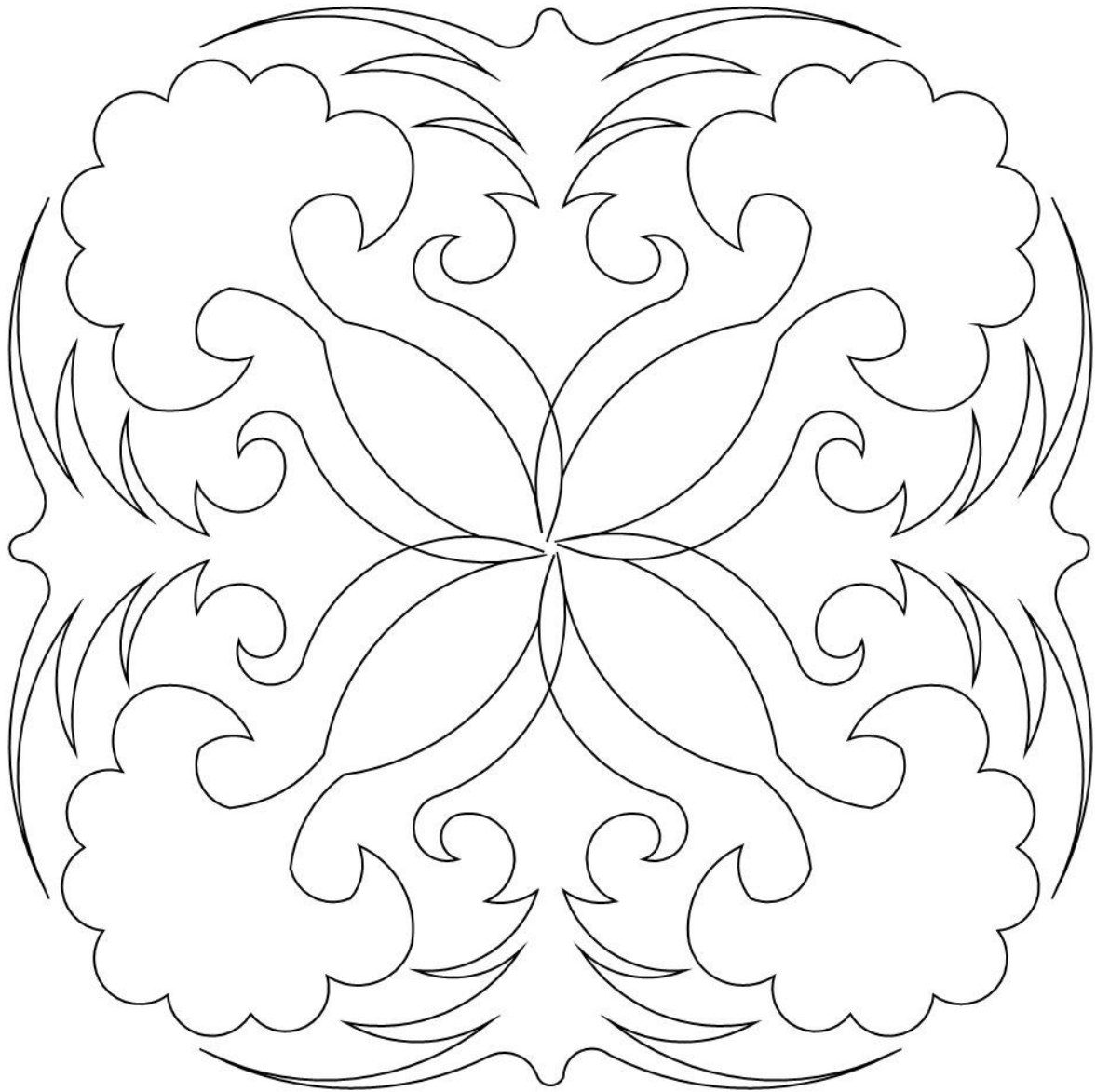

Pattern: fairmont block 008

Archive: Quartz September 2015

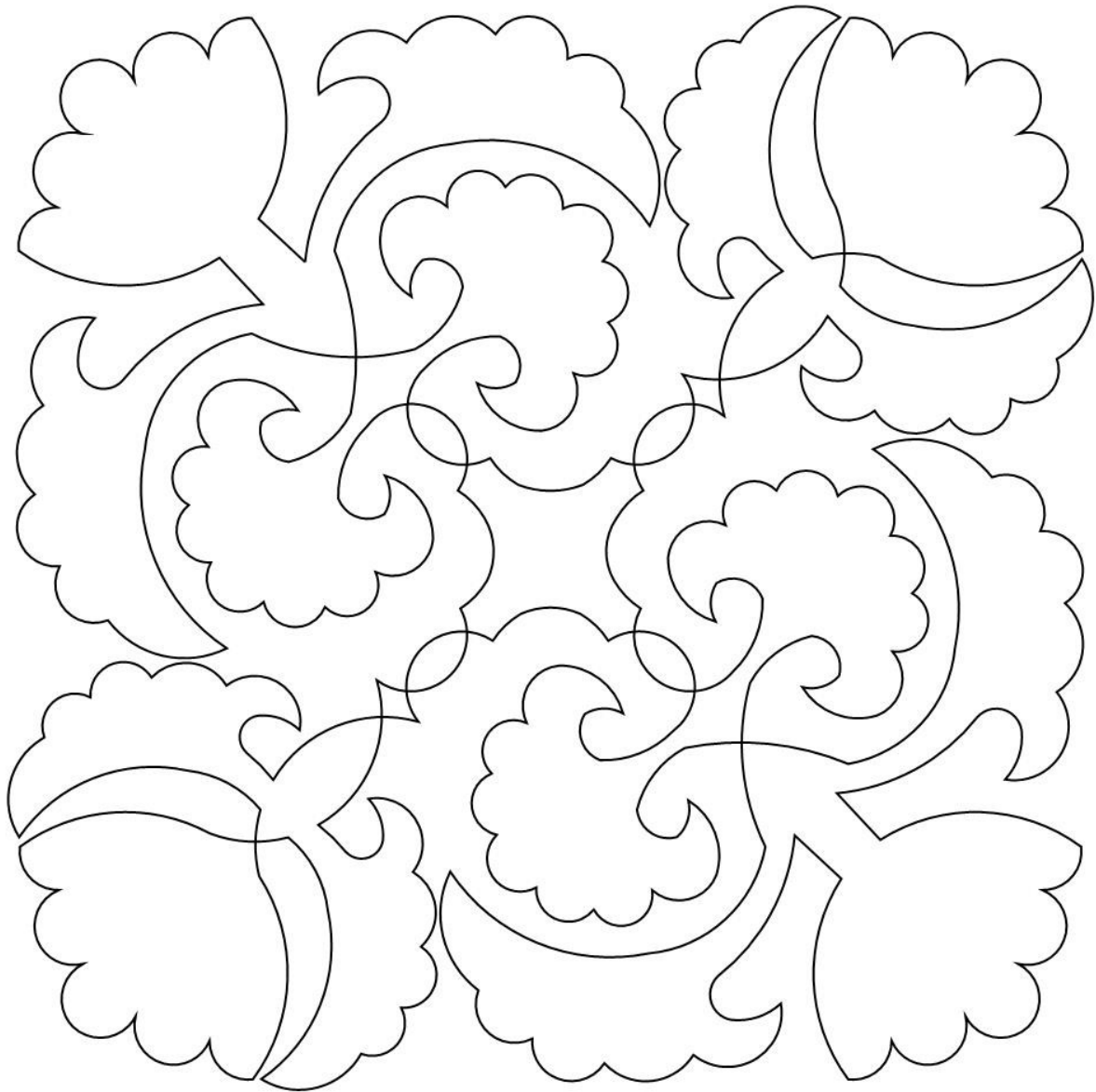

Pattern: fairmont block 009

Archive: Quartz September 2015

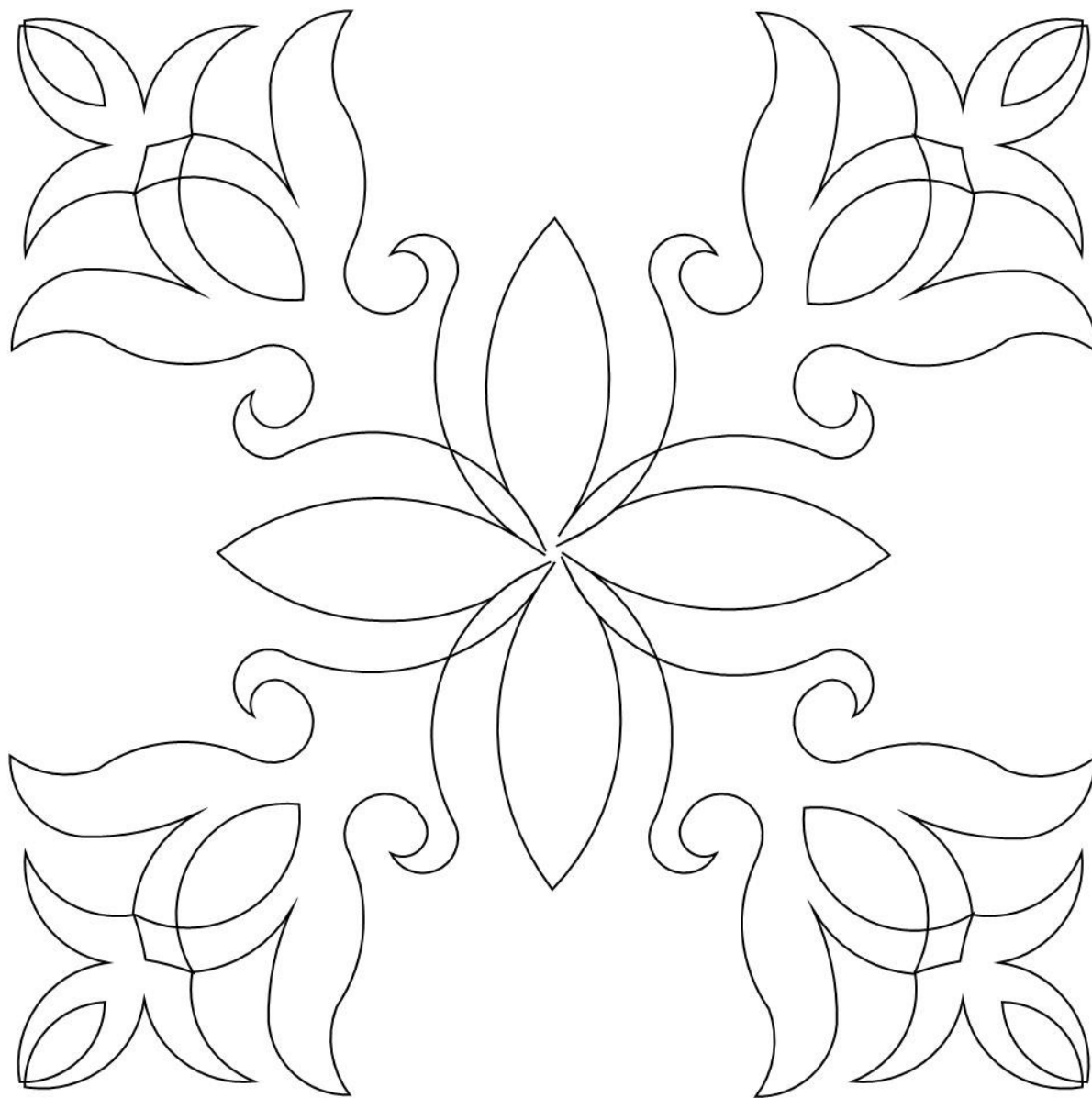

Pattern: fairmont block 010

Archive: Quartz September 2015

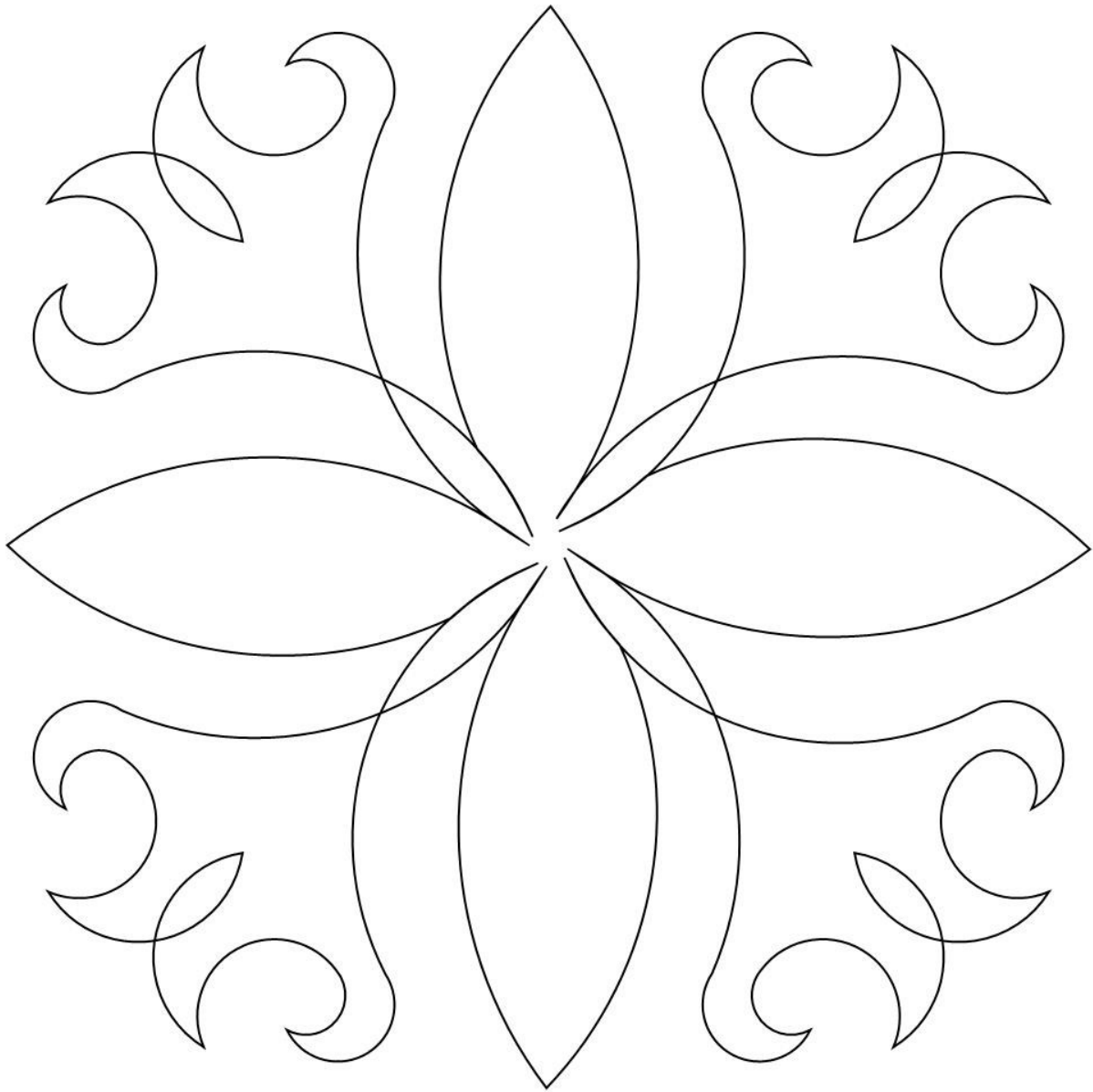

Pattern: fairmont block 011

Archive: Quartz September 2015

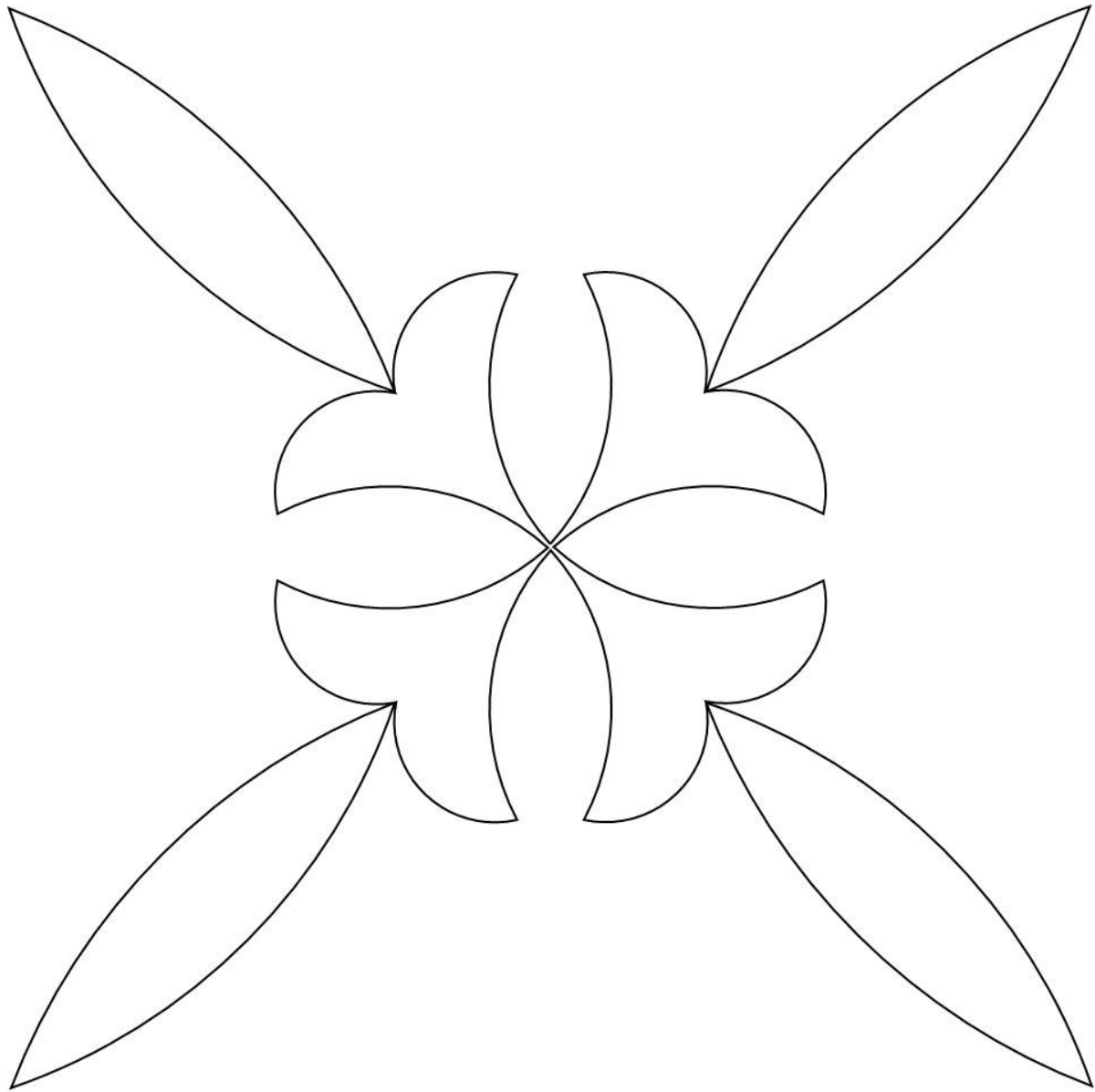

Pattern: fairmont block 012

Archive: Quartz September 2015

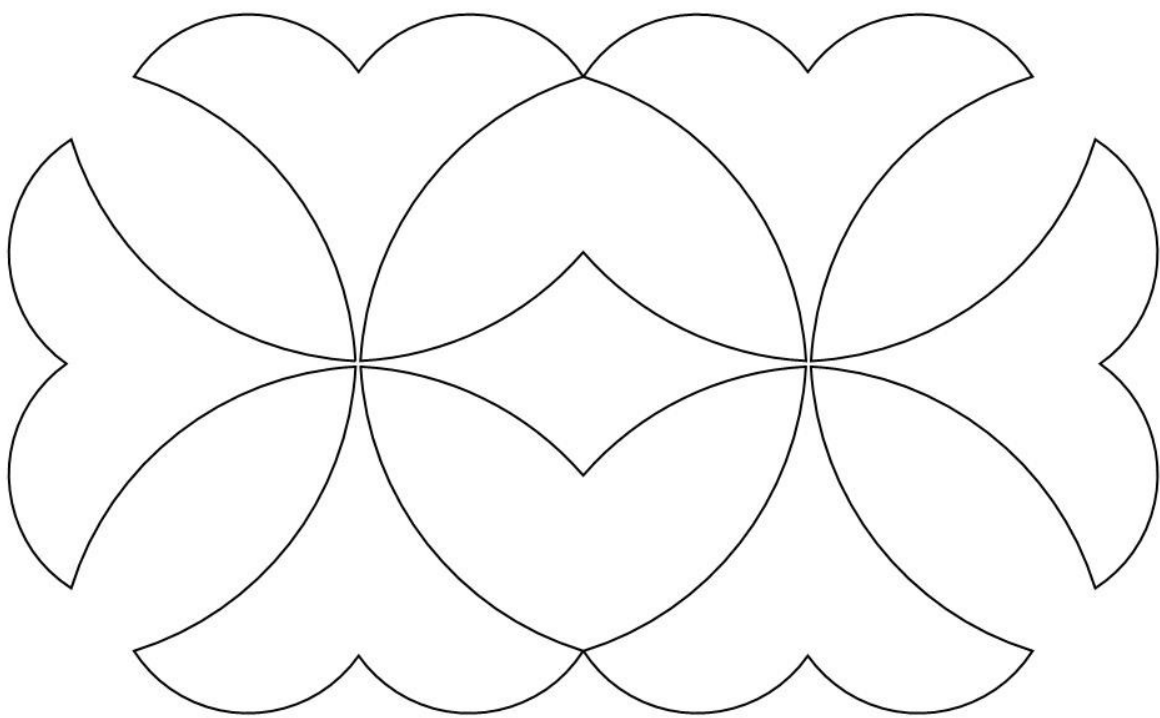

Pattern: fairmont sash 002

Archive: Quartz September 2015

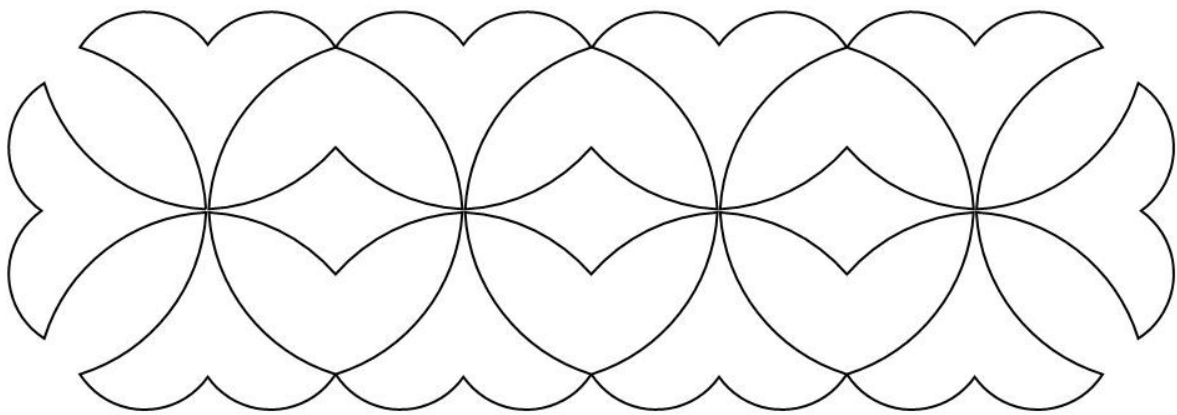

Pattern: fairmont sash 003

Archive: Quartz September 2015

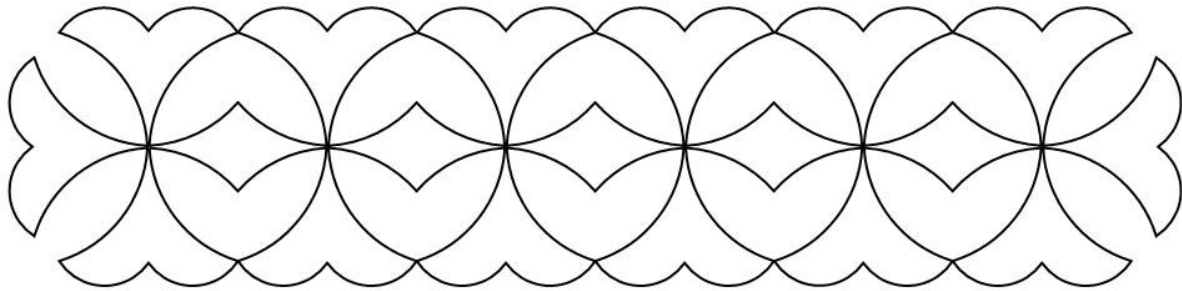

Pattern: fairmont sash 004

Archive: Quartz September 2015

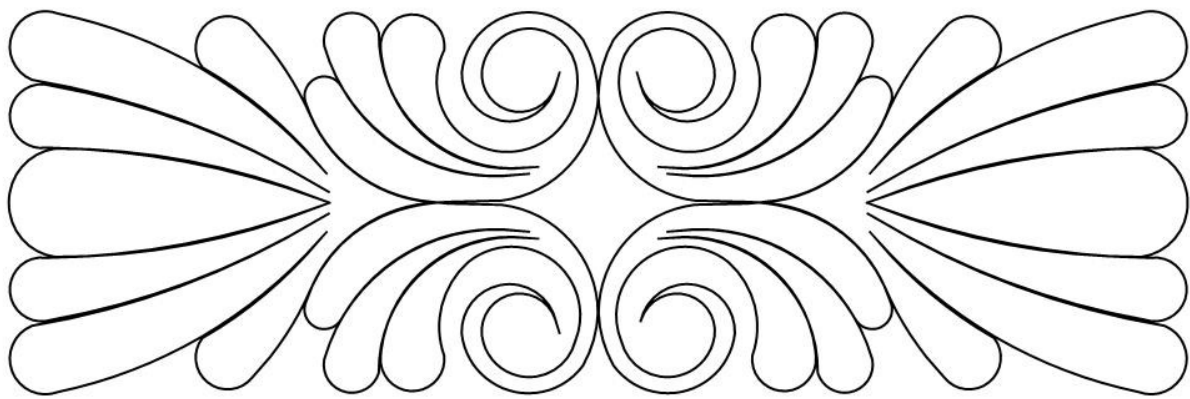

Pattern: feather element 021 rec

Archive: Quartz September 2015

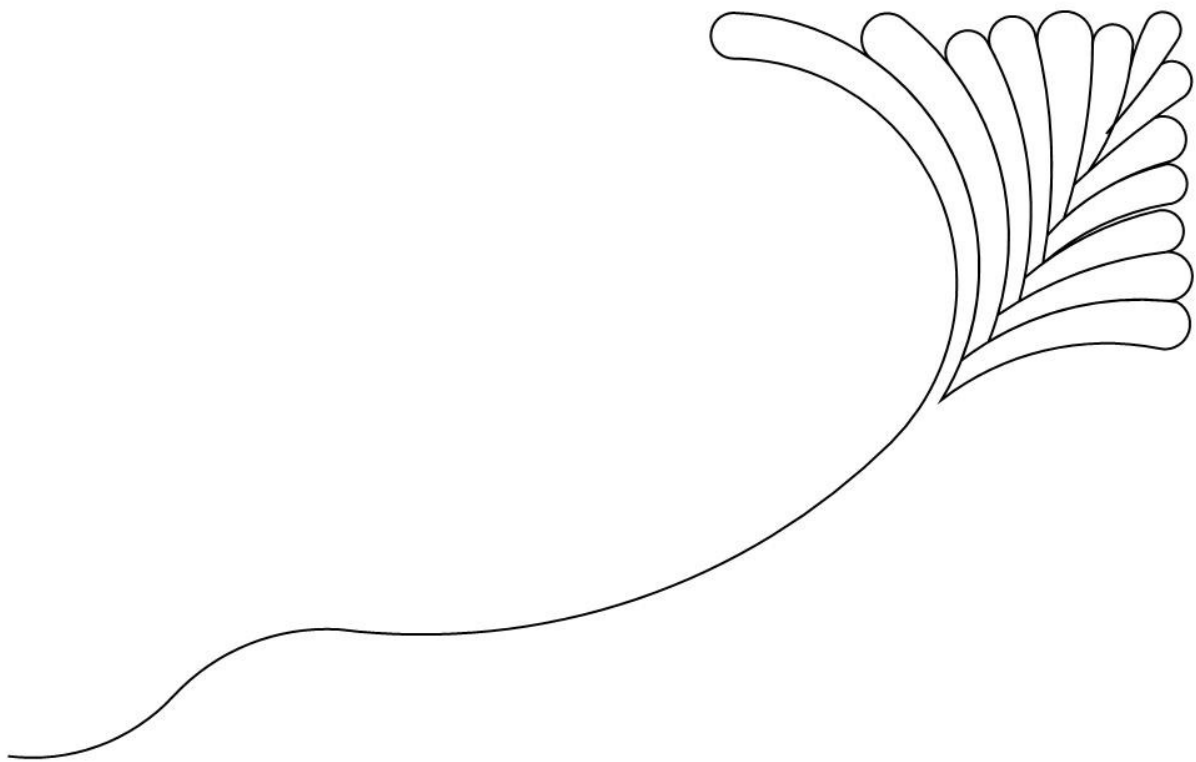

Pattern: feather element 045

Archive: Quartz September 2015

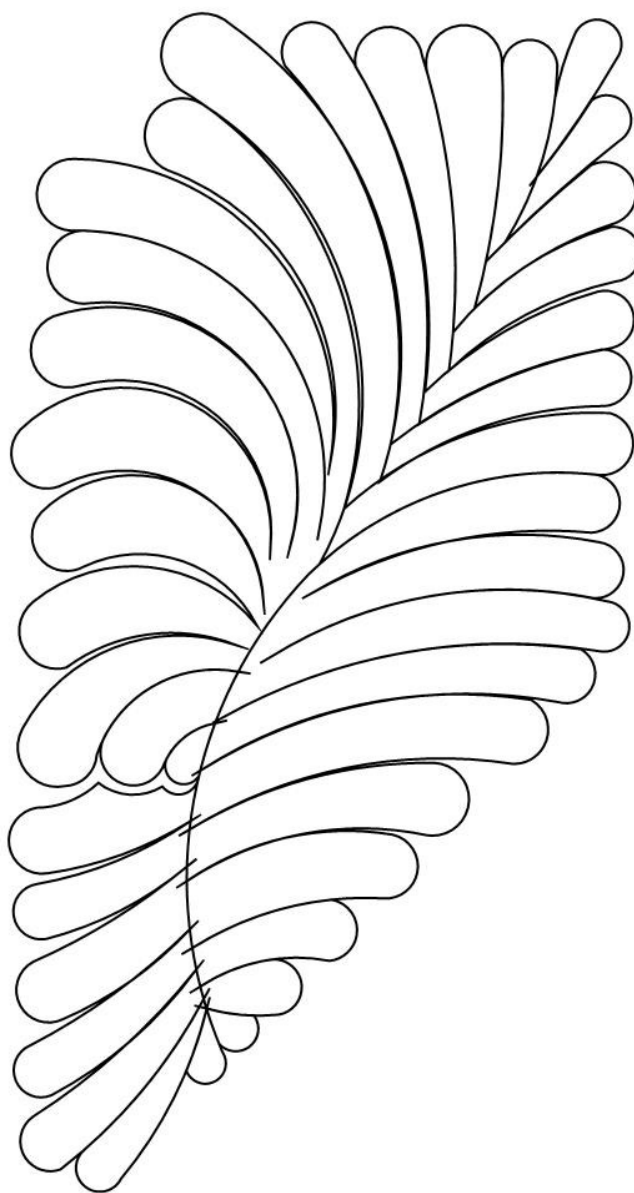

Pattern: feather element 046

Archive: Quartz September 2015

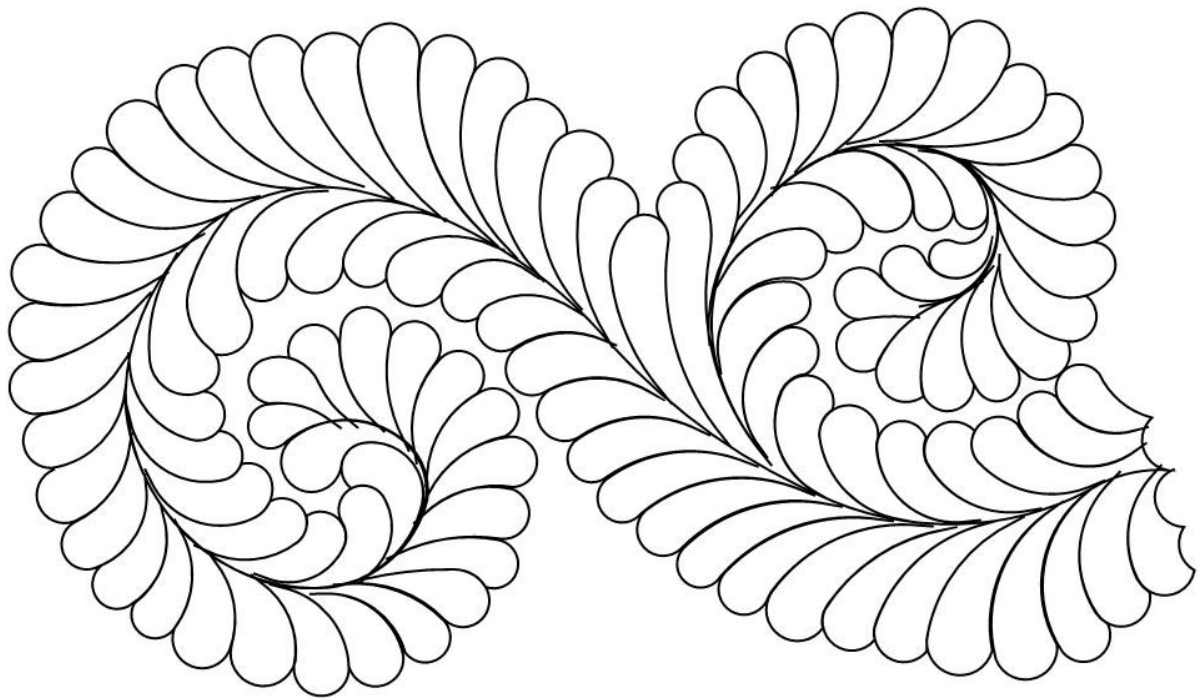

Pattern: feather large border

Archive: Quartz September 2015

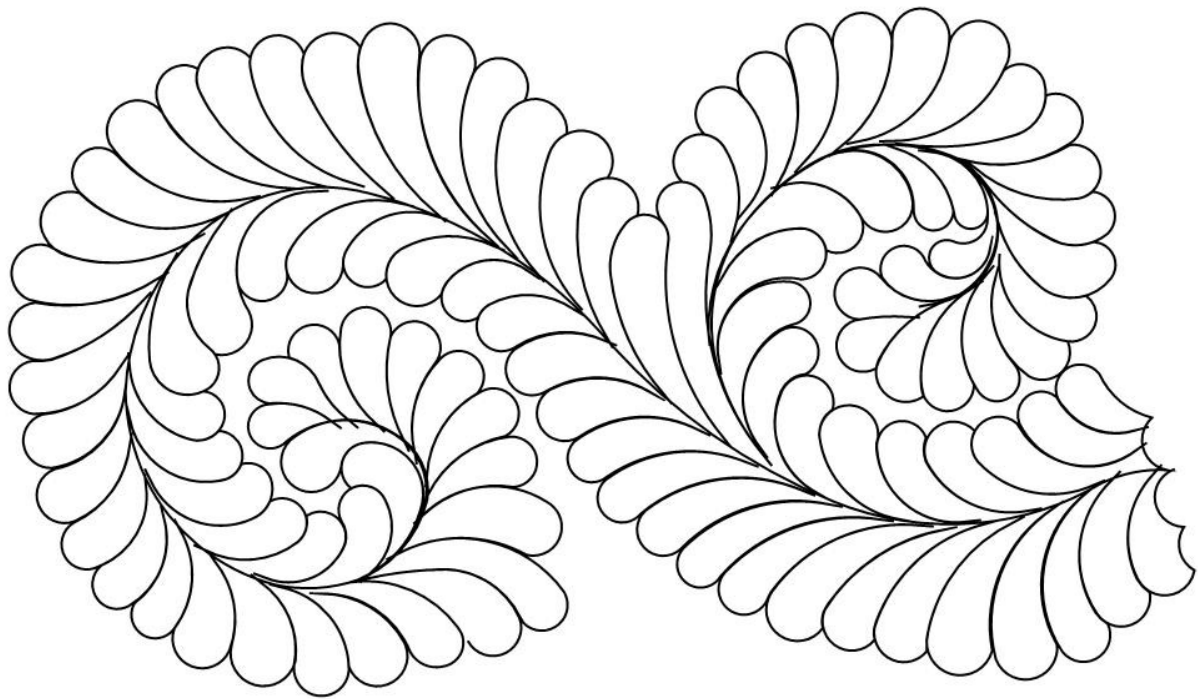

Pattern: feather large brd crn

Archive: Quartz September 2015

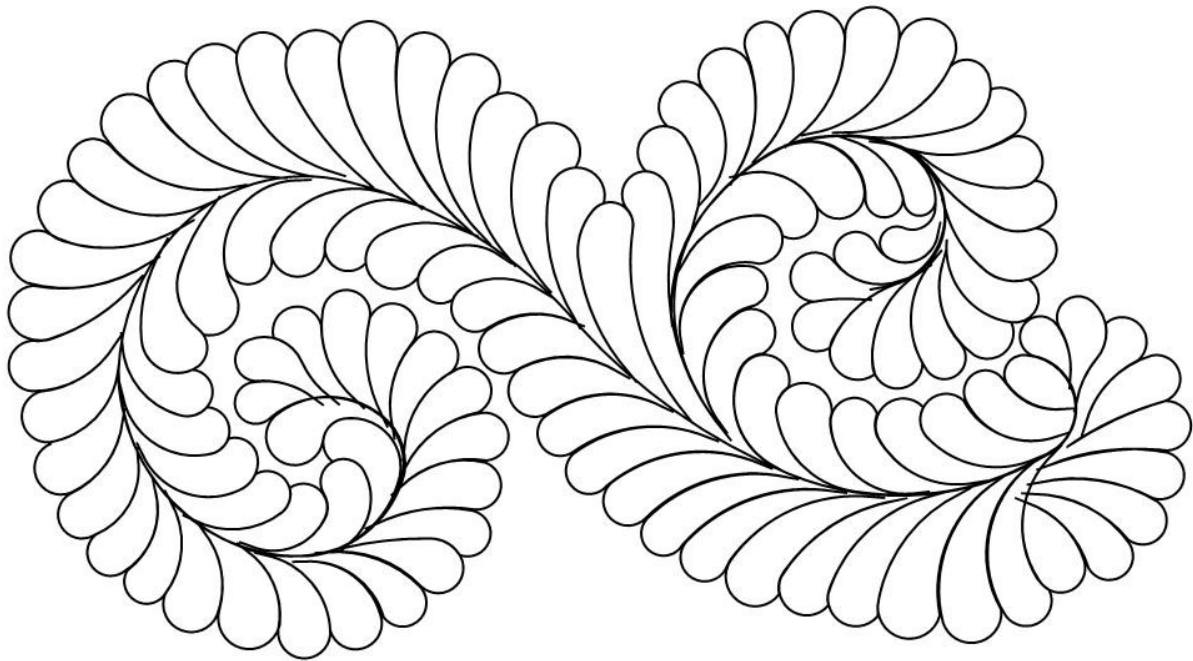

Pattern: feather large brd end

Archive: Quartz September 2015

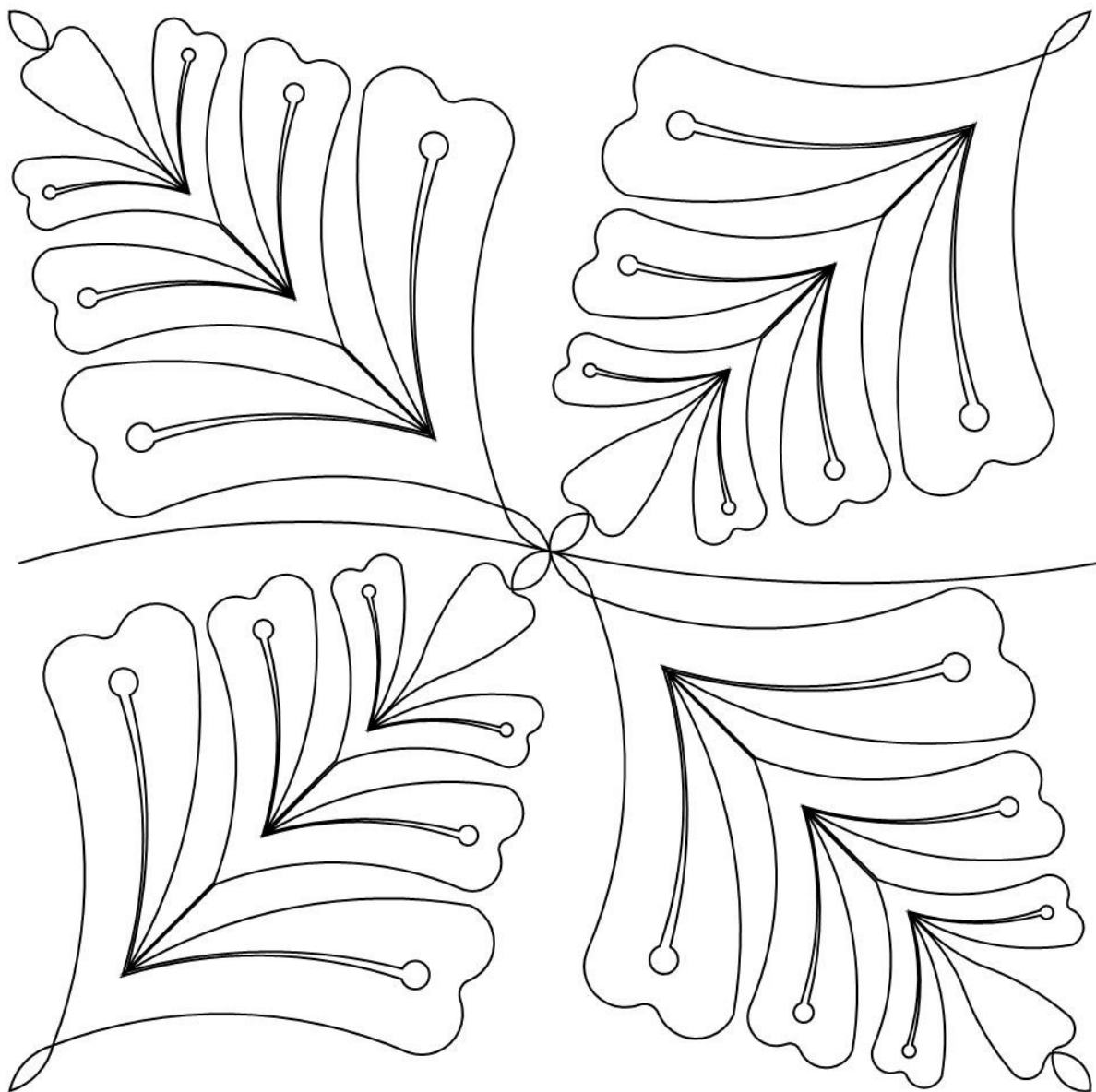

Pattern: feather magic pano 001

Archive: Quartz September 2015

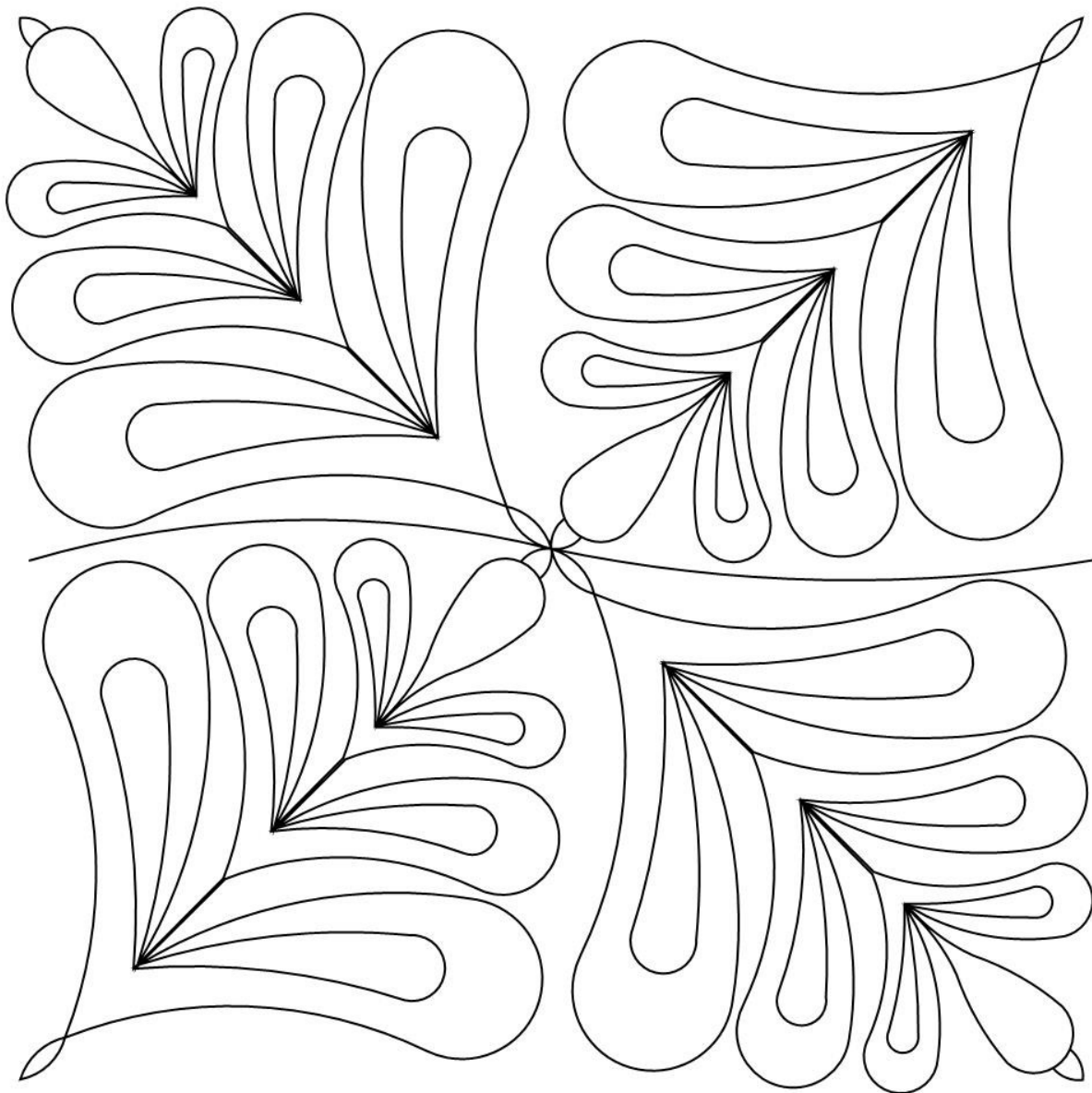

Pattern: feather magic pano 002

Archive: Quartz September 2015

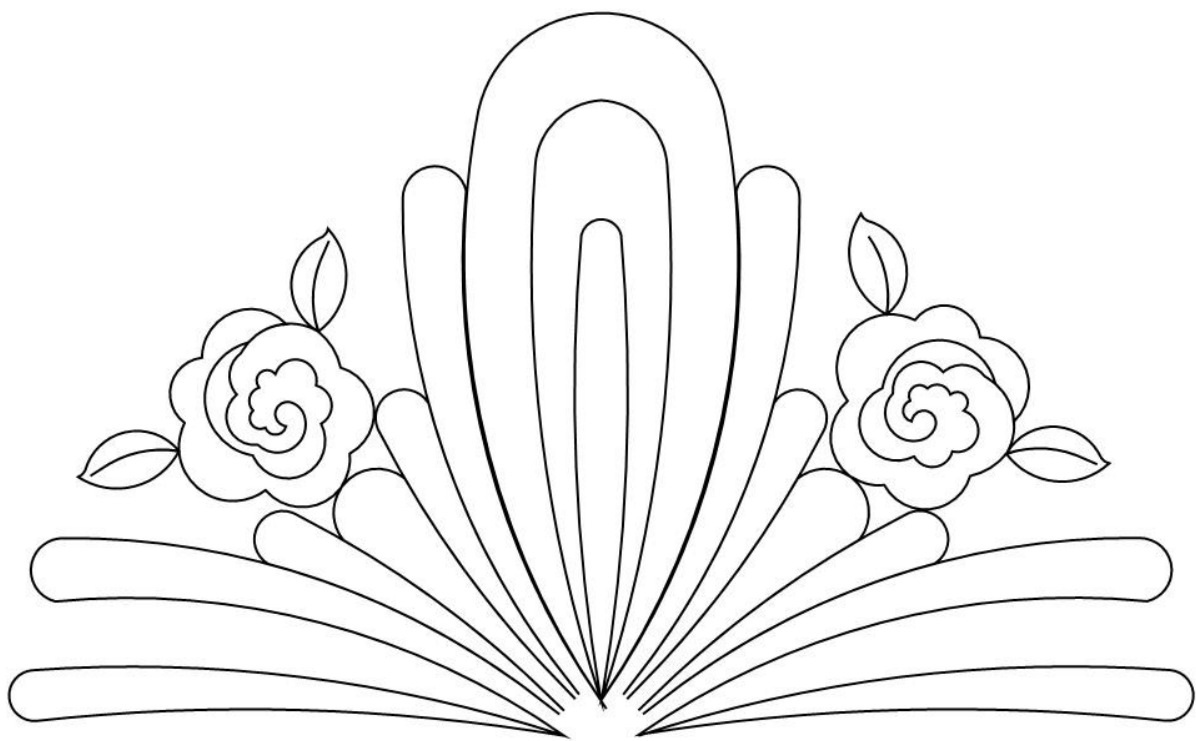

Pattern: feather rosey tri 002

Archive: Quartz September 2015

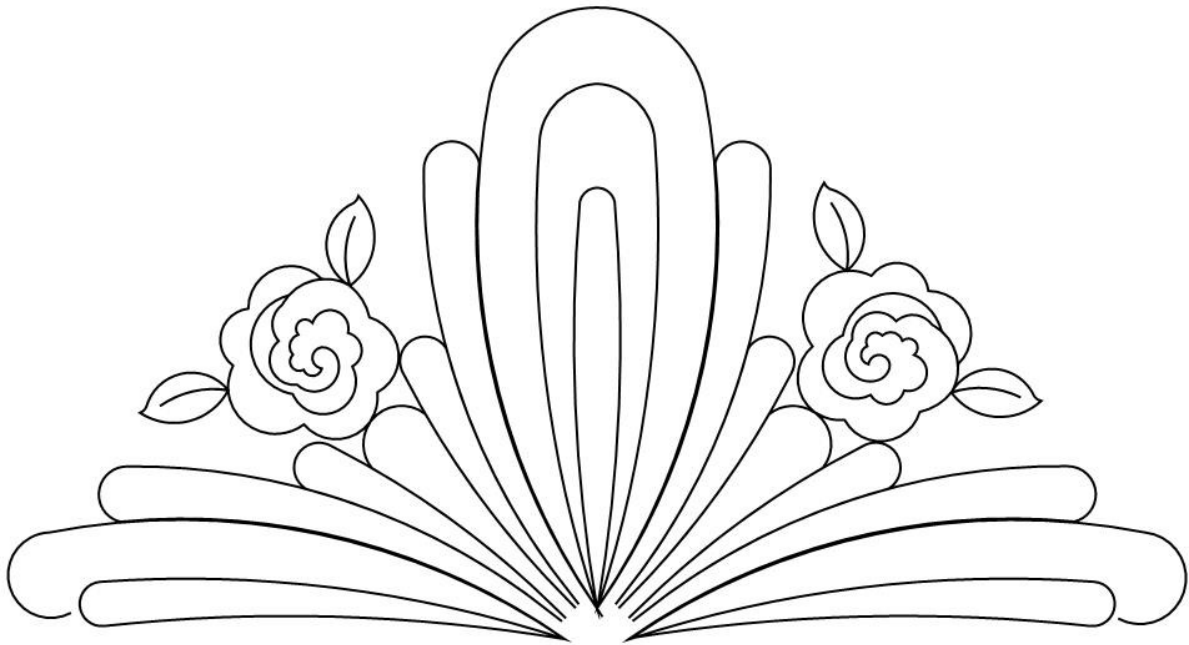

Pattern: feather rosey tri 003

Archive: Quartz September 2015

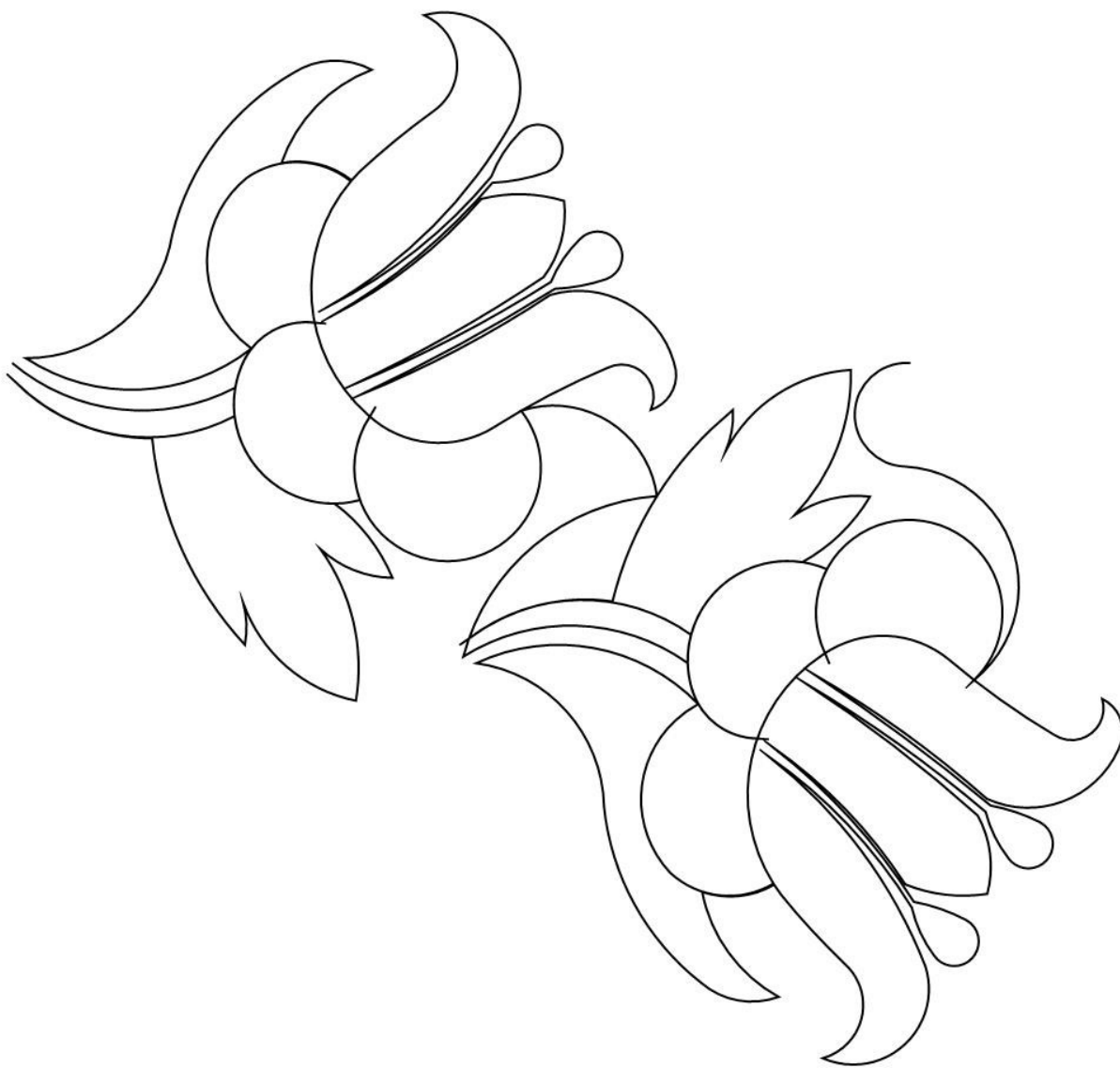

Pattern: floral stripe pano 002

Archive: Quartz September 2015



Pattern: gina flower pano 001

Archive: Quartz September 2015

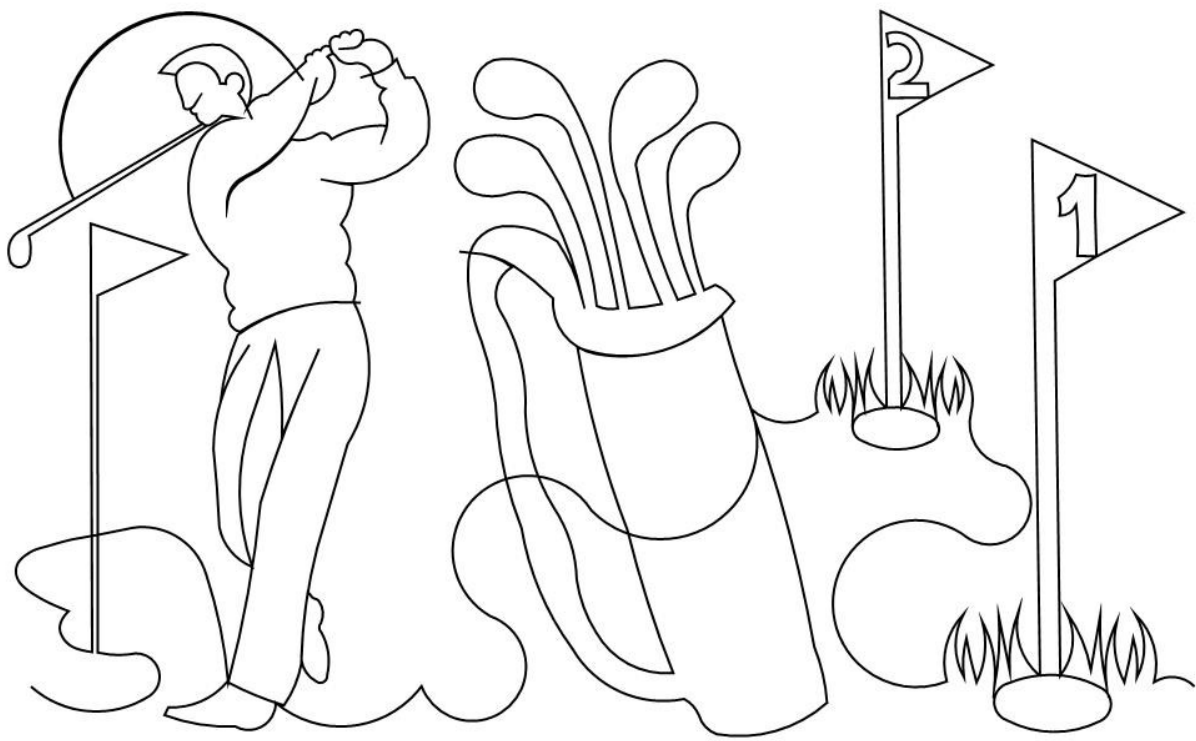

Pattern: golf pano 005

Archive: Quartz September 2015

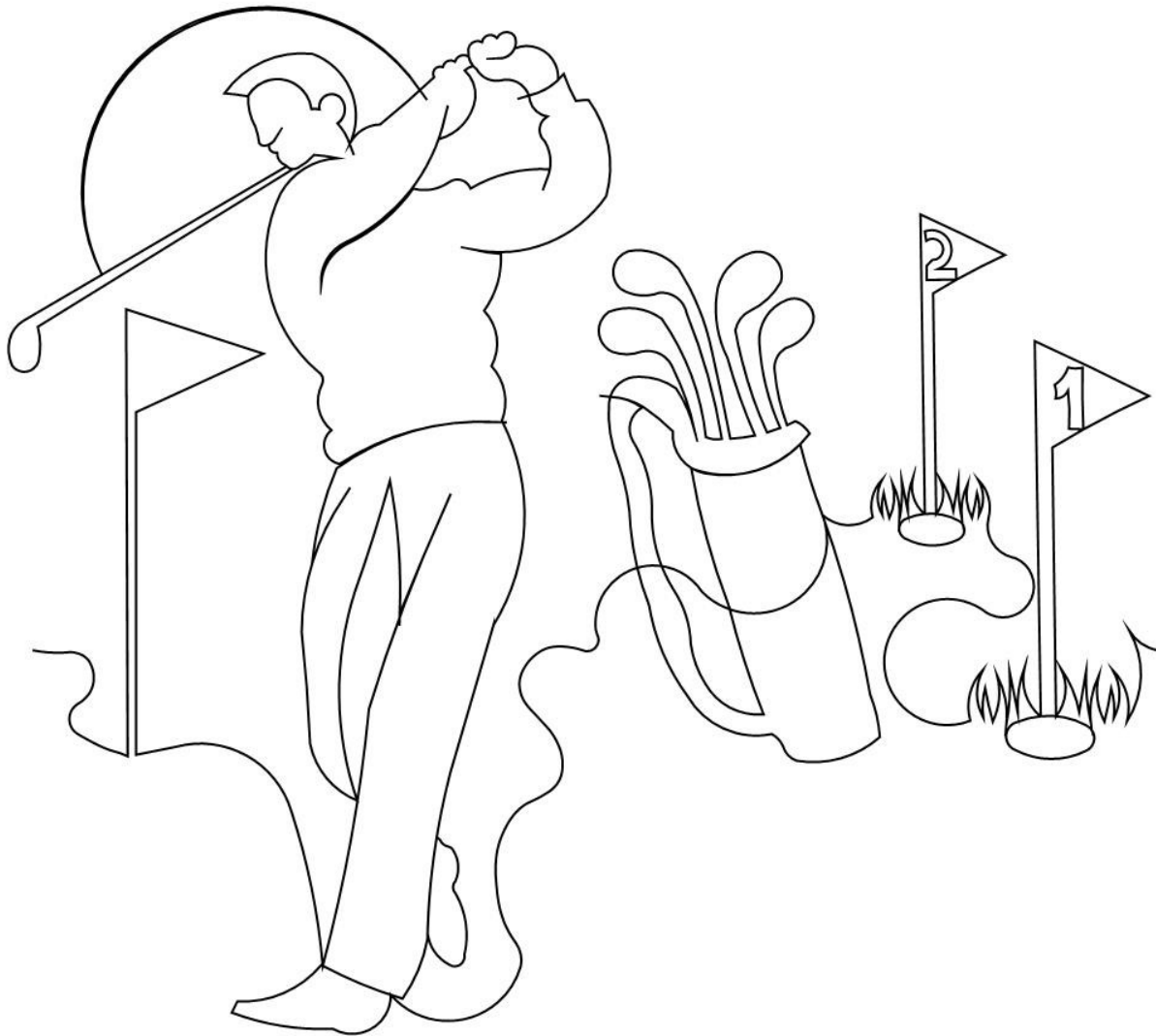

Pattern: golf pano 006

Archive: Quartz September 2015

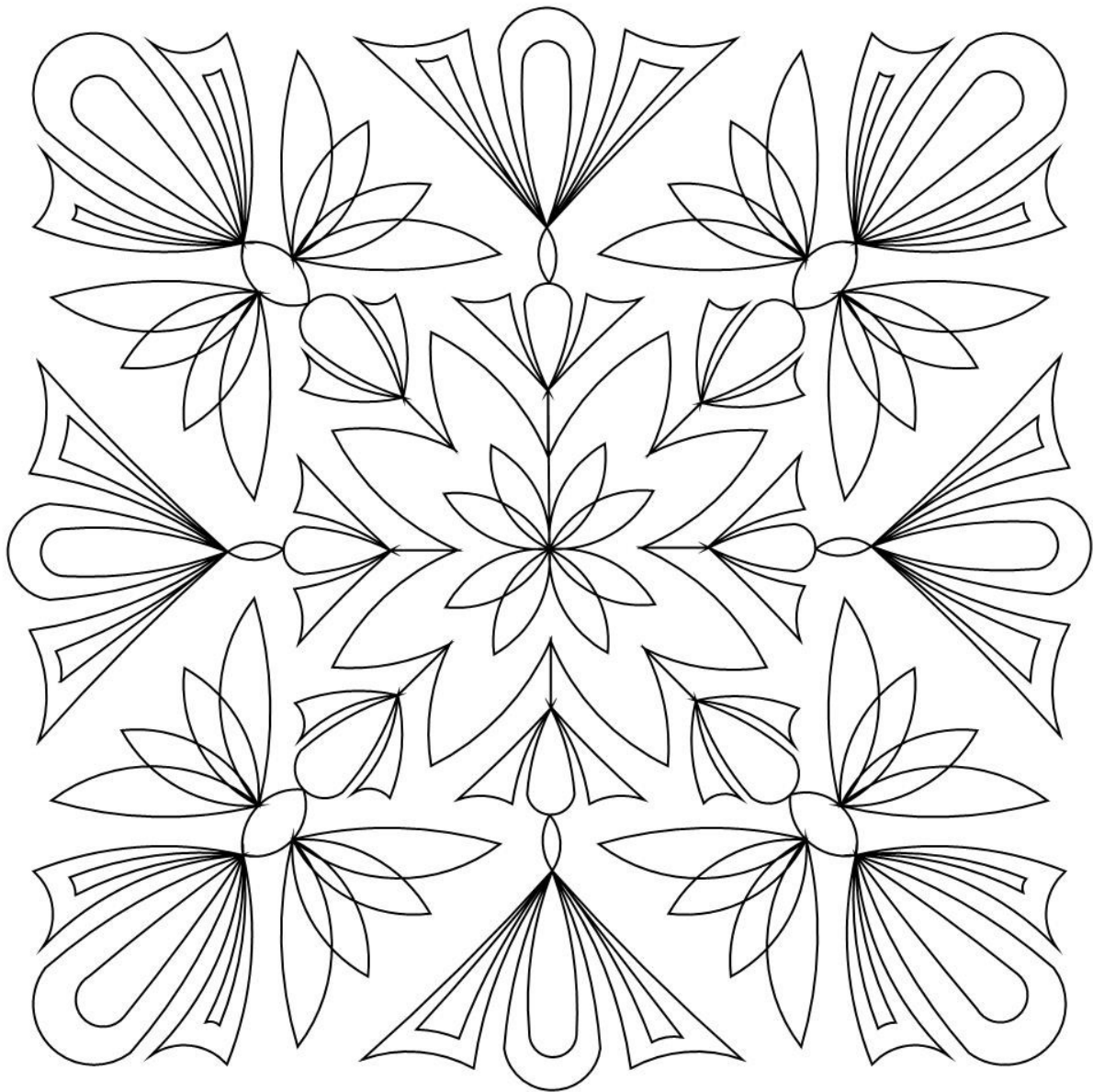

Pattern: gracie sawtooth star 002

Archive: Quartz September 2015

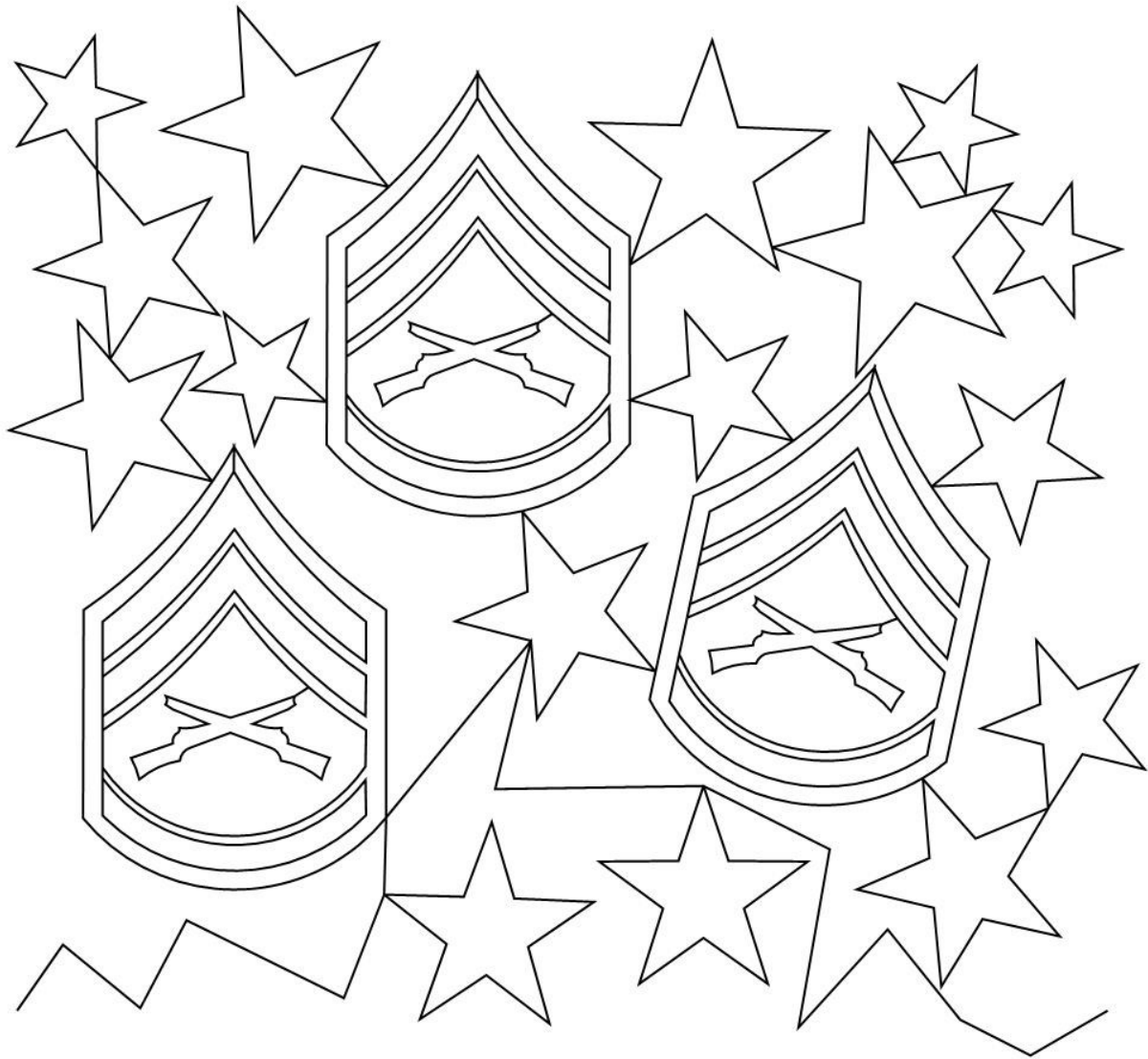

Pattern: gunnery pano 001

Archive: Quartz September 2015



Pattern: heather flower pano 001

Archive: Quartz September 2015

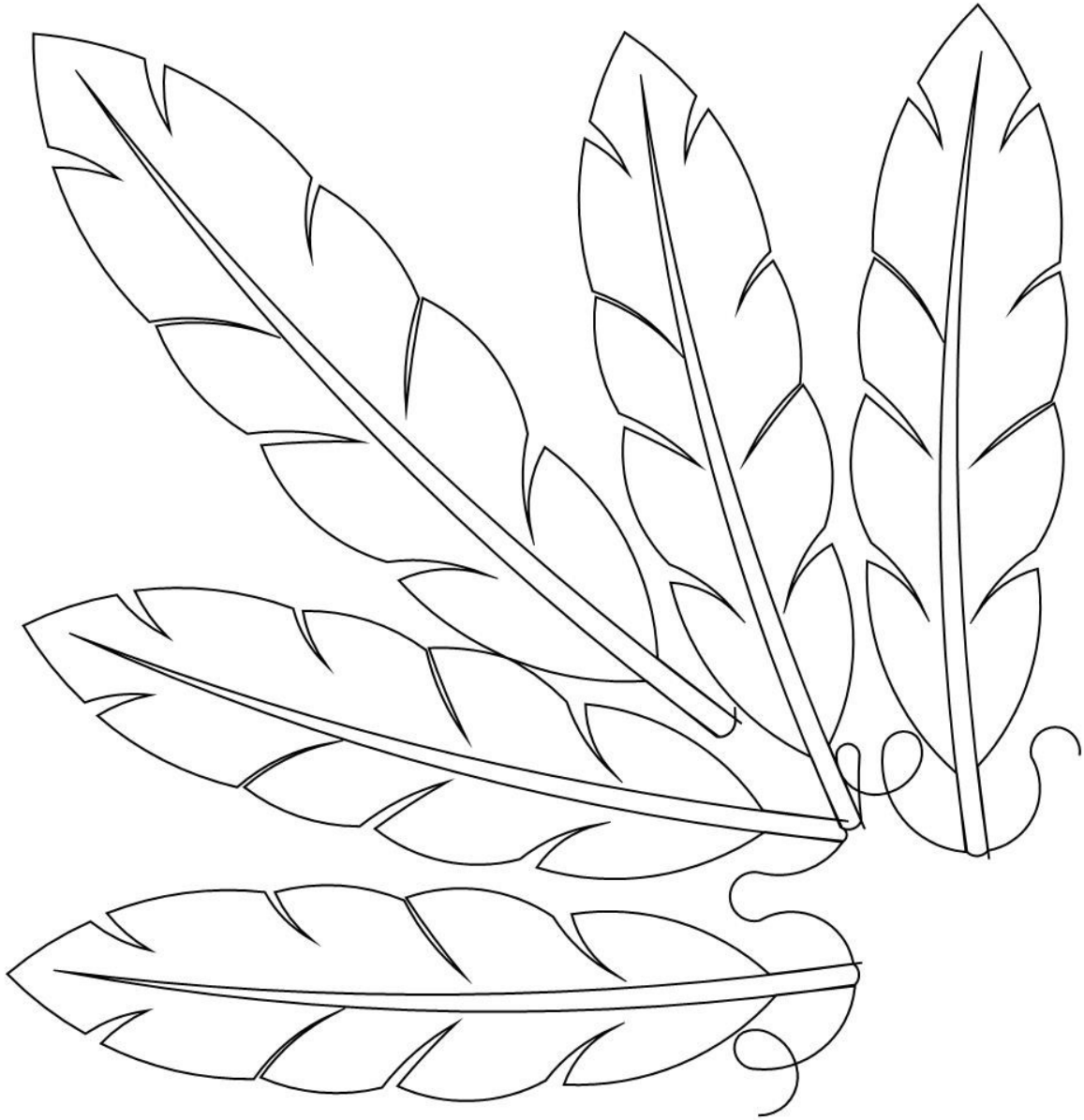

Pattern: indian feather brd crn

Archive: Quartz September 2015

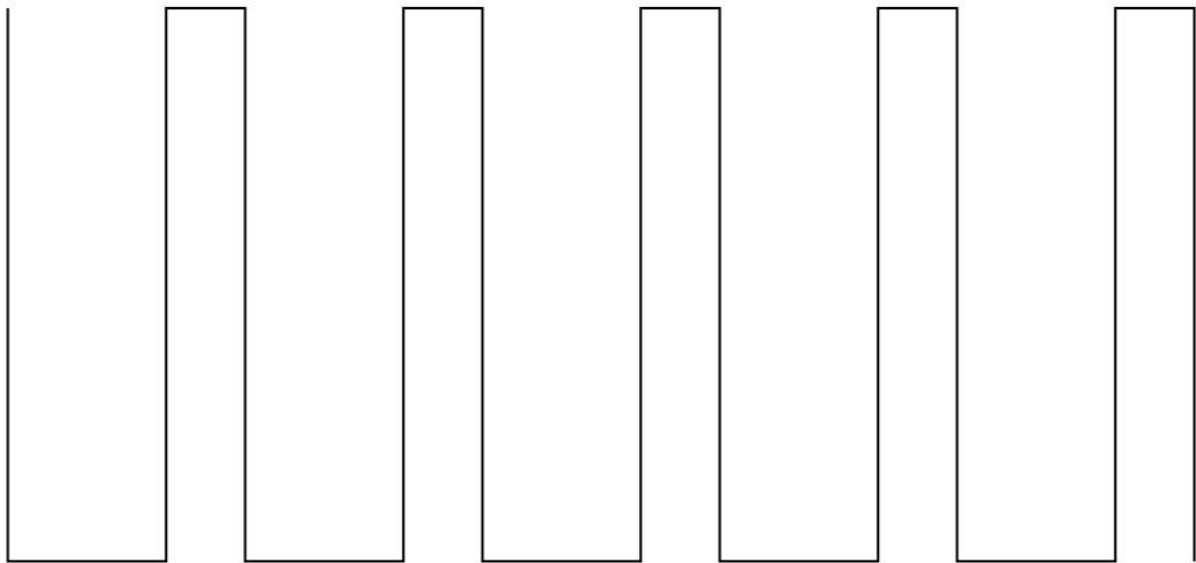

Pattern: janet b rec 1

Archive: Quartz September 2015

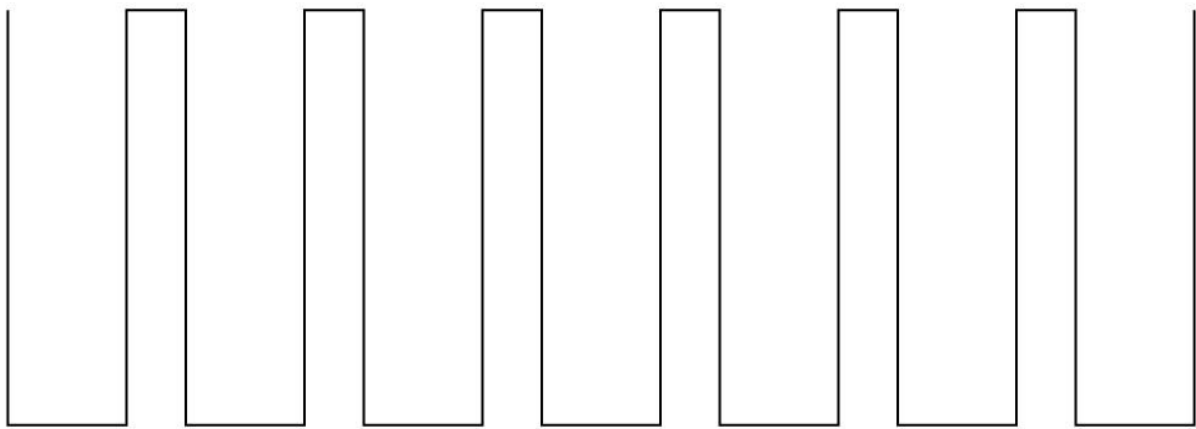

Pattern: janet b rec 2

Archive: Quartz September 2015

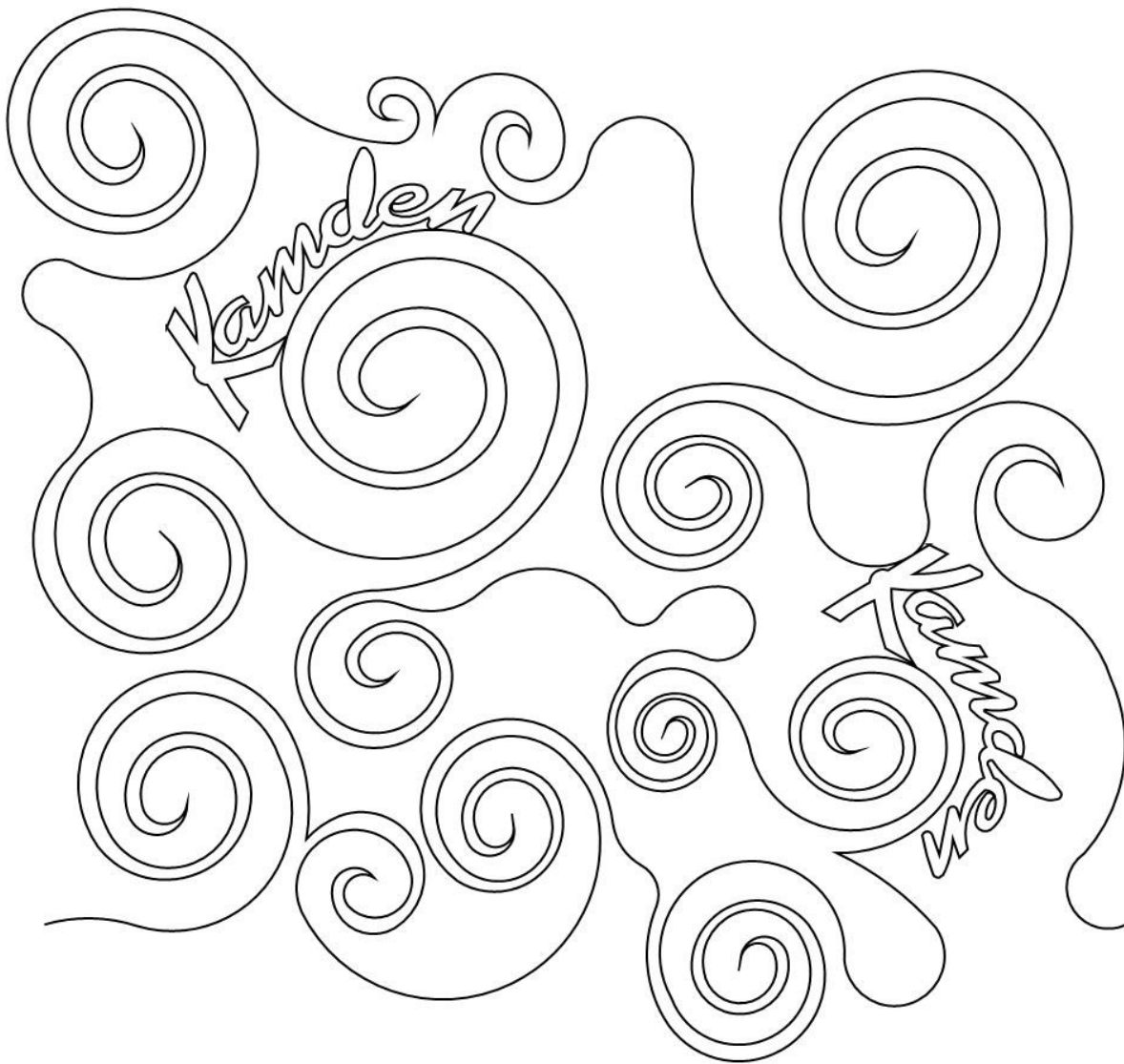

Pattern: kamden pano 001

Archive: Quartz September 2015

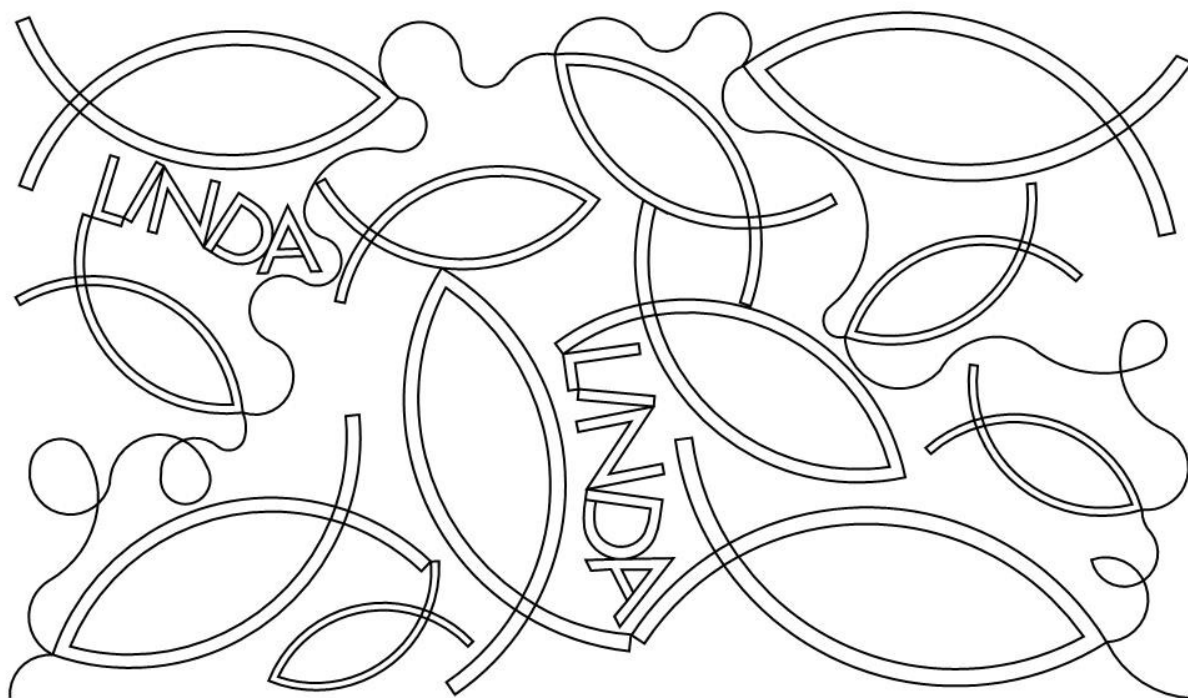

Pattern: linda ichthus pano

Archive: Quartz September 2015

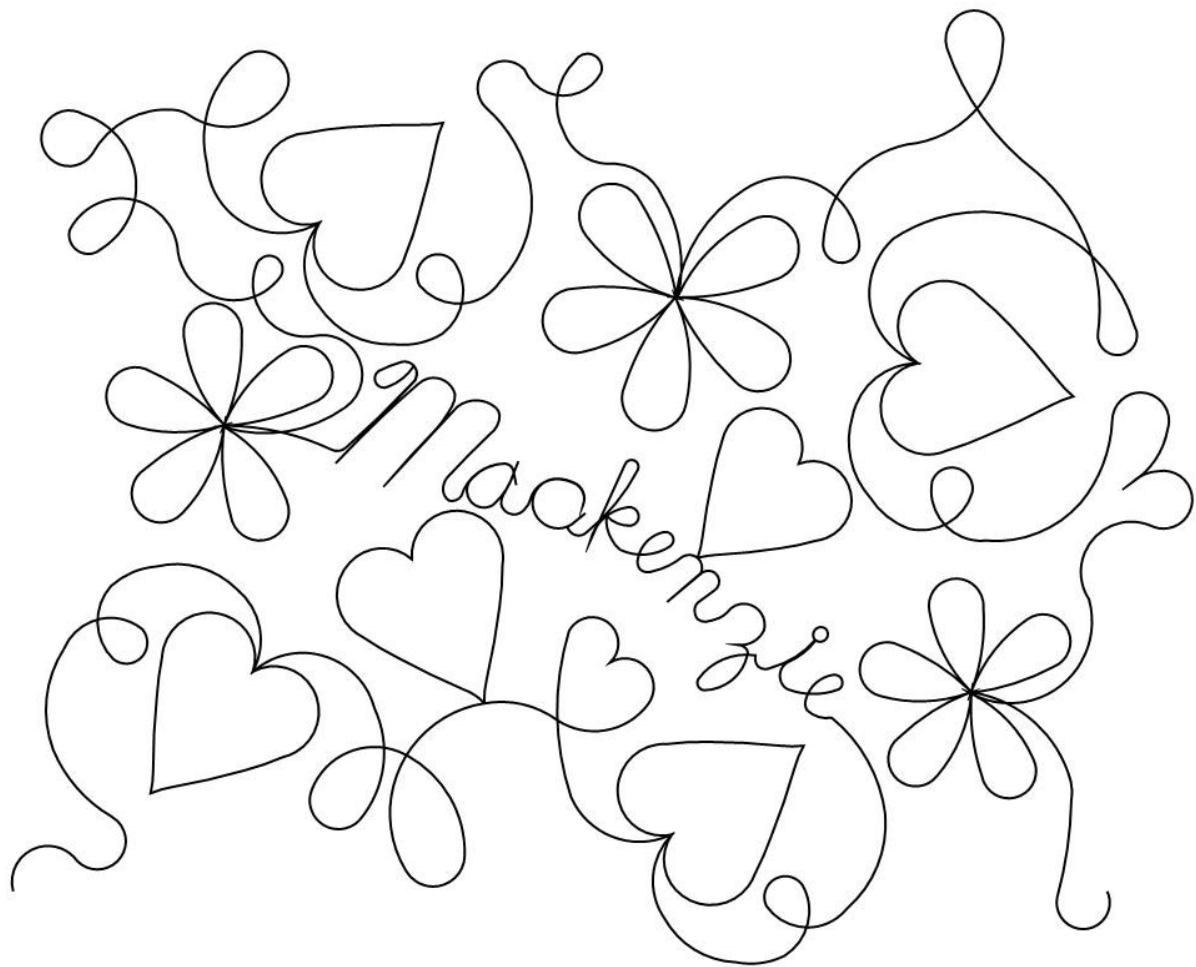

Pattern: mackenzie pano 001

Archive: Quartz September 2015

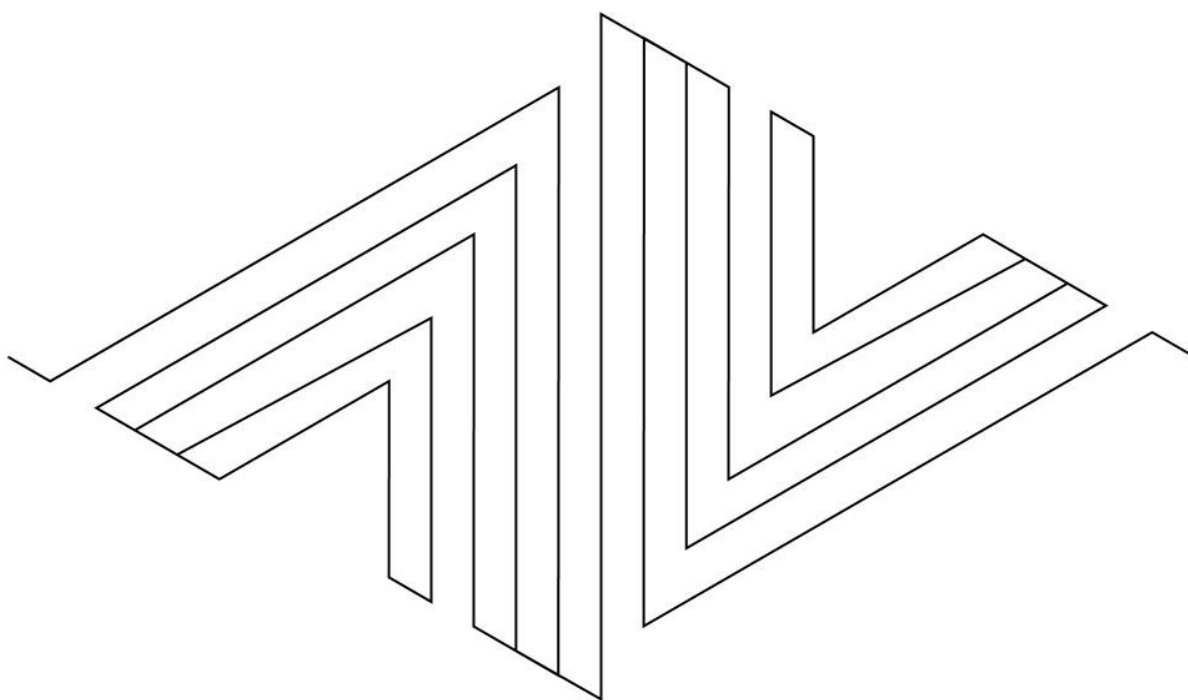

Pattern: p2p 60 diamond 006

Archive: Quartz September 2015



Pattern: ride into the sunset 011

Archive: Quartz September 2015

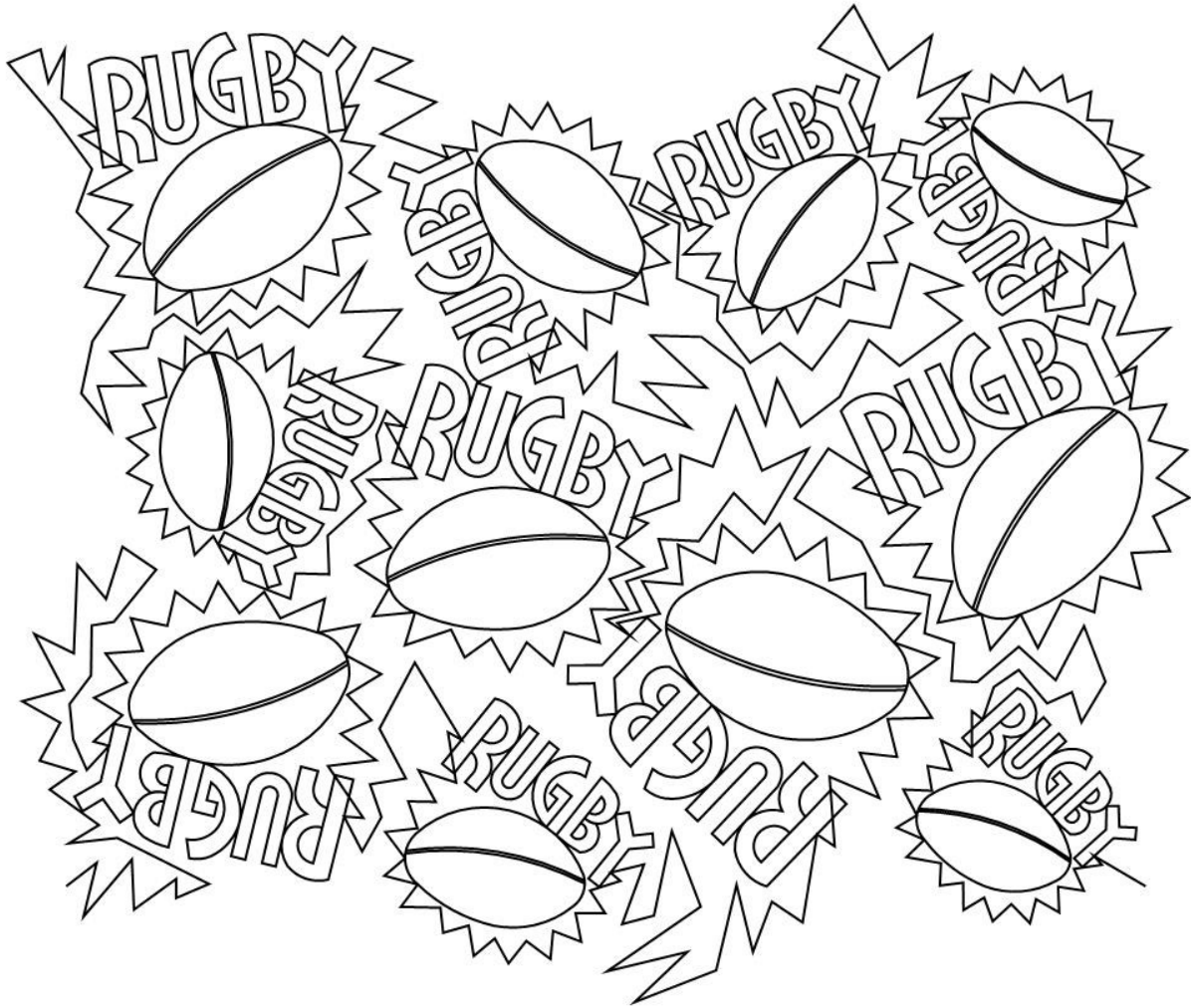

Pattern: rugby pano 002

Archive: Quartz September 2015

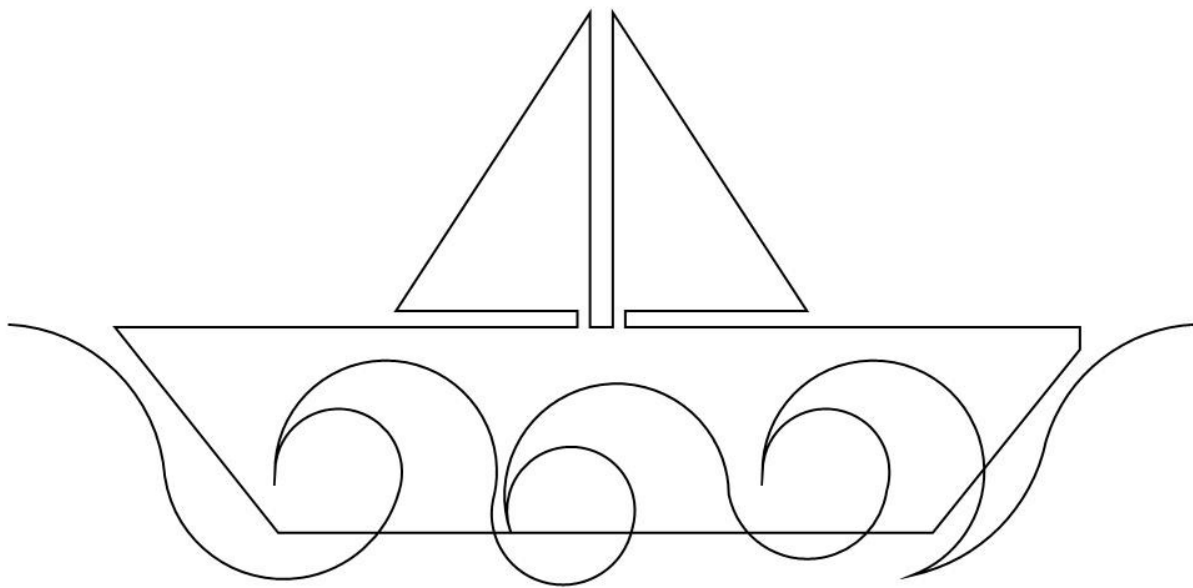

Pattern: sailboat pano 001 alt

Archive: Quartz September 2015



Pattern: sao paulo pano

Archive: Quartz September 2015

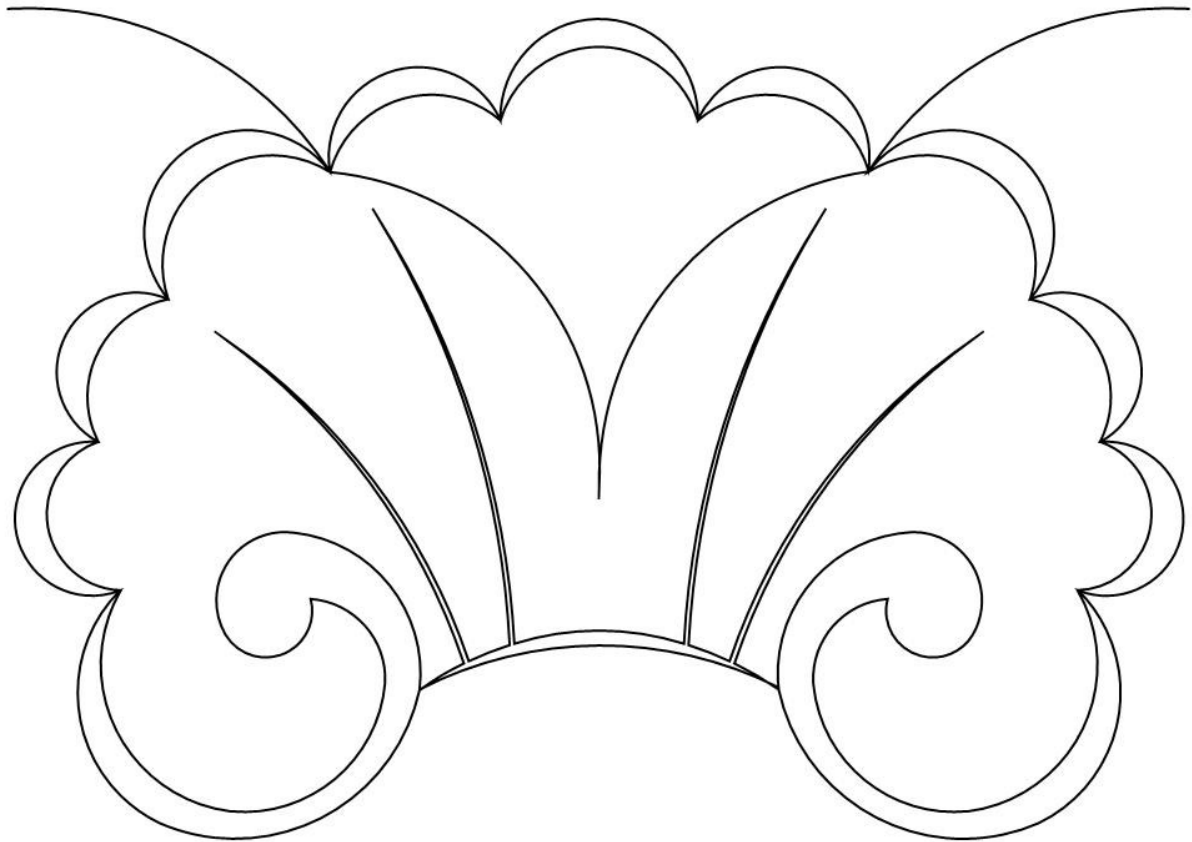

Pattern: scallop shell border 001

Archive: Quartz September 2015



Pattern: scallop shell brd crn 001

Archive: Quartz September 2015

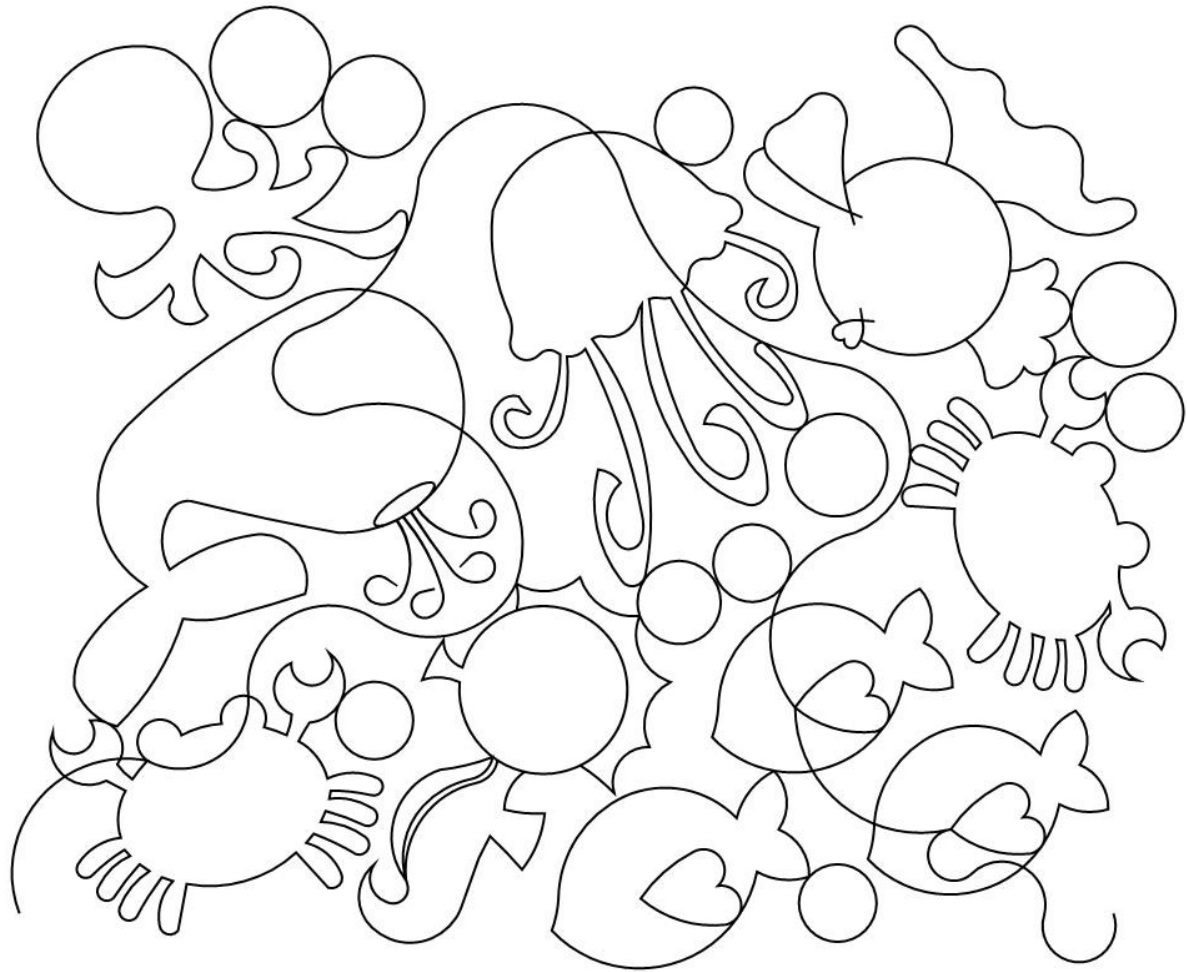

Pattern: sea creature pano 001

Archive: Quartz September 2015

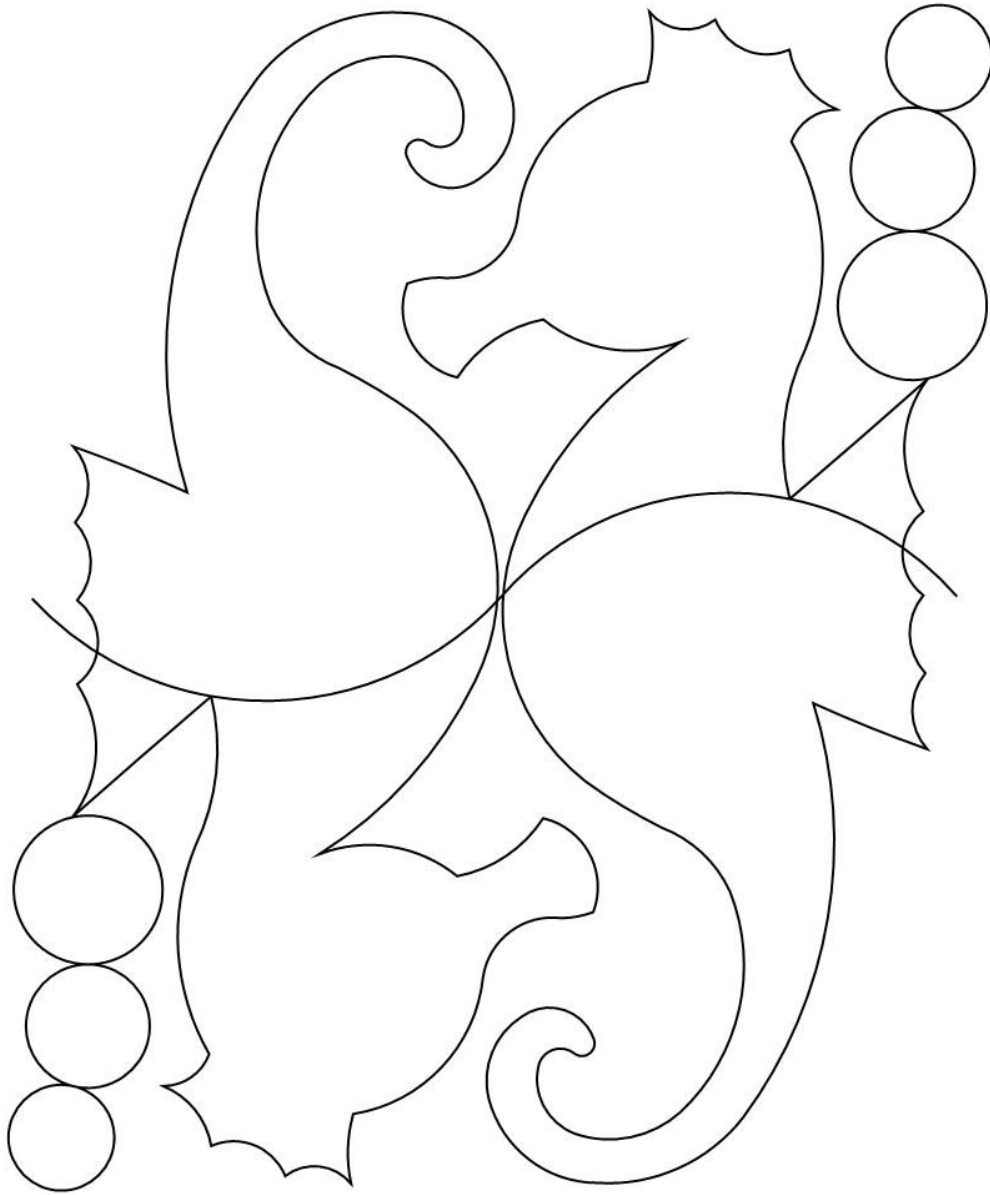

Pattern: seahorse border 001

Archive: Quartz September 2015

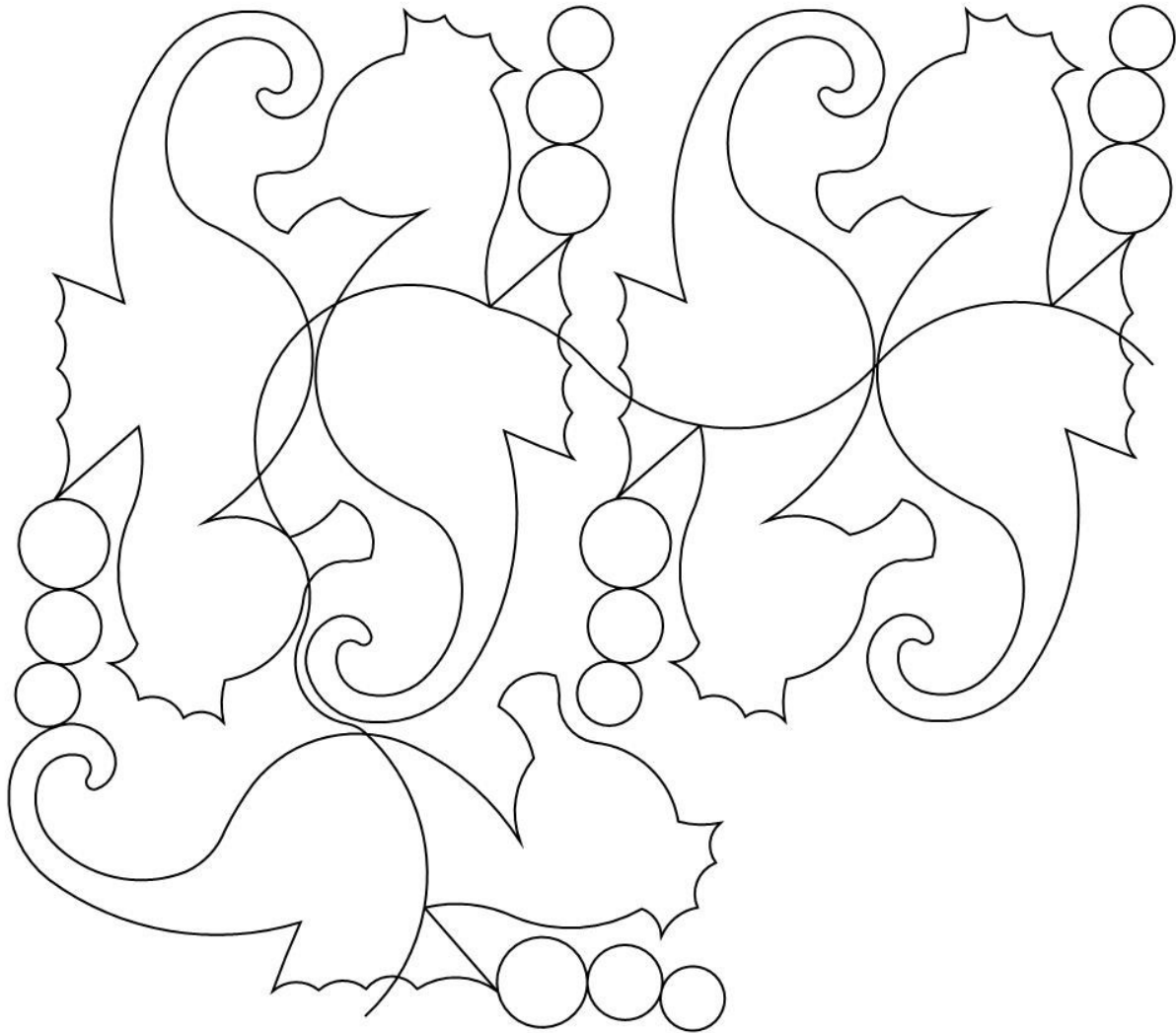

Pattern: seahorse brd crn 001

Archive: Quartz September 2015

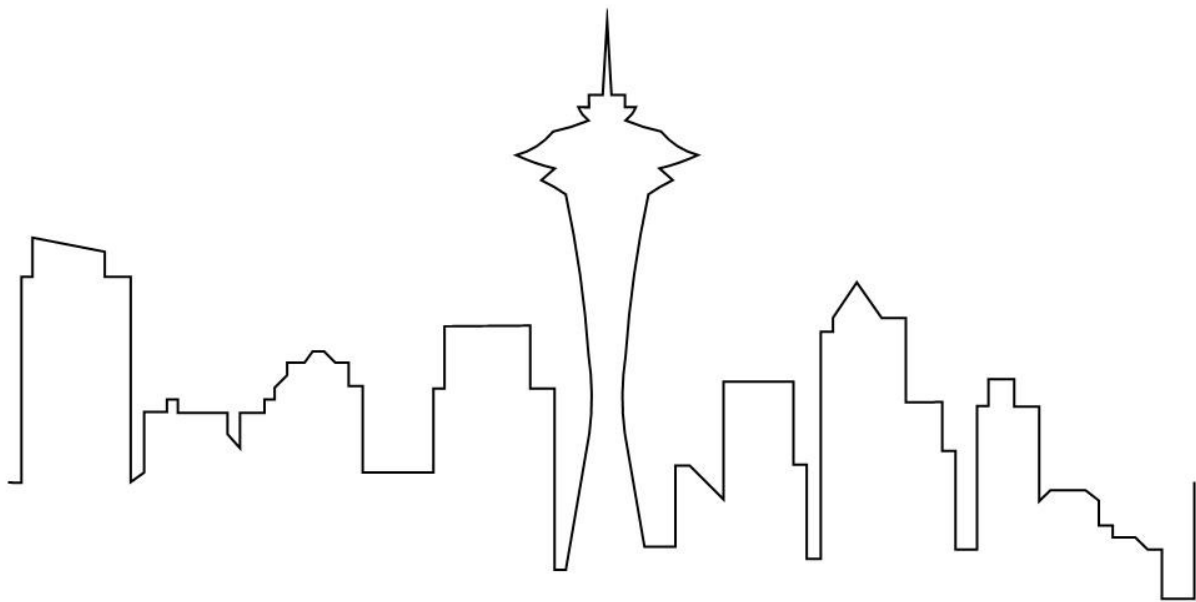

Pattern: seattle skyline border 001

Archive: Quartz September 2015



Pattern: skrunchy lines pano

Archive: Quartz September 2015

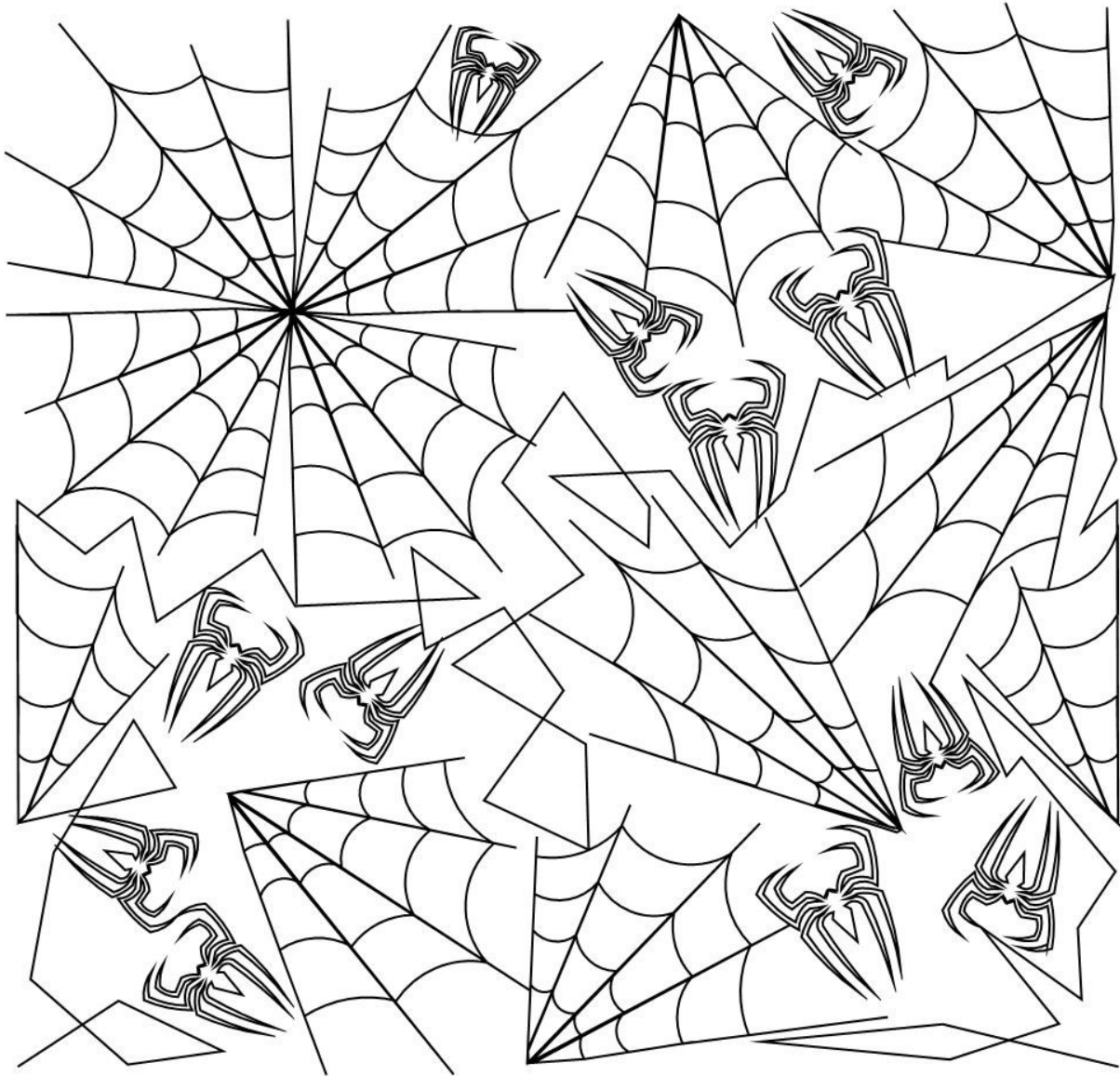

Pattern: spidey pano 002

Archive: Quartz September 2015

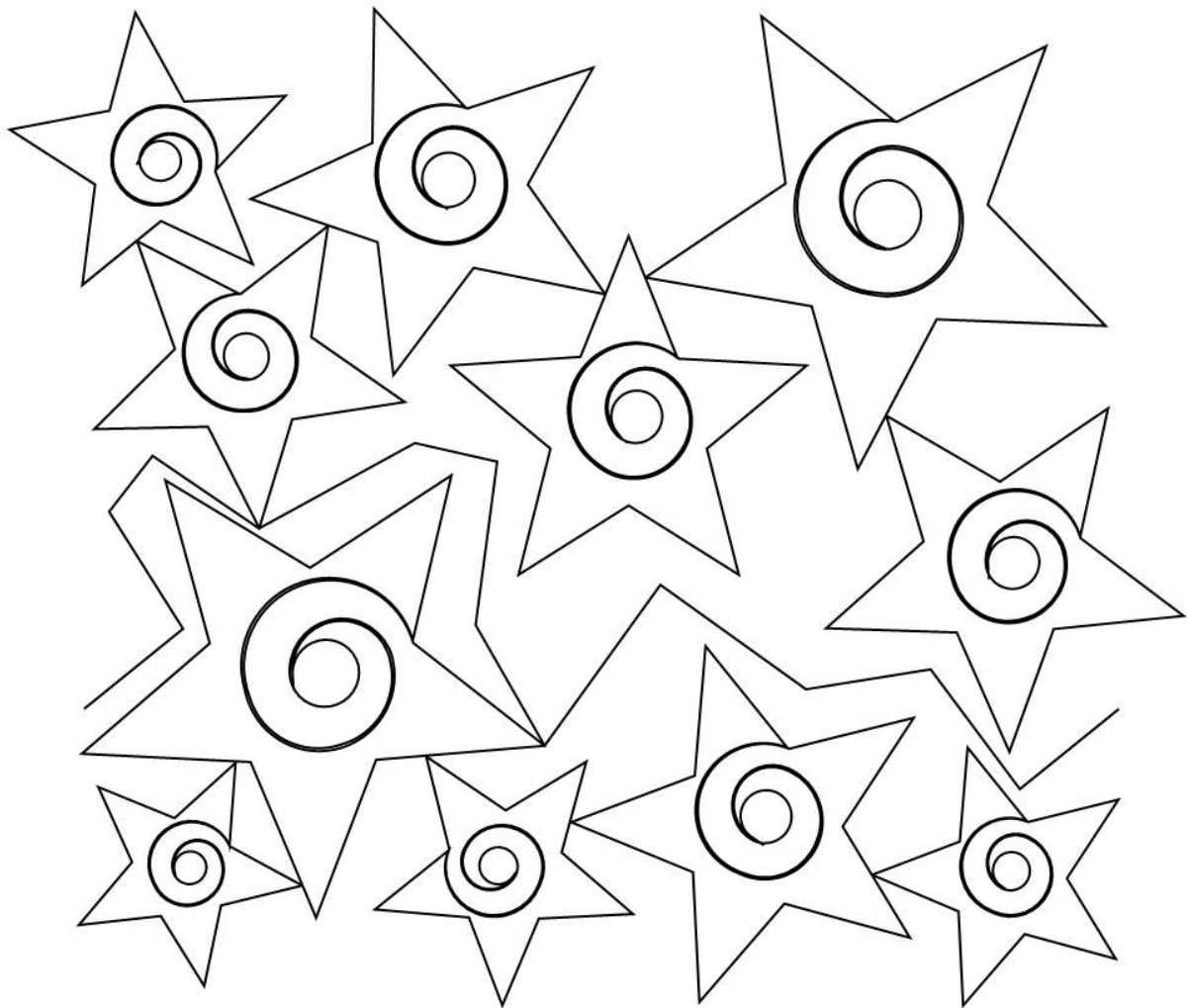

Pattern: star swirl pano 002

Archive: Quartz September 2015

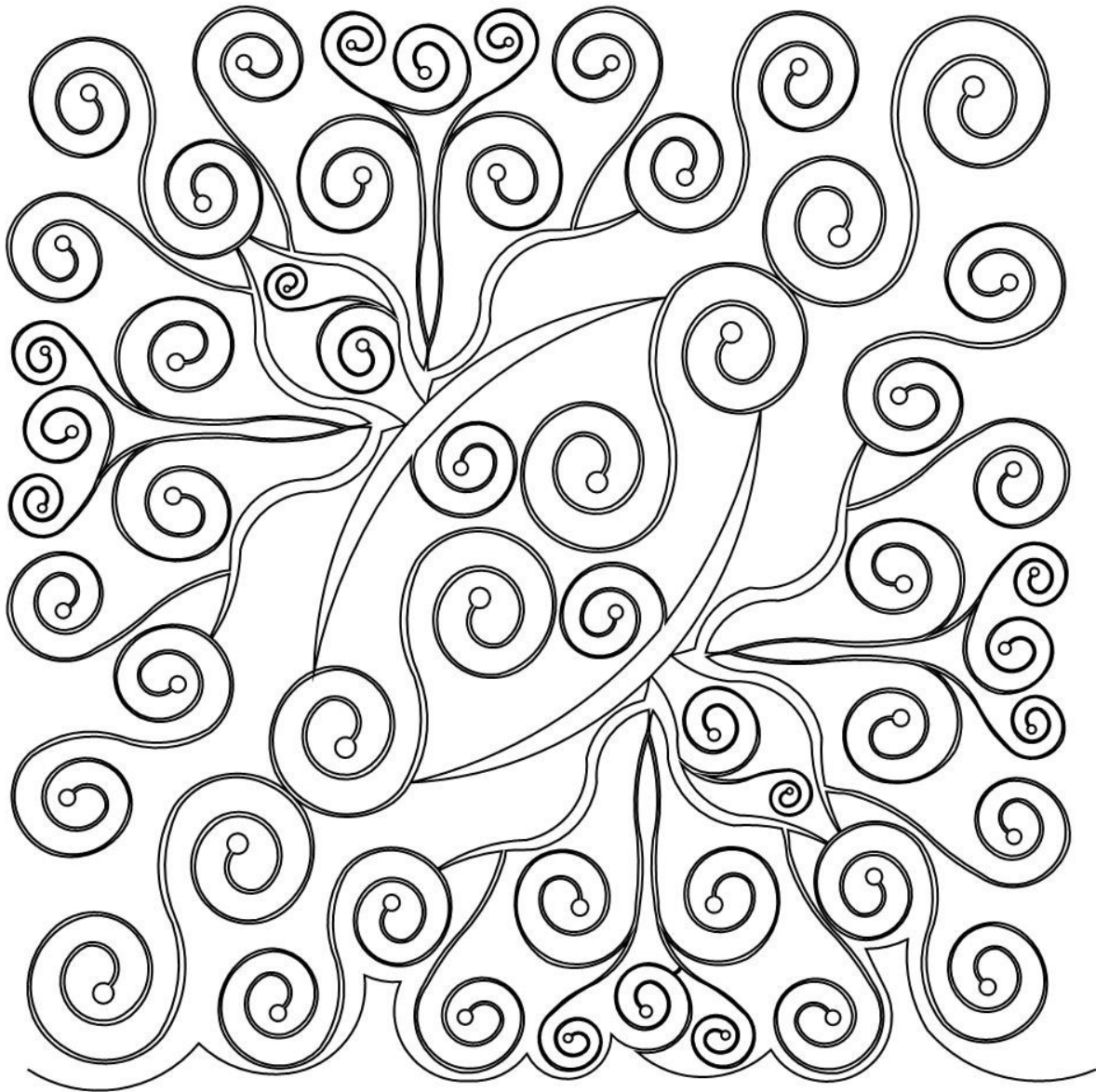

Pattern: sun spirit pano sq

Archive: Quartz September 2015

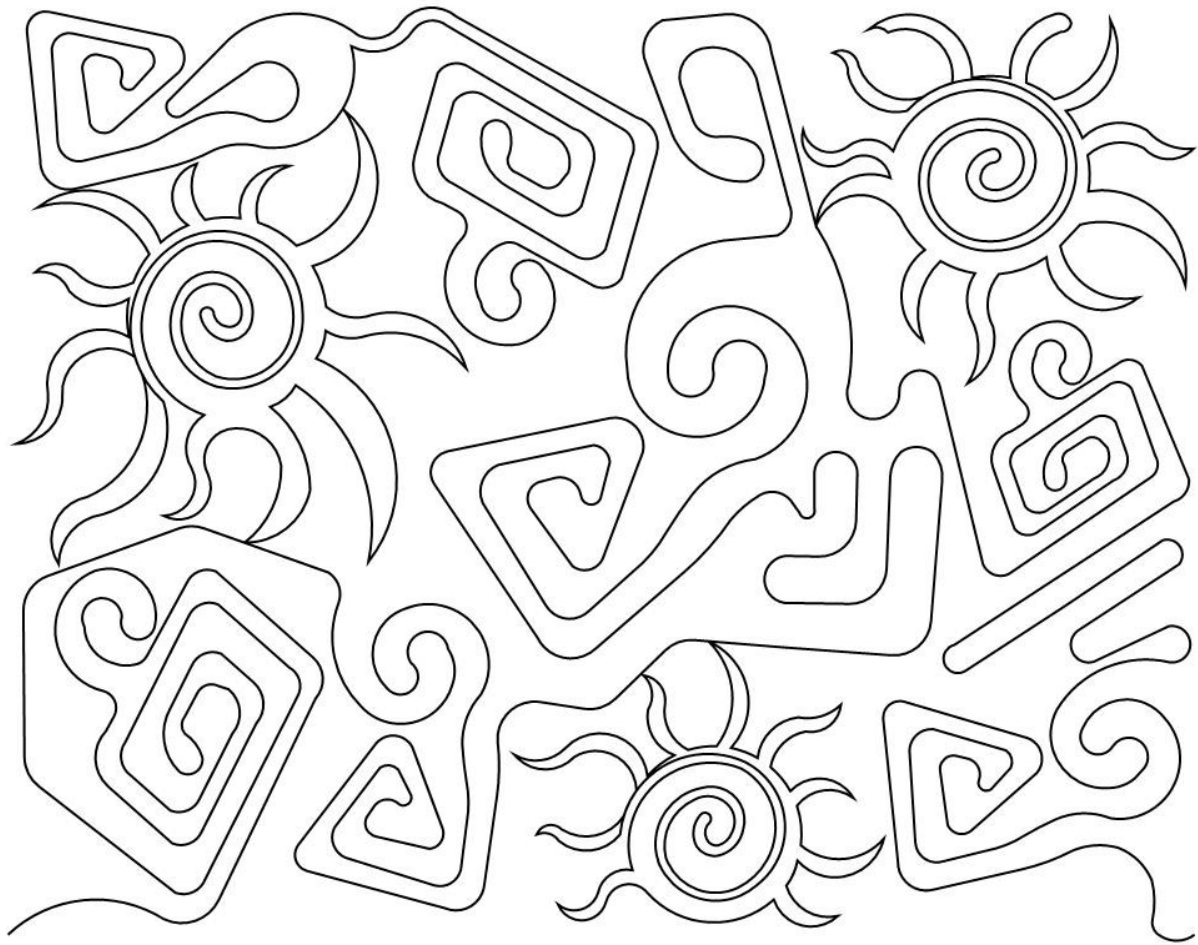

Pattern: sw sun pano 002 sq

Archive: Quartz September 2015



Pattern: tiger pano 002

Archive: Quartz September 2015

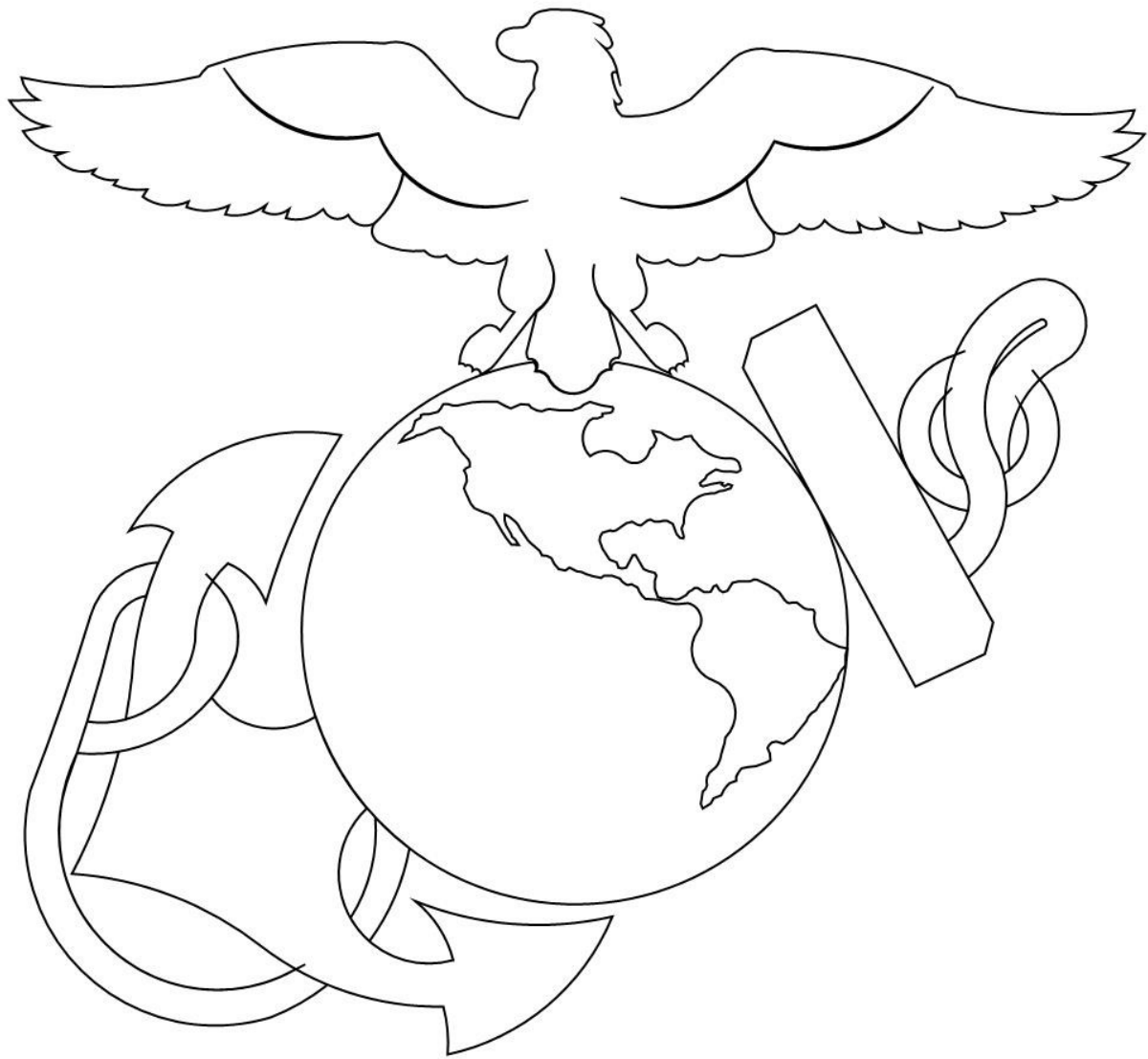

Pattern: usmc logo simple

Archive: Quartz September 2015

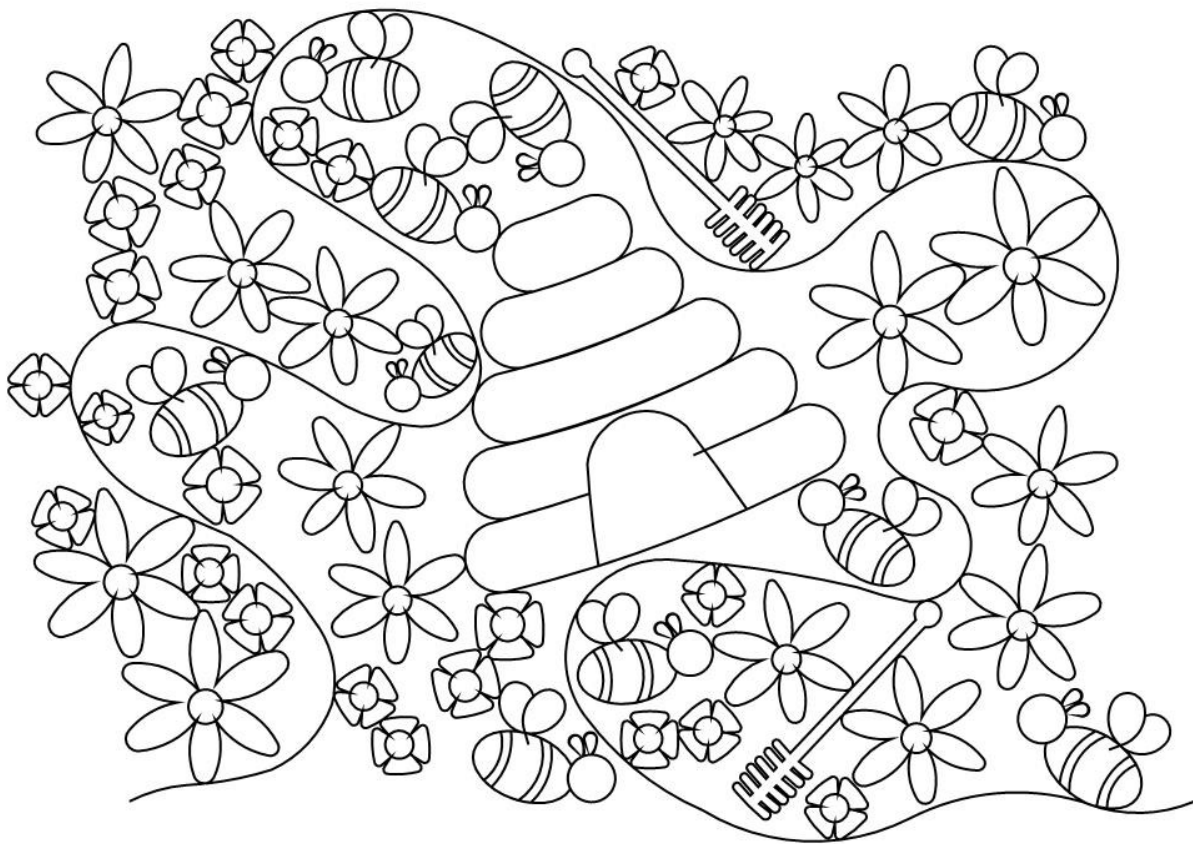

Pattern: whimsical bee pano 002

Archive: Quartz September 2015



Pattern: wolf head 001

Archive: Quartz September 2015

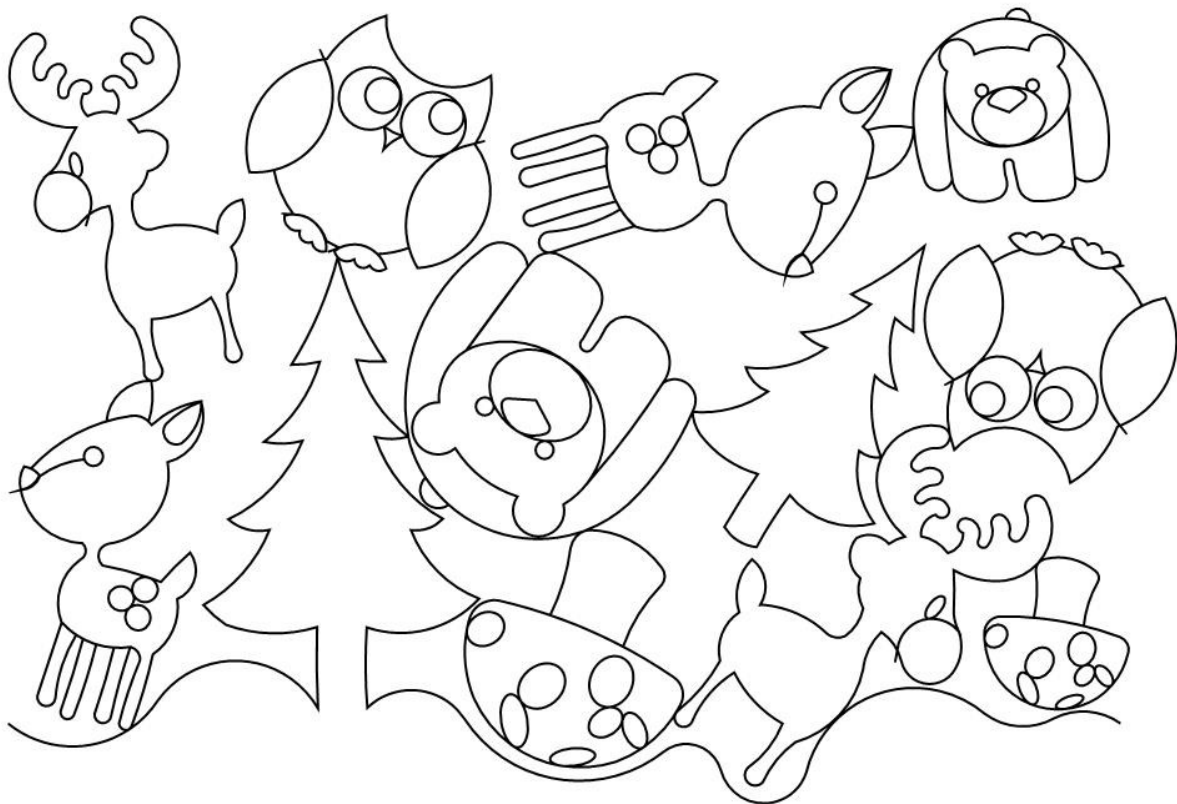

Pattern: woodlands pano 001

Archive: Quartz September 2015

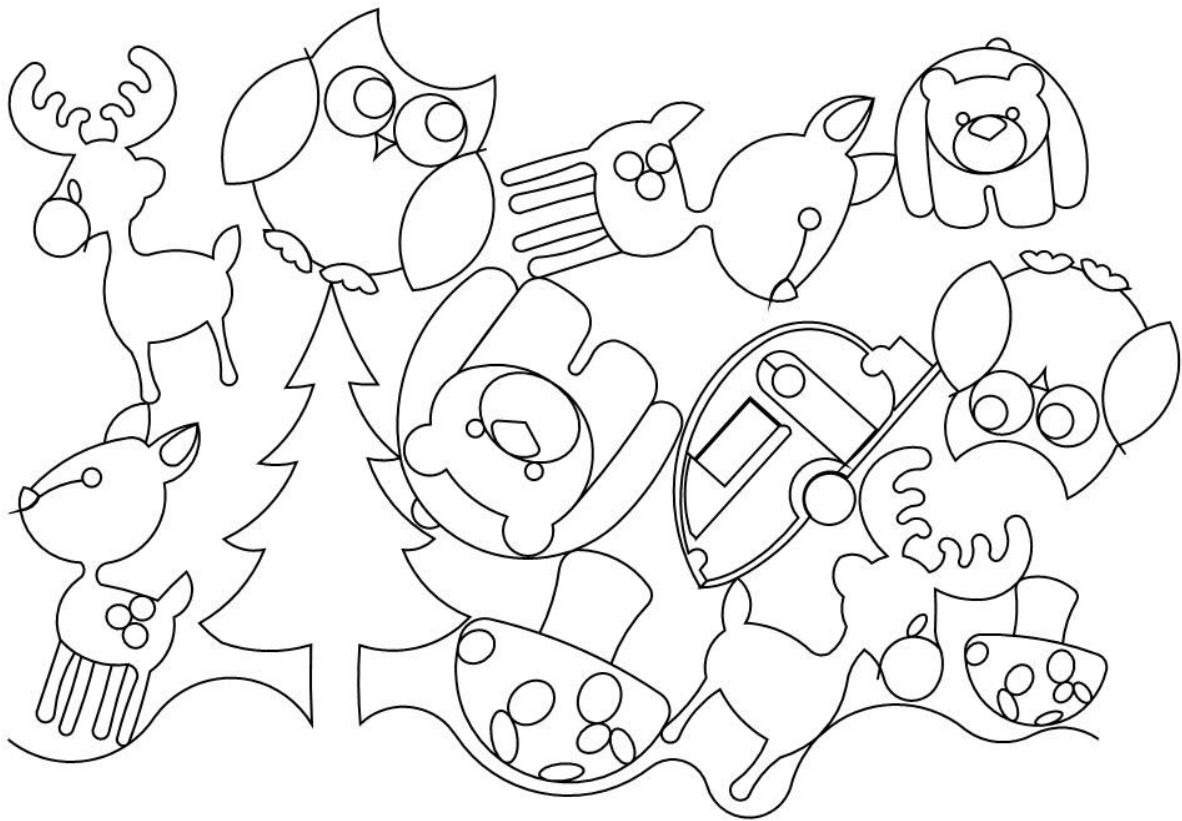

Pattern: woodlands pano 002

Archive: Quartz September 2015

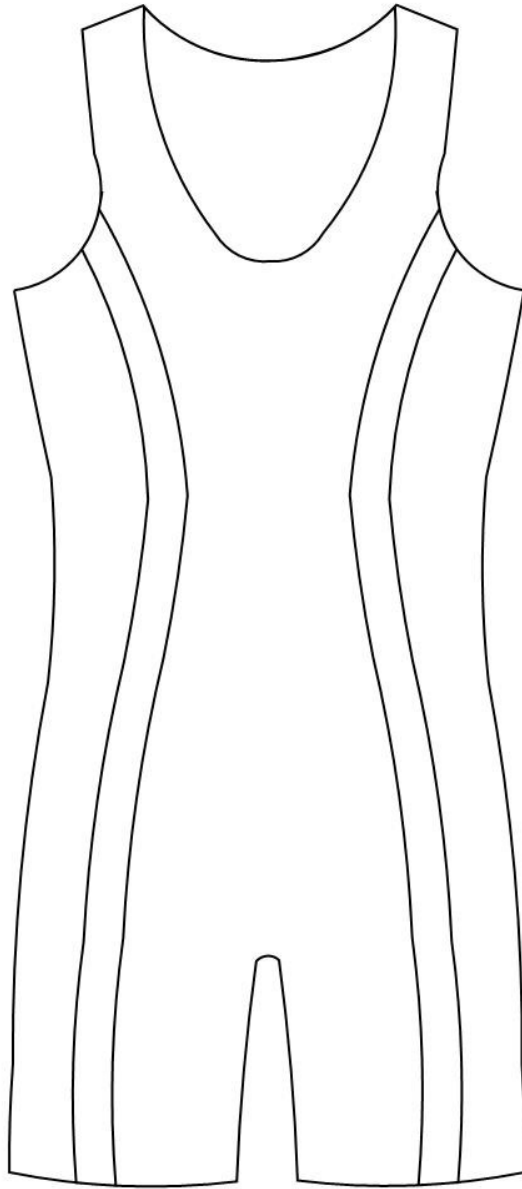

Pattern: wrestling singlet

Archive: Quartz September 2015

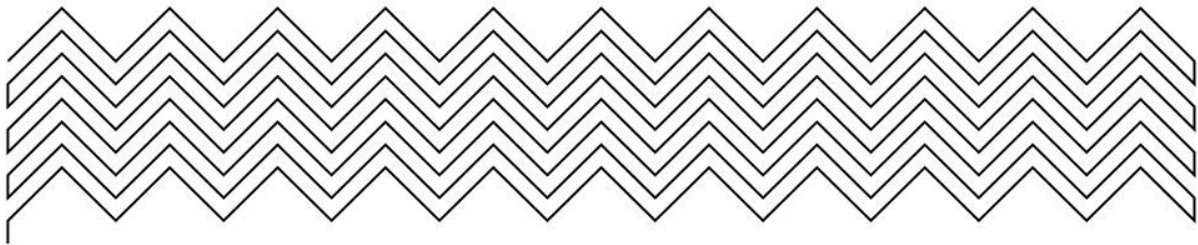

Pattern: zig zag pano 003

Archive: Quartz September 2015